

ROMBINI

design Ronan & Erwan Bouroullec



ROMBINI

design Ronan & Erwan Bouroullec

Rombini è un progetto composto da tre modelli:

piastrella, mosaico ed elemento a rilievo.

È una collezione che presenta una soluzione completa, proponendo differenti abbinamenti;

relazioni ritmiche e colorate che vanno dalla piastrella al mosaico, dal mosaico al rilievo,

dal rilievo alla piastrella.

Rombini is a project consisting of three models:

tiles, mosaics and relief elements.

It seeks to provide a complete response by offering

multiple combinations; rhythmic and colorful blends

which go from the tile to the mosaic, from the mosaic to the relief, from the relief to the tile.

Ronan & Erwan Bouroullec



Ronan e Erwan Bouroullec lavorano insieme da circa 15 anni. La loro collaborazione si sviluppa come un dialogo permanente alimentato dalle loro personalità molto diverse e da un senso del dovere condiviso. Lavorano con numerose aziende, tra le quali Vitra, Kvadrat, Magis, Kartell, Established and Sons, Ligne Roset, Axor, Hay, Nanimarquina, Issey Miyake e Cappellini. Nello stesso tempo, continuano a portare avanti un'attività di sperimentazione, essenziale per lo sviluppo del loro lavoro, presso la Galerie Kreo di Parigi, dove hanno esposto in sei personali tra il 2001 e il 2010. Intraprendono spesso occasionali progetti d'architettura, come ad esempio la Floating House (2006), lo showroom Kvadrat di Stoccolma (2006) e di Copenhagen (2009), i negozi Camper a Parigi e Copenhagen (2009) e il ristorante Dos Palillos, all'interno dell'hotel Casa Camper di Berlino (2010). Molti i premi al loro attivo: designer dell'anno al Salon du Meuble di Parigi nel 2002, Grand Prix du Design (Paris, 1998), il New Designer Award alla ICFF di New York nel 1999, il Finn-Juhl Prize a Copenhagen nel 2008, ben due "Best of the Best" Red Dot Design Award e la Panerai London design Medal nel 2014. Numerose mostre sono state dedicate al loro lavoro: dal 2002 al Design Museum di Londra fino a oggi, nel nuovissimo Centre Pompidou di Metz. Ugualmente le loro creazioni sono parte delle collezioni permanenti di musei internazionali, quali il Musée National d'Art Moderne – Centre Pompidou e il Musée des Arts Décoratifs di Parigi, il Museum of Modern Art (MoMa) di New York, l'Art Institute a Chicago, il Design Museum di Londra e il Museum Boijmans van Beuningen di Rotterdam.

Ronan Bouroullec and Erwan Bouroullec have been working together since around 15 years now. Their collaboration is a permanent dialogue nourished by their distinct personalities and a shared sense of diligence. They design for many manufacturers, including Vitra, Kvadrat, Magis, Kartell, Established and Sons, Ligne Roset, Axor, Hay, Nanimarquina, Issey Miyake and Cappellini. They simultaneously continue their experimental activity which is essential to the development of their work at Galerie Kreo, Paris, where six exhibitions of their designs were held between 2001 and 2010. They also embark on occasional architectural projects such as the Floating House in 2006, the Kvadrat showroom in Stockholm (2006) and Copenhagen (2009), the Camper stores in Paris and Copenhagen (2009) and the Casa Camper Hotel's restaurant, Dos Palillos, in Berlin (2010). Their work has been recognized with many awards including designers of the year at the Paris Salon du Meuble in 2002, Grand Prix du Design, (Paris, 1998), the New Designer Award during ICFF, New York in 1999, the Finn-Juhl Prize, in Copenhagen in 2008, two "Best of the Best" Red Dot Design Awards and the Panerai London Design Medal in 2014. Several exhibitions have showcased their works: from 2002 at the Design Museum in London up to now, at the brand new Centre Pompidou in Metz. Bouroullecs' creations are part of the permanent collections of international museums such as the Musée National d'Art Moderne – Centre Pompidou and the Musée des Arts Décoratifs in Paris, the Museum of Modern Art (MoMa) in New York, the Art Institute in Chicago, the Design Museum in London, and the Museum Boijmans van Beuningen in Rotterdam.



5 COLOURS

“Rombini è un alfabeto di forme e di colori.”

Rombini è un racconto ceramico, un percorso di ricerca,
un’ esplorazione nel mondo del colore.

La collezione è declinata in grey, blue, green, red e poi c’è il bianco,
un passe-partout per creare infinite combinazioni con le altre tinte.

“Rombini is an alphabet of shapes and colours.”

Rombini collection is about a ceramic story, a research path,
an exploration within the colours field. The collection is declinated in
grey, blue, green, red and then white, a passe-partout to create endless
combinations with the other shades.



3 ELEMENTS

Rombini è un vero e proprio progetto di interior design fondato sul colore e declinato in tre elementi: **CARRÉ**, **LOSANGE** e **TRIANGLE**. Carré, lastre in gres porcellanato in formato 40x40, caratterizzate da un pattern formato da tanti piccoli rombi a rilievo su una superficie matt che conferisce una forte identità ceramica alla collezione. Carré è realizzata in due versioni: Uni, dove il colore è distribuito uniformemente su tutta la lastra, e Light, dove il colore viene usato per evidenziare i contorni dei rombi bianchi. Con Losange, il rombo diventa tessera di un mosaico e assume una dimensione più grande. Realizzata in gres porcellanato a doppio caricamento, ogni tessera è composta su fogli da 27,5x25,7 cm. La gamma cromatica risulta intensa e profonda, grazie alla superficie matt che conferisce naturalità al prodotto. Anche in questo caso l'elemento è raccontato in due versioni, attraverso l'uso dello stucco in tono su tono o a contrasto, per una vibrazione più decisa. Grazie al Triangle la forma del rombo viene interpretata nella sua tridimensionalità, al fine di creare giochi di luce e di ombra sulla parete. Gli elementi, realizzati nelle versioni Large e Small, sembrano emergere dal pavimento e proseguire a rivestimento.

Rombini is a real interior design project, based on colour and composed by three elements: **CARRÉ**, **LOSANGE** and **TRIANGLE**. Carré, 40x40 rectified slabs in glazed porcelain stoneware, are produced on a mould made of many little embossing diamonds on a matt surface which gives a strong ceramic identity to the collection. Carré is available in two versions: Uni, where colour is evenly distributed throughout the whole slab, and Light, where colour is used to underline the white diamonds outlines. With Losange, the shape of the rhombus becomes bigger and turns into a chip of a mosaic. Made of double charge porcelain stoneware, each piece is installed on 27,5x25,7 cm sheets. The chromatic range results to be deep and intense, thanks to the matt surface which gives a natural character to the product. Even in this case the element is available in two versions, through the usage of matching or with contrasting grout, for a stronger vibration. Thanks to Triangle, the shape of the rhombus is interpreted in its three-dimensional shape, in order to create games of lights and darkness on the surface: the elements, realized in Large and Small versions, seem to arise from the floor and to carry on the wall covering.

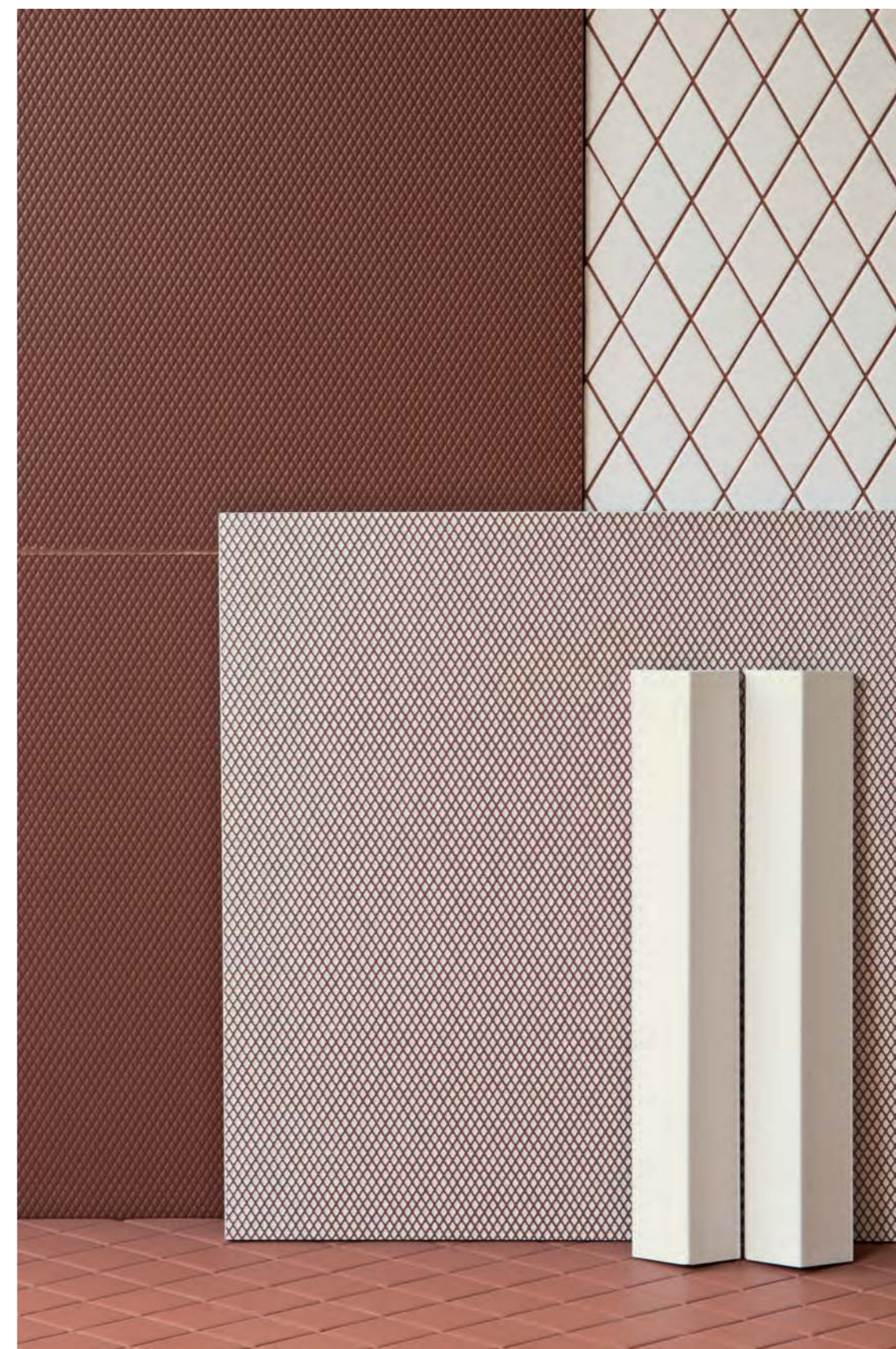

CARRÉ

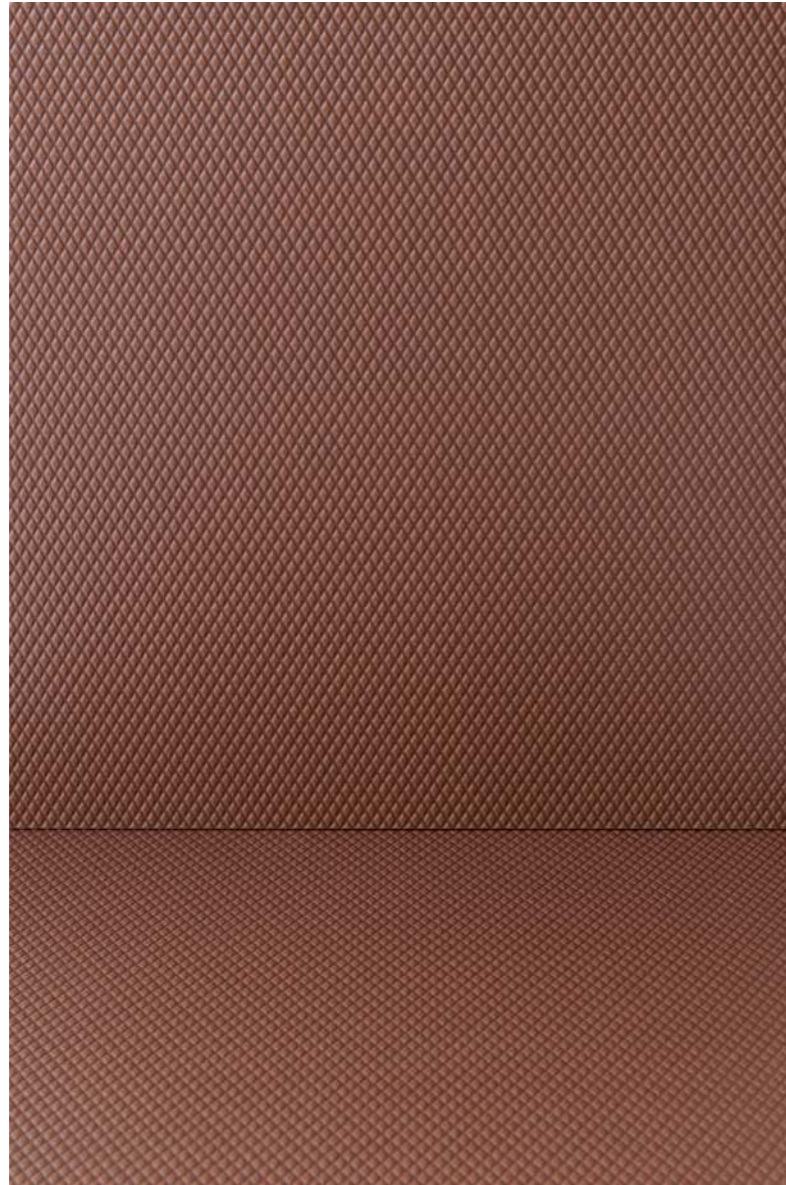

CARRÉ / Uni Red



CARRÉ / Light Green - Uni Green



CARRÉ / Light Blue



CARRÉ /
Uni Grey + Losange Grey
Light Green + Losange Green
Uni Red + Losange White

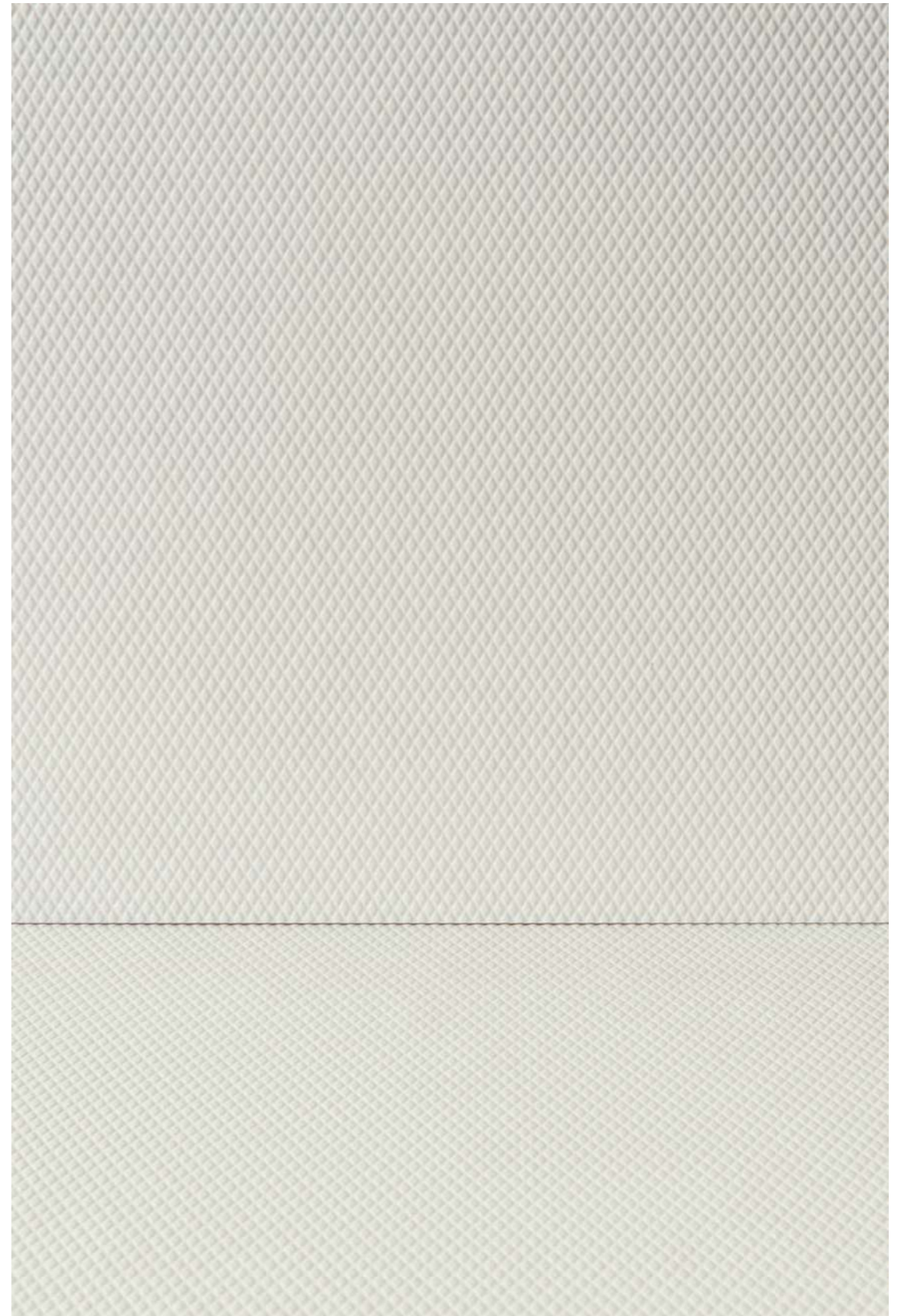

CARRÉ / Uni White

LOSANGE



LOSANGE / White - Blue



LOSANGE /
White + Triangle Large Red
Red + Triangle Large Grey
Blue + Triangle Large Blue

TRIANGLE



TRIANGLE / Large White + Losange White



TRIANGLE / Small White + Large Red



TRIANGLE / Small Green + Carré Light Green



TRIANGLE / Large Grey + Carré Light Grey

ROMBINI

design Ronan & Erwan Bouroullec - 2015

production industrial + artisanal

material

Carré: gres porcellanato smaltato ad impasto omogeneo - glazed homogeneous porcelain stoneware

Losange: gres porcellanato in doppio caricamento - double charge porcelain

Triangle: ceramica smaltata - glazed ceramic

features

Carré: lastre squadrate e rettificate ognuna esattamente uguale all'altra

squared and rectified slabs each one exactly the same as the others

thickness Carré 10 mm - Triangle 22 mm - Losange 4,7 mm

*misure nominali - nominal sizes

ROMBINI / sizes and colours

CARRÉ

*40-40 (16"-16")



CARRÉ UNI / White

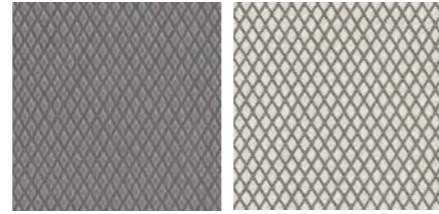

CARRÉ UNI / Grey CARRÉ LIGHT / Grey

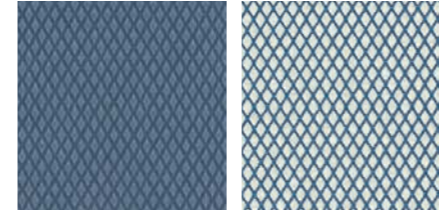

CARRÉ UNI / Blue CARRÉ LIGHT / Blue

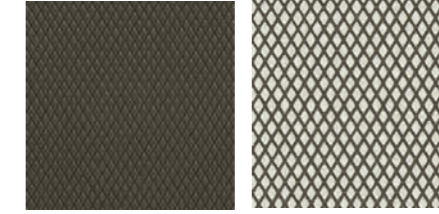

CARRÉ UNI / Green CARRÉ LIGHT / Green

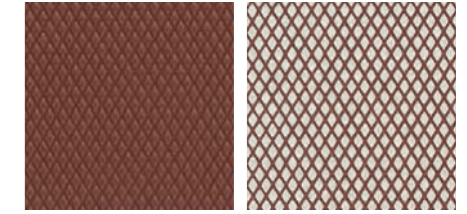

CARRÉ UNI / Red CARRÉ LIGHT / Red

BATTISCOPA CARRÉ UNI / *3,8-40 (2"-16")



CARRÉ UNI / White



CARRÉ UNI / Grey



CARRÉ UNI / Blue



CARRÉ UNI / Green



CARRÉ UNI / Red

LOSANGE

*27,5-25,7 (11"-10")



LOSANGE / White

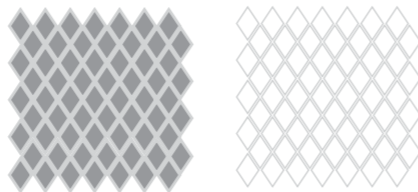

LOSANGE / Grey LOSANGE / White

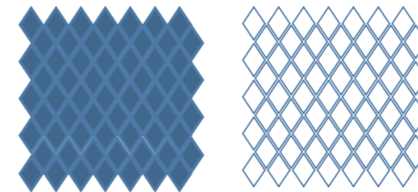

LOSANGE / Blue LOSANGE / White

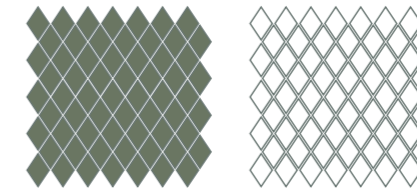

LOSANGE / Green LOSANGE / White

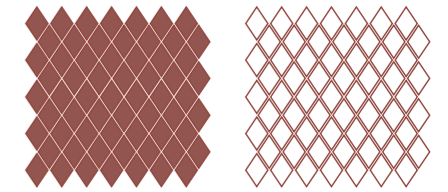

LOSANGE / Red LOSANGE / White

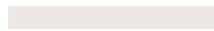

STUCCO / Calce 01



STUCCO / Cemento 06



STUCCO / Dark Blue



STUCCO / Piombo



STUCCO / Red

TRIANGLE SMALL

5 pcs *31,5-3,5-2,2 (12"-1"-1")
on net *18,6-31,5-2,2 (7"-12"-1")

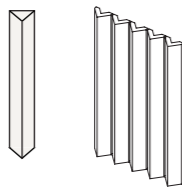

TRIANGLE SMALL / White

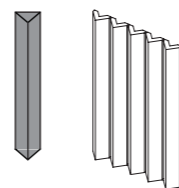

TRIANGLE SMALL / Grey

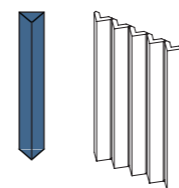

TRIANGLE SMALL / Blue

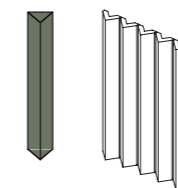

TRIANGLE SMALL / Green

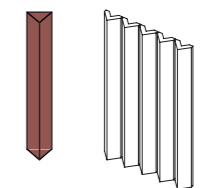

TRIANGLE SMALL / Red

TRIANGLE LARGE

3 pcs *31,5-6-2,2 (12"-2"-1")
on net *18,6-31,5-2,2 (7"-12"-1")

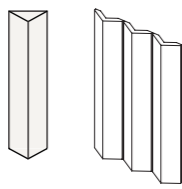

TRIANGLE LARGE / White

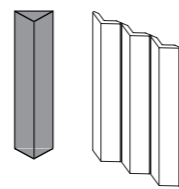

TRIANGLE LARGE / Grey

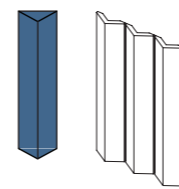

TRIANGLE LARGE / Blue

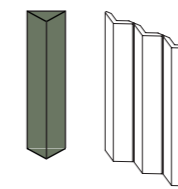

TRIANGLE LARGE / Green

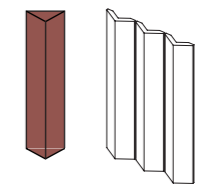

TRIANGLE LARGE / Red

ROMBINI / complementary pieces

RACCORDO LOSANGE - TRIANGLE SMALL / *3,5-4,8 (2"·2")

Tessere di mosaico di dimensioni particolari da utilizzare come raccordo Losange - Triangle Small. Vendita a pezzo sciolto. Disponibile in tutti i colori della collezione.

Chips of mosaics with particular sizes to be used as a connector between Losange and Triangle Small. Product sold in bulk. Available in all colours of the collection.

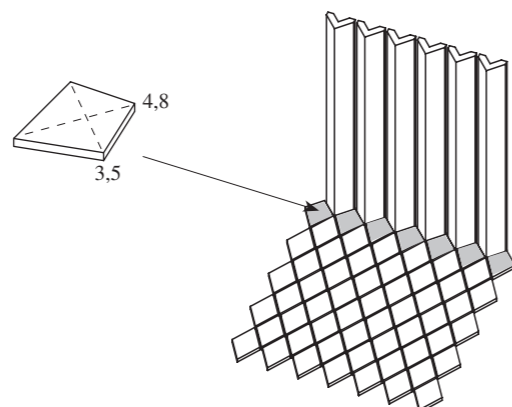

TERMINAL SMALL / *25,7· H 1,5· 2,8 (10"· H 1"·2")

TERMINAL LARGE / *24,6· H 1,5· 2,8 (10"· H 1"·2")

Terminale di chiusura disponibile in tutti i colori della collezione. 1 pezzo di Terminal Small è modulare con 7 pz di Triangle Small. 1 pezzo di Terminal Large è modulare con 4 pz di Triangle Large.

Closing piece available in all colours of the collection.

1 piece of Terminal Small is modular with 7 pieces of Triangle Small. 1 piece of Terminal Large is modular with 4 pieces of Triangle Large.

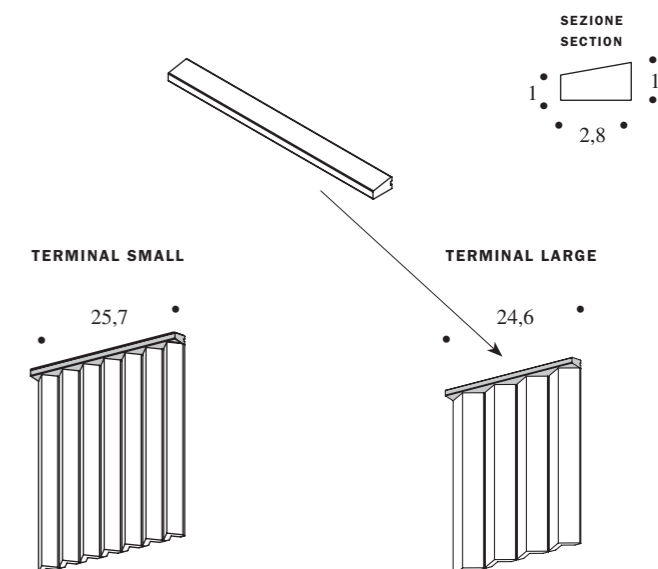

LISTELLO DI CHIUSURA / *8- 31,5- 0,6 (3"· 12"·1")

Listello con un bordo smaltato da utilizzare come chiusura a parete o come raccordo Losange - Triangle (Small o Large) negli angoli. Disponibile in tutti i colori della collezione.

Listello with a glazed edge to be used in the corner as wall closure or as a connector between Triangle (Small and Large) and Losange. Available in all colours of the collection.

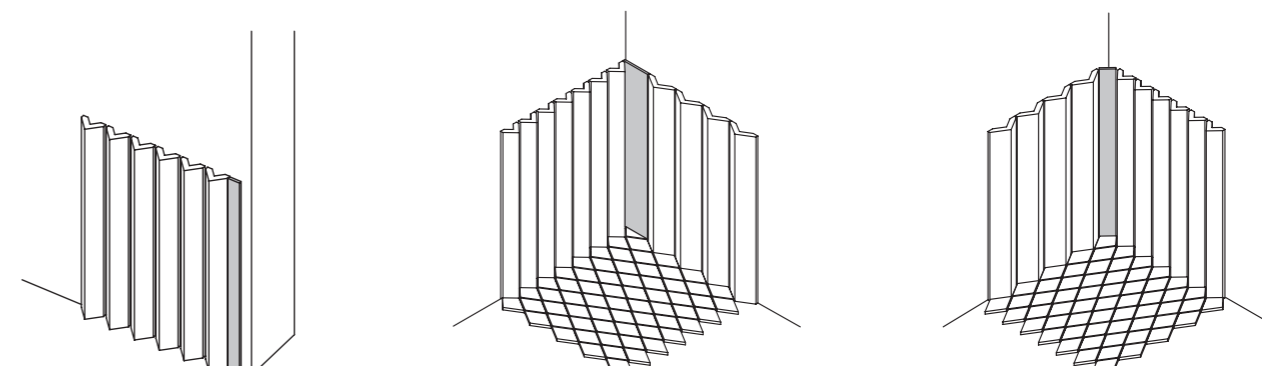
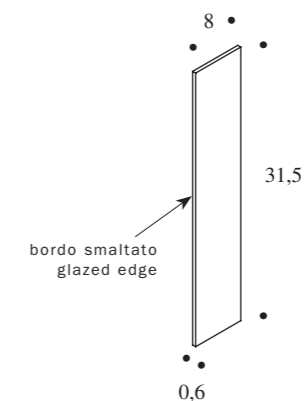

ROMBINI / technical features

BI GROUP

norma standard	caratteristiche features	valore prescritto value required	ROMBINI CARRÉ
ISO 10545/3	assorbimento d'acqua water absorption	<0,5%	<0,5%
ASTM C373		<0,5%	<0,5%
ISO 10545/9	resistenza agli sbalzi termici resistance to thermal shock	nessuna alterazione visibile no visible alteration	resiste resistant
ASTM C484		no samples must show visible defects	unaffected
ISO 10545/12	resistenza al gelo frost resistance	nessuna alterazione visibile no visible alteration	resiste resistant
ASTM C1026		unaffected	unaffected
ISO 10545/13	resistenza agli attacchi chimici resistance to chemical attacks	nessuna alterazione visibile no visible alteration	GA-GLA
ASTM C650			GA-GLA
ISO 10545/4	sfuerzo di rottura (N) breaking strength (N)	Sp \geq 7,5 min 1.300	resiste resistant
DIN 51130 - 04		valori medi 6° ÷ 10° 10° ÷ 19° 19° ÷ 27° 27° ÷ 35° > 35°	R9 R10 R11 R12 R13
ISO 10545/14	resistenza alle macchie stains resistance	CLASSE 3 MIN. MINIMUM 3	5
ISO 10545/7	resistenza all'abrasione superficiale resistance to superficial abrasion		PEI 4
EN 101	durezza superficiale (scala mohs) surface hardness (scala mohs)	> 5	6

BI GROUP

norma standard	caratteristiche features	valore prescritto value required	ROMBINI LOSANGE
ISO 10545/3	assorbimento d'acqua water absorption	<0,5%	0,4%
ASTM C373		<0,5%	0,4%
ISO 10545/9	resistenza agli sbalzi termici resistance to thermal shock	nessuna alterazione visibile no visible alteration	resiste resistant
ASTM C484		no samples must show visible defects	unaffected
ISO 10545/12	resistenza al gelo frost resistance	nessuna alterazione visibile no visible alteration	resiste resistant
ASTM C1026		unaffected	unaffected
ISO 10545/13	resistenza agli attacchi chimici resistance to chemical attacks	nessuna alterazione visibile no visible alteration	resiste resistant
ASTM C650			unaffected
ISO 10545/4	sfuerzo di rottura (N) breaking strength (N)	N/mm2 > 35	76,4
DIN 51130 - 04		valori medi 6° ÷ 10° 10° ÷ 19° 19° ÷ 27° 27° ÷ 35° > 35°	R9 R10 R11 R12 R13
ISO 10545/14	resistenza alle macchie stains resistance	CLASSE 3 MIN. MINIMUM 3	5

ROMBINI / technical features

BIla GROUP

norma standard	caratteristiche features	valore prescritto value required	ROMBINI TRIANGLE
ISO 10545/3	assorbimento d'acqua water absorption	3 \leq X \leq 6%	3,8%
ASTM C373		3 \leq X \leq 6%	3,8%
ISO 10545/9	resistenza agli sbalzi termici resistance to thermal shock	nessuna alterazione visibile no visible alteration	resiste resistant
ASTM C484		no samples must show visible defects	unaffected
ISO 10545/14	resistenza alle macchie stains resistance	CLASSE 3 MIN. MINIMUM 3	5

ROMBINI / packing

formato size	pz-mq pcs-sqm	pz-scat. pcs-box	mq-scat. sqm-box	scat.-pal. box-pal.	kg-scat. kg-box	kg-pal. kg-pal.	mq-pal sqms-pal
carré 40-40	6,25	8	1,28	48	26	1248	61,44
battiscopa 3,8-40	-	10	4 ml	-	3,25	-	-
losange 27,5-25,7	14,00	7	0,50	90	5	450	45
raccordo losange - triangle small 3,5-4,8	-	-	-	-	-	-	-
triangle small su rete/on net 18,6-31,5	17	9	0,53	72	11,00	792	38,16
triangle large su rete/on net 18,6-31,5	17	9	0,53	72	10,00	720	38,16
terminal small	-	10	2,57 ml	-	3,25	-	-
terminal large	-	10	2,46 ml	-	3,25	-	-
listello di chiusura 8-31,5-0,6	-	-	-	-	-	-	-

credits

photos Studio Bouroullec

graphic project Simona Bernardi

text Mutina

Printed and bound in Italy, September 2015.

All the rights are reserved. Not any part of this work can be reproduced in any way without the preventive written authorization by Mutina.

All work is copyrighted © to their respective owners.

CERAMICHE MUTINA SPA

Via Ghiarola Nuova 16

41042 Fiorano MO

Italia

+ 39 0536 812800 T

+ 39 0536 812808 F

mutina.it

