

Hives

Design by
Konstantin Grcic

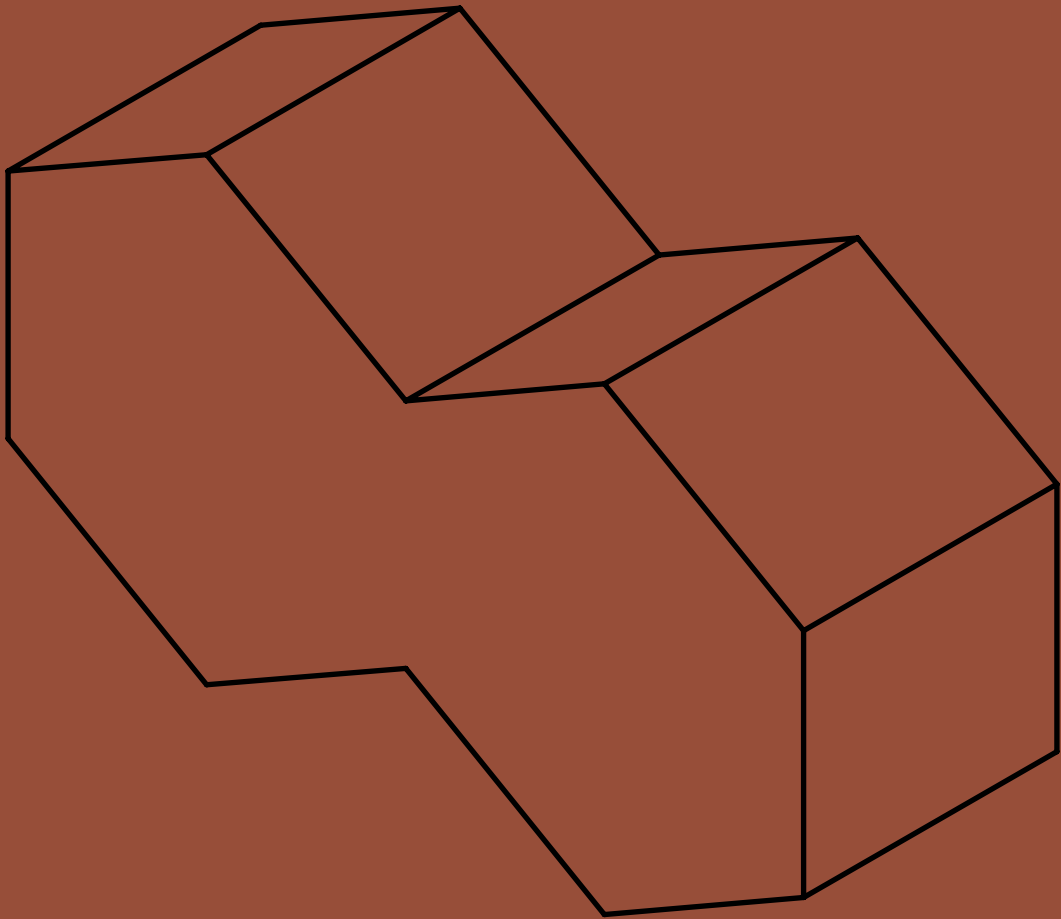

Mutina

Hives	6
About a brick	24
Technical Features	26



L'esagono è interessante perché si tratta di una forma sia geometrica che organica. Ha un aspetto tecnico, ma è stato inventato dalla natura.

The hexagon is interesting, because it is both geometric and organic. It looks technical, but it was invented by nature.

Konstantin Grcic



Hives

Hives si compone di un unico modulo: un mattone di forma esagonale, realizzato in terracotta – materiale antico di cui conserva colore, texture e proprietà – secondo la tecnica artigianale della trafilatura. Nel progettare questo modulo, Konstantin Grcic si è ispirato agli alveari, le costruzioni più efficienti presenti in natura, nonché potenzialmente espandibili fino all'infinito. Il risultato è un elemento 3D funzionale e dalla geometria organica, disponibile in un singolo formato che misura 13x22,5x7 cm. Hives può essere utilizzato sia in interno che in esterno, purché coperto, posato in diversi modi per creare soluzioni dall'aspetto contemporaneo e innovativo. I mattoni possono essere installati sia dal lato verticale, per dare vita a divisori, che in orizzontale. Posizionati in questo modo, allineati o sfalsati, consentono di ottenere pareti curve per la costruzione di elementi architettonici e pezzi d'arredamento, come colonne, banconi o piedi di tavoli.

Hives features one single module: an hexagonal brick handcrafted in extruded terracotta, an ancient material of which it preserves colour, texture and properties. Konstantin Grcic drew inspiration for this element from beehives, the most efficient structures found in nature, almost infinitely expandable. The result is a functional 3D element with an organically geometry, available in the size 13x22,5x7 cm. Hives can be used both indoor and outdoor, so long as under cover, placing the elements in different positions in order to create contemporary and innovative aesthetic solutions. The bricks can be installed both in upright orientation, to build dividing walls, and in flat orientation. In this way, they can be placed laid flush with each other or in a staggered arrangement, giving birth to curved walls for the construction of architectural elements and furniture, such as columns, counters and table legs.

Laying scheme B

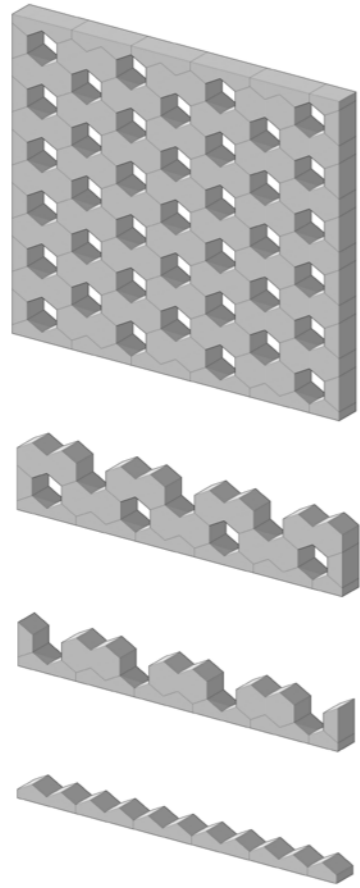

Hives può essere utilizzato per la costruzione di pareti divisorie caratterizzate da un pattern che gioca con l'accostamento di pieni e vuoti.

Hives can be used to build partition walls characterised by a pattern that plays with the juxtaposition of solids and voids.

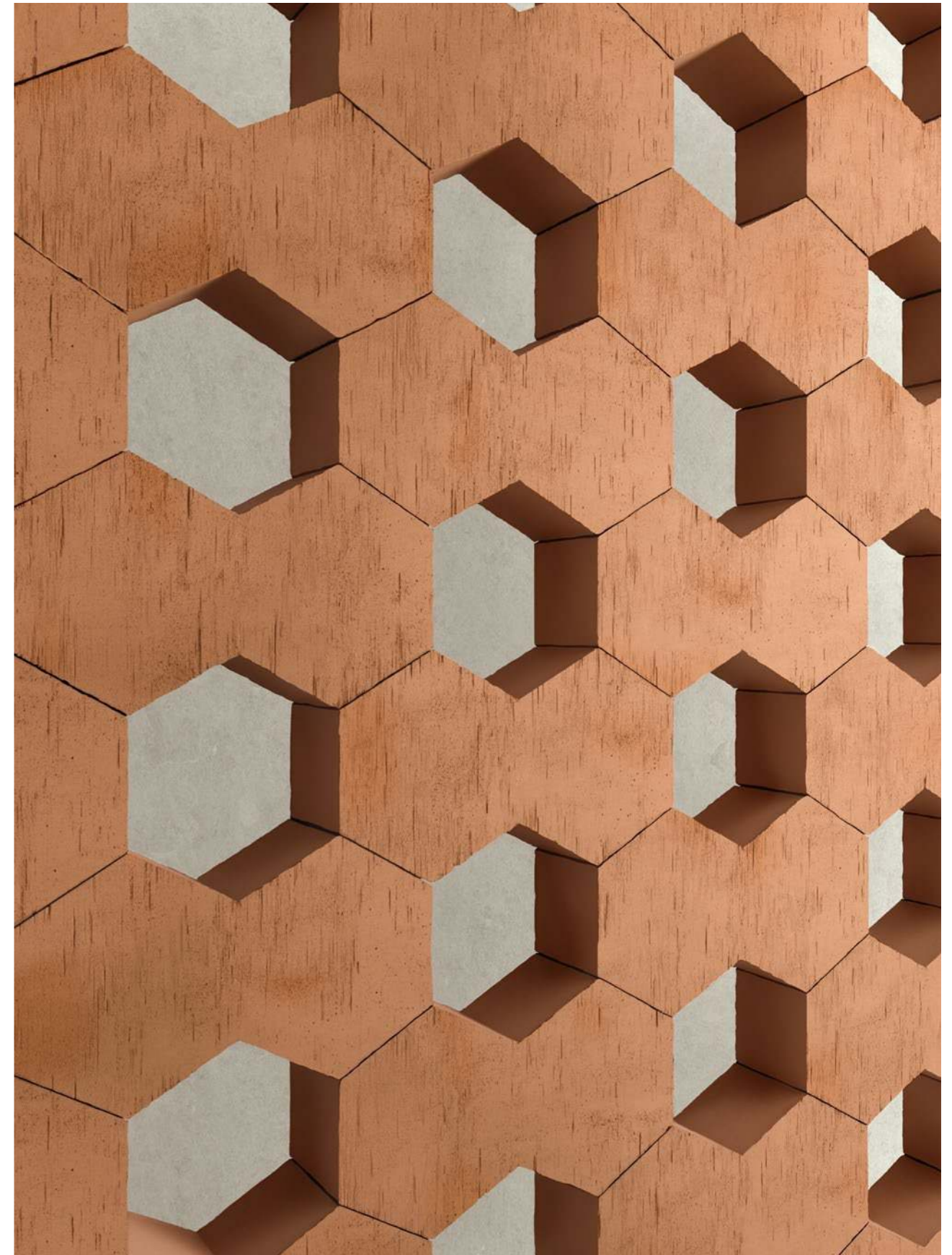

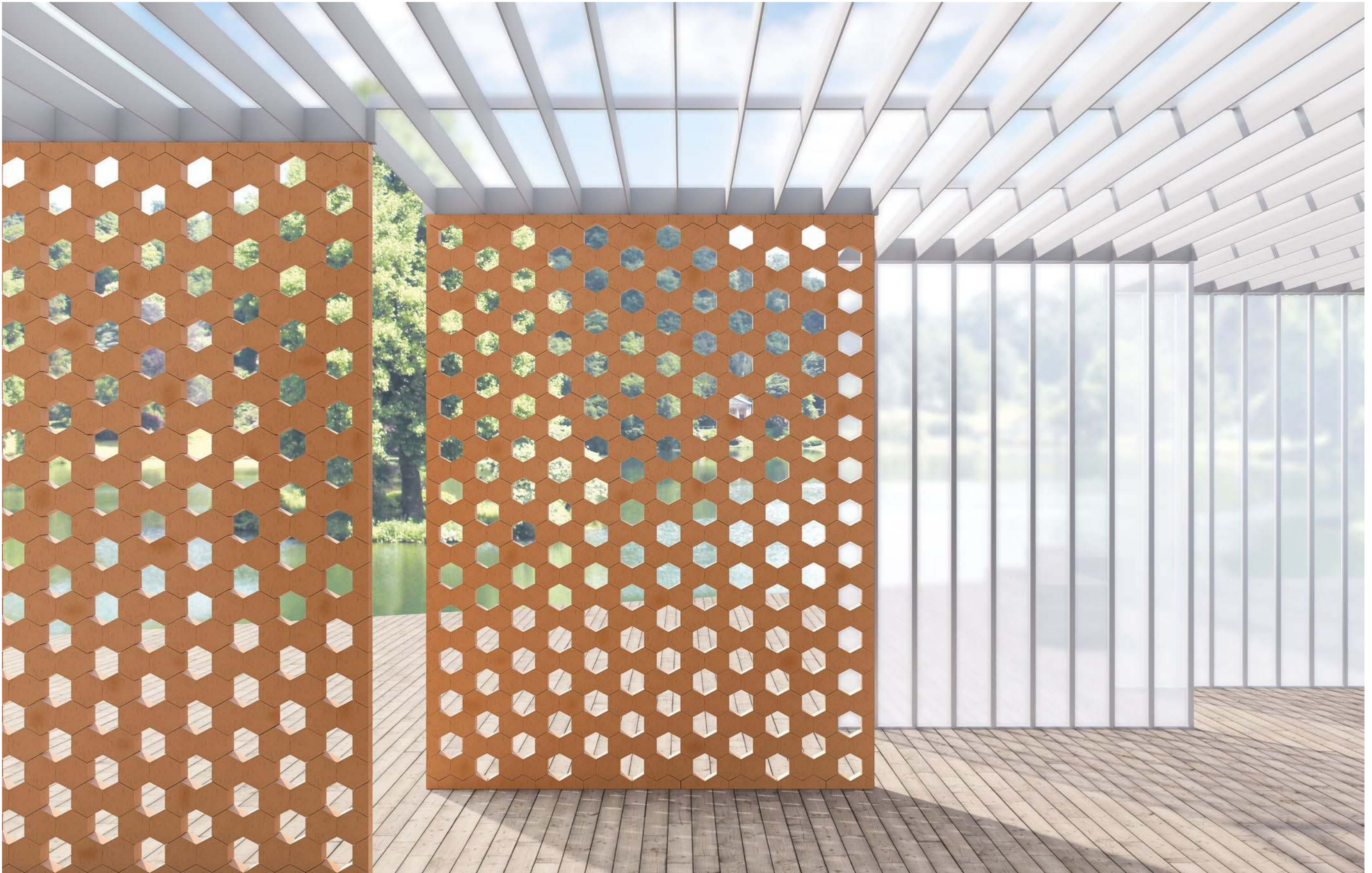

Laying scheme H

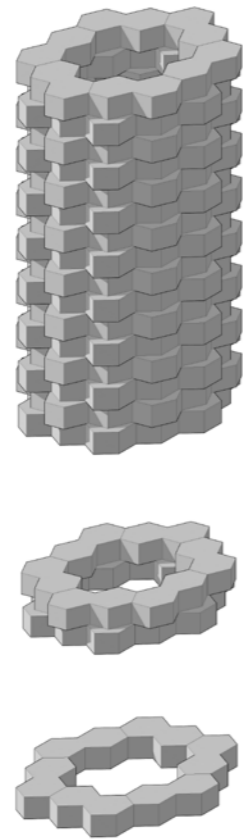

Gli elementi di Hives possono essere posizionati allineati o sfalsati, in questo modo gli angoli permettono di creare delle colonne dall'aspetto moderno e innovativo.

Hives elements can be placed laid flush with each other or in a staggered arrangement. The angles of the hexagon make it possible to create modern and innovative columns.





Laying scheme C

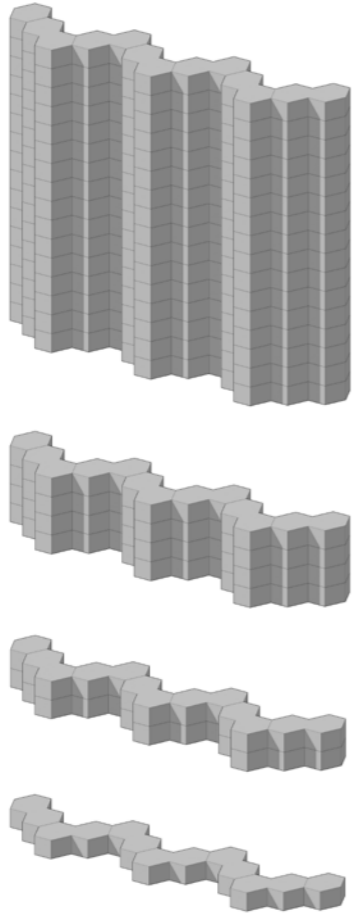

Utilizzando Hives in orizzontale si possono ottenere pareti curve dall'aspetto fortemente decorativo.

Placing Hives elements in flat orientation allows to obtain highly decorative curved walls.





Laying scheme E

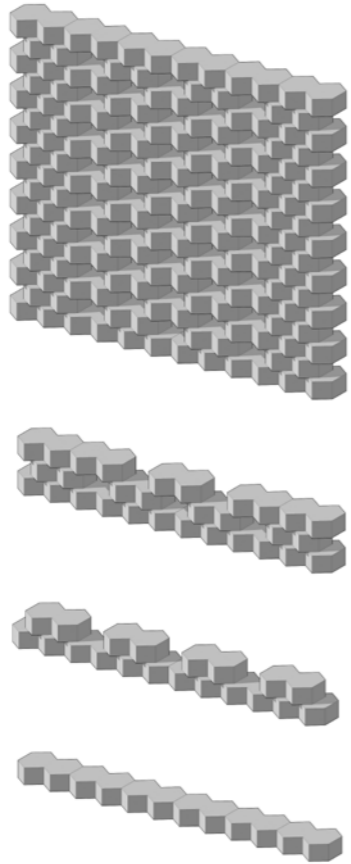

Hives può essere utilizzato sia in interno che in esterno, purché al coperto.

Hives can be used both indoor and outdoor, so long as under cover.





About a brick

A talk with Konstantin Grcic

Hives è il tuo primo esperimento con un elemento 3D per Mutina. In che cosa consiste?

I mattoni sono uno dei materiali da costruzione più antichi, risalenti circa al 4000 a.C. È incredibilmente affascinante pensare che siano utilizzati ancora oggi ed ero emozionato di poterne progettare uno. L'aspetto della tridimensionalità rende i mattoni piuttosto diversi dalle piastrelle. Pur essendo entrambi dei moduli, una piastrella ha bisogno di una struttura di supporto, mentre un mattone è di per sé una struttura.

Perché hai scelto la forma esagonale?

Mi sarebbe piaciuto molto progettare un mattone rettangolare, ma è già stato fatto (sorride). L'esagono è interessante perché si tratta di una forma sia geometrica che organica. Ha un aspetto tecnico, ma è stato inventato dalla natura. Gli alveari sono costituiti da tante celle esagonali – è la geometria migliore per ottenere una struttura ampliabile quasi all'infinito.

È possibile utilizzare Hives in diversi modi?

Hives si può orientare in due modi diversi – dal lato verticale e da quello orizzontale. Nel primo caso l'esagono diventa il motivo grafico della parete, permettendo di ottenere delle piccole aperture (esagonali). Nel secondo caso, invece, le geometrie determinano la struttura e la forma del muro. Gli elementi di Hives possono essere stratificati e dare vita a numerosi pattern, chiamati anche legami. Possono anche essere posizionati allineati o sfalsati, in questo modo gli angoli permettono di costruire pareti curve e colonne.

Che tipo di effetto volevi ottenere utilizzando unicamente l'argilla?

L'argilla è il più antico materiale ceramico conosciuto. Ha una buona struttura, proprietà acustiche e termiche... ed è bello da guardare. Mi piace la matericità dei mattoni grezzi. L'argilla rossa che utilizziamo per Hives conferisce una sfumatura calda e piacevole.

Hives is your first experiment with a 3D element for Mutina. What is it all about?

Fired bricks are amongst the most ancient building materials dating back to about 4000 b.C. It is incredibly fascinating to think that we are still using bricks today and I was thrilled about the opportunity to design one. The 3-dimensional aspect of bricks is quite different to tiles. Both elements are modules, however, a tile needs a support structure, whereas the brick is the structure itself.

Why did you choose the hexagonal shape?

I would have loved to design a rectangular brick, but that has already been done (smiles). The hexagon is interesting, because it is both geometric and organic. It looks technical, but it was invented by nature. Beehives are modelled from hexagons – it is the most efficient geometry to achieve an almost infinitely expandable structure.

Are there different ways in which you can use Hives?

You can use Hives in two different orientations – upright and flat. In the upright orientation, the hexagon creates the pattern of the wall. This application makes it possible to include small (hexagonal) openings in the wall. Using the brick in a flat orientation means that the hexagonal shape determines the structure and shape of the wall. Hives can be laid in courses and numerous patterns, also referred to as bonds. The bricks can be laid flush with each other or in a staggered arrangement. The angles of the hexagon make it possible to build curved walls and columns.

What feeling did you want to achieve by using just clay?

Clay is the oldest known ceramic material. It has good structural, thermal and acoustic properties ... and it is beautiful to look at. I like the raw quality of a brick which is pure material. The red clay we are using for Hives adds a warm and pleasant colour.

Technical Features

General Information

collection	Hives
design	Konstantin Grcic, 2022
production	Artisanal
material	Extruded terracotta
nominal sizes	13-22,5-7 cm (5"-9"-3")
specification	<ul style="list-style-type: none"> - Artisanal extruded partition elements, 7cm thick. Natural (natural finishing) - It is possible to install Hives both horizontally and vertically. - For aesthetic outcome it is possible to install Hives using our wooden profile. The profile is painted and suitable for outdoor use. A top profile with removable sides is provided for ceiling fixing. - This product is suitable for both residential and commercial areas, to be installed in walls with height of 4mt. These elements must in any case comply with the technical standards of construction regulation, applicable in the country where they are installed. - For the Italian national territory, in particular, they should comply with standard NTC 2018 DECRETO MIN 27/01. - As complementary pieces Mutina provide the Mutina sealant, EC 1 plus for VOC emissions. <p>For installation process see the installation video available on www.mutina.it for Celosia</p> <p>Hives is suitable for indoor and outdoor areas complying with UNI EN 772-22 marked "F1- moderate exposure".</p>
category	UNI 11128/2004

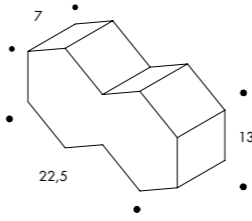
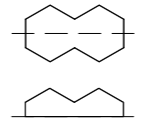
At the base of laying scheme A and B, place a piece obtained by cutting Hives bricks in half on the long side

colors



Natural

complementary pieces

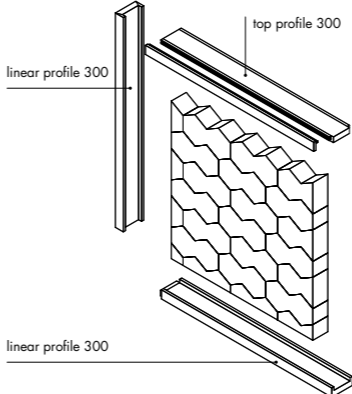

section

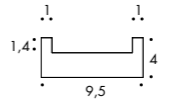

To make the installation of these items easier, a Mutina sealant is now available: an organic and eco-friendly sealing material, which is sold separately.

Laying and maintenance tips

use	Wall – indoor, outdoor.
installation	For installation process see the installation video available on www.mutina.it
cleaning at the end of installation	Avoid drippings during installation. If needed the excess can be removed after the product has dried, using a tool with a sharp edge.
calibers (real size)	22,5 x 13,1 x 7 cm with 1-3 mm tolerance (artisanal product)

Hives – laying scheme A

45 pcs / sqm

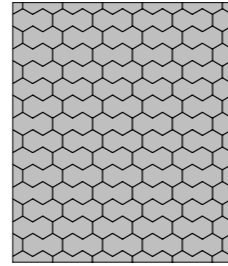

section

Overlap

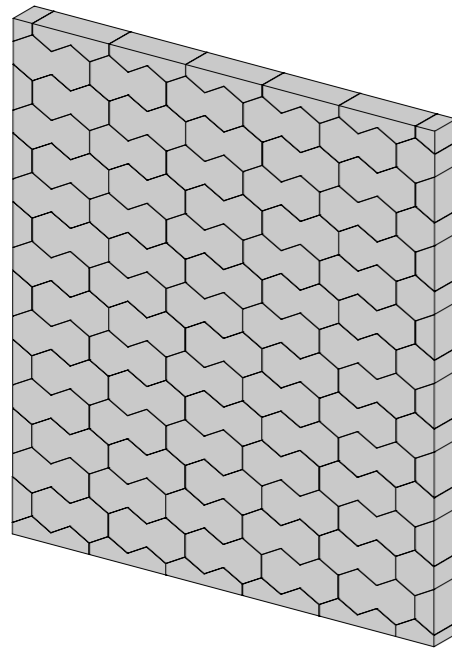

2nd row

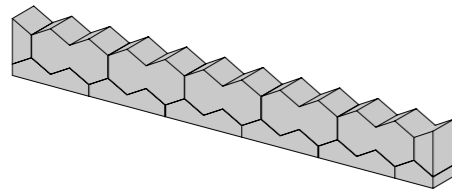

1st row

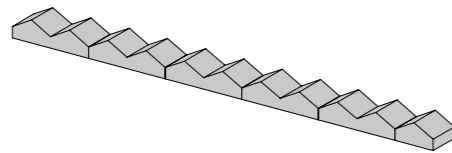

Hives – laying scheme B

30 pcs / sqm

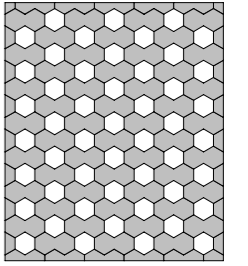

section

Overlap

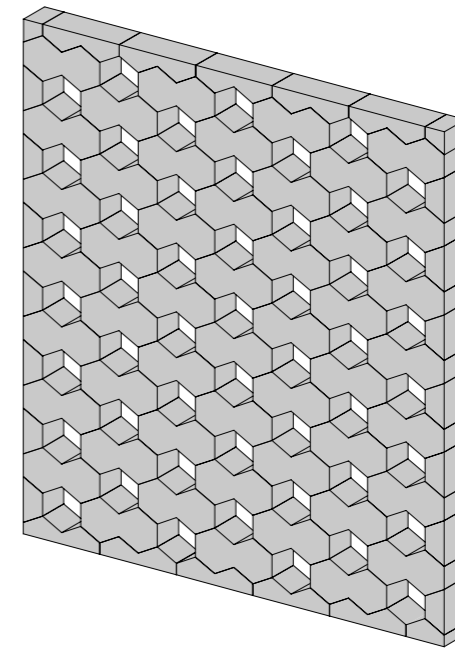

2nd row

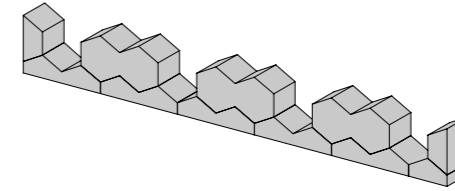

1st row

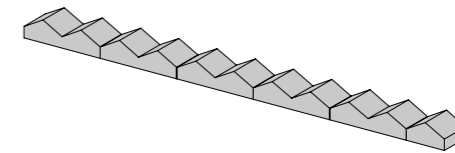

Hives – laying scheme C

61 pcs / sqm

Staggered installation only.

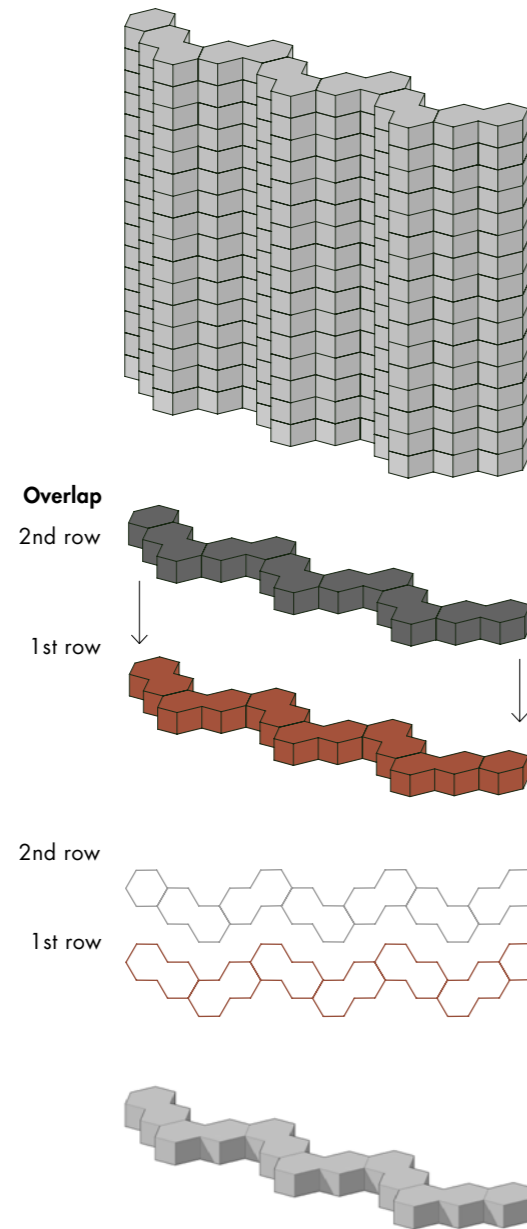

Hives – laying scheme D

186 pcs / sqm

Staggered installation only.

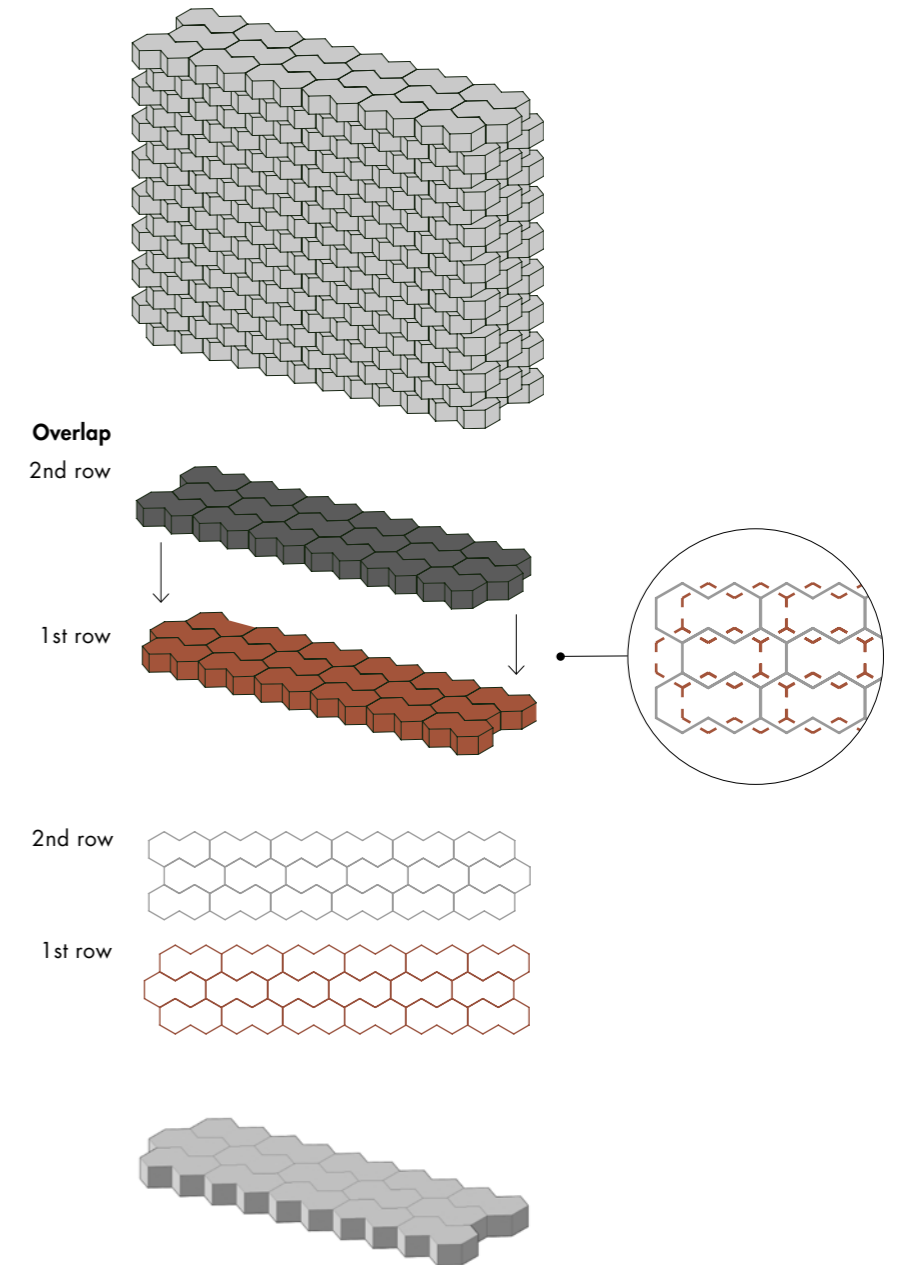

Hives – laying scheme E

61 pcs / sqm (side column)

46 pcs / sqm (central area)

Staggered installation only.

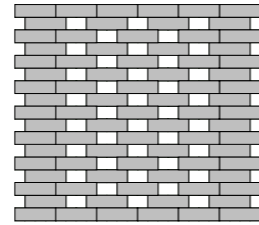

section

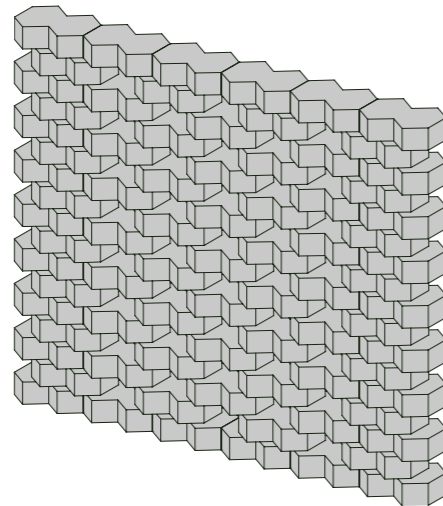

Overlap

2nd + 3rd row

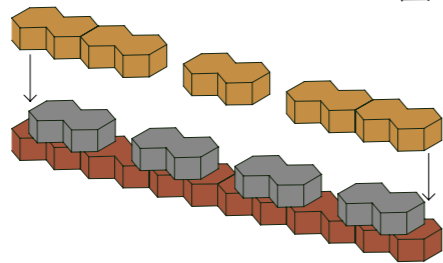

1st + 2nd row

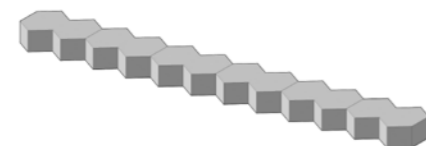
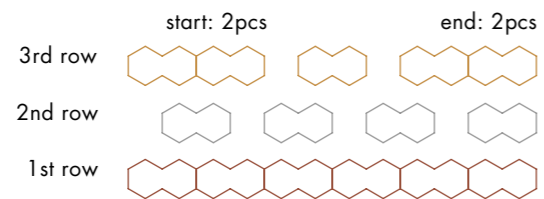
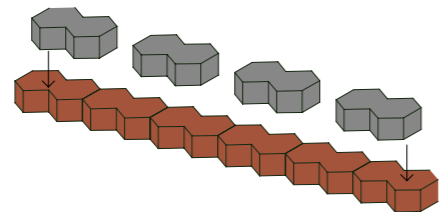

Hives – laying scheme F

61 pcs / sqm

Staggered installation only.

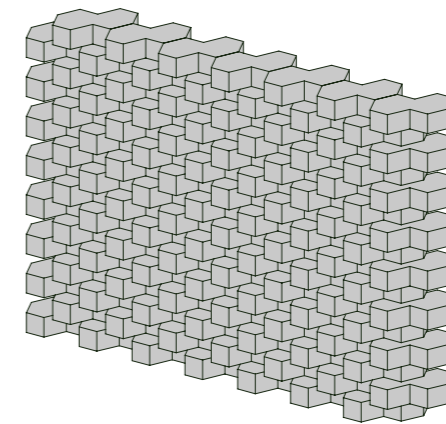

Overlap

2nd row

1st row

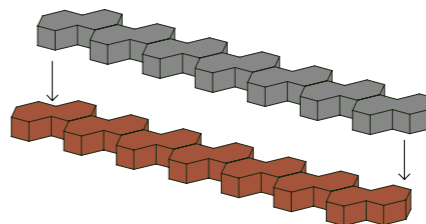

2nd row

1st row

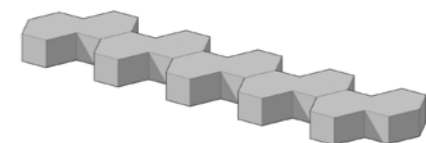
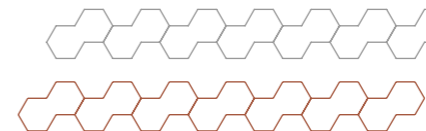

Hives – laying scheme G

84 pcs / 1m

Staggered installation only.

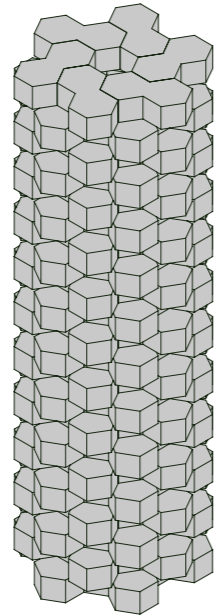

Overlap

2nd row

1st row

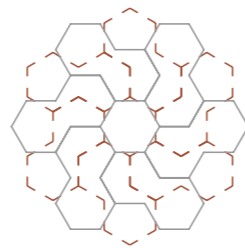
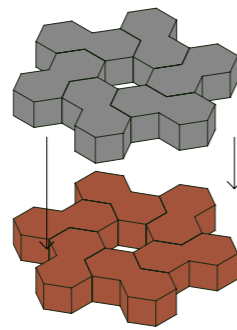

1st row

2nd row

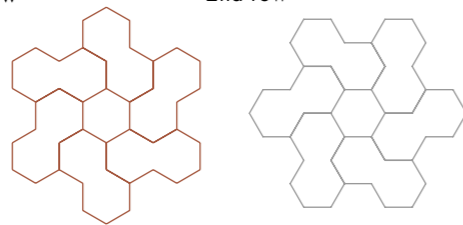

Hives – laying scheme H

84 pcs / 1m

Staggered installation only.

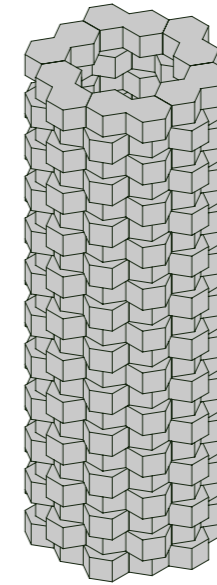

Overlap

2nd row

1st row

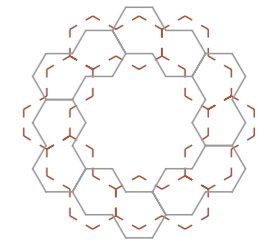
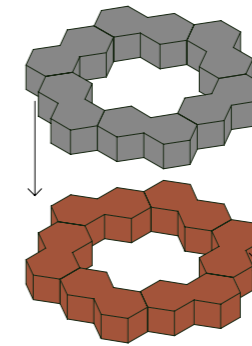

1st row

2nd row

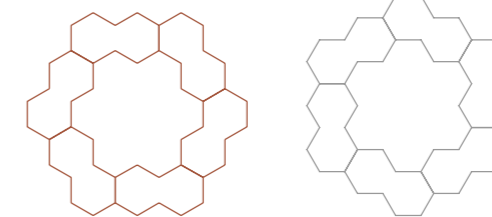

Technical features

STANDARD	FEATURES	VALUE REQUIRED	HIVES
UNI EN 772-16	dimensions	to declare	T2 – R2
UNI EN 772-21	water absorption	to declare	12,5%
UNI EN 772-5	content of active soluble salts	to declare	S2
UNI EN 772 - 22	freeze-thaw resistance	to declare	F1
D.M. 1401/2008	determination of horizontal variable loads	to declare	C2
LEED CERTIFICATION 4.1			10% recycled material
VOC Emission			available upon request
Declaration of Contents			available upon request
SDS			available upon request
BPD3			available upon request
HPD			available upon request

Packing

SIZE	SQM-PAL	KG-PAL	PCS-PAL	PC-SQM	KG-PC
13-22,5-7,5 cm	2,16	287,04	96	see laying scheme	2,99

Konstantin Grcic



Artista e designer di origini tedesche, Konstantin Grcic è entrato a far parte del team Mutina nel 2015, con la collezione Numi, a cui sono seguite DIN nel 2021 e Hives nel 2022. Dopo gli studi Design al Royal College of Art di Londra, Konstantin Grcic ha aperto il proprio studio di design a Monaco di Baviera nel 1991, dove ha sviluppato mobili, prodotti e illuminazione per alcune delle più importanti aziende di design al mondo (Authentics, BD Ediciones, ClassiCon, Flos, Flötotto, Magis, Maharam, Muji, Nespresso, Plank, Serafino Zani e Vitra). Molti dei suoi prodotti hanno ricevuto premi internazionali, come il prestigioso Compasso d'Oro per la sua lampada Mayday (Flos) nel 2001 e la sedia Myto (Plank) nel 2011, oltre a far parte delle collezioni permanenti dei più importanti musei di design (MoMA – New York, Centre Georges Pompidou – Parigi). La Royal Society for the Arts ha nominato Konstantin Grcic Royal Designer for Industry nel 2009, mentre Design Miami gli ha conferito il premio Designer of the Year per il 2010. Una monografia completa del suo lavoro è stata pubblicata da Phaidon Press, Londra (2005).

German artist and designer, Konstantin Grcic joined the Mutina team in 2015, with the Numi collection, followed by DIN in 2021 and Hives in 2022. After studying designed at the Royal College of Art in London, Konstantin Grcic opened his own studio in Munich in 1991, where he developed furniture, products and lighting for some the world's leading design companies (Authentics, BD Ediciones, ClassiCon, Flos, Flötotto, Magis, Maharam, Muji, Nespresso, Plank, Serafino Zani and Vitra). Many of his products received international design awards, such as the prestigious Compasso d'Oro for his Mayday lamp (Flos) in 2001 and the Muto chair (Plank) in 2011, furthermore they are part of the permanent collections of the most important design museums (MoMA – New York, Centre Georges Pompidou – Paris). The Royal Society for the Arts appointed Konstantin Grcic Royal Designer for Industry in 2009, while Design Miami awarded him Designer of the Year in 2010. A comprehensive monograph of his work was published by Phaidon Press, London (2005).

CREDITS

Art Direction: Alla Carta Studio
Graphic design: Sara Barberis, Matteo Pastorio
Text: Konstantin Grcic & Mutina
Images: Officine Mimesi (p.9–23),
Modofotografia (p.4, 5)
Illustration: Damien Florébert Cuypers (p.31)

January 2022 – 2nd edition

All the rights are reserved.
Not any part of this work can be reproduced
in any way without the preventive written
authorization by Mutina. All work is
copyrighted © to their respective owners.

To discover more about Mutina
collections visit mutina.it

Ceramiche Mutina Spa
Via del Crociale 25
41042 Fiorano Modenese, Italia
T +39 0536812800
F +39 0536812808
info@mutina.it
www.mutina.it

© Mutina 2022

