

WATERFALL

MATERIA MUTEVOLE
VARIABLE MATERIAL



LEA

CERAMICHE

SUPERFICIE
AD EFFETTO
PIETRA.

Surface
with a stone
effect.



WATERFALL

4 COLORI

ivory flow
silver flow
gray flow
dark flow

4 COLORS

ivory flow
silver flow
gray flow
dark flow

3 FINITURE

lappata
naturale
grip

3 FINISHES

lappata
naturale
grip

5 FORMATI

90x90cm
60x120cm
45x90cm
60x60cm
30x60cm

5 SIZES

36"x36"
24"x48"
18"x36"
24"x24"
12"x24"

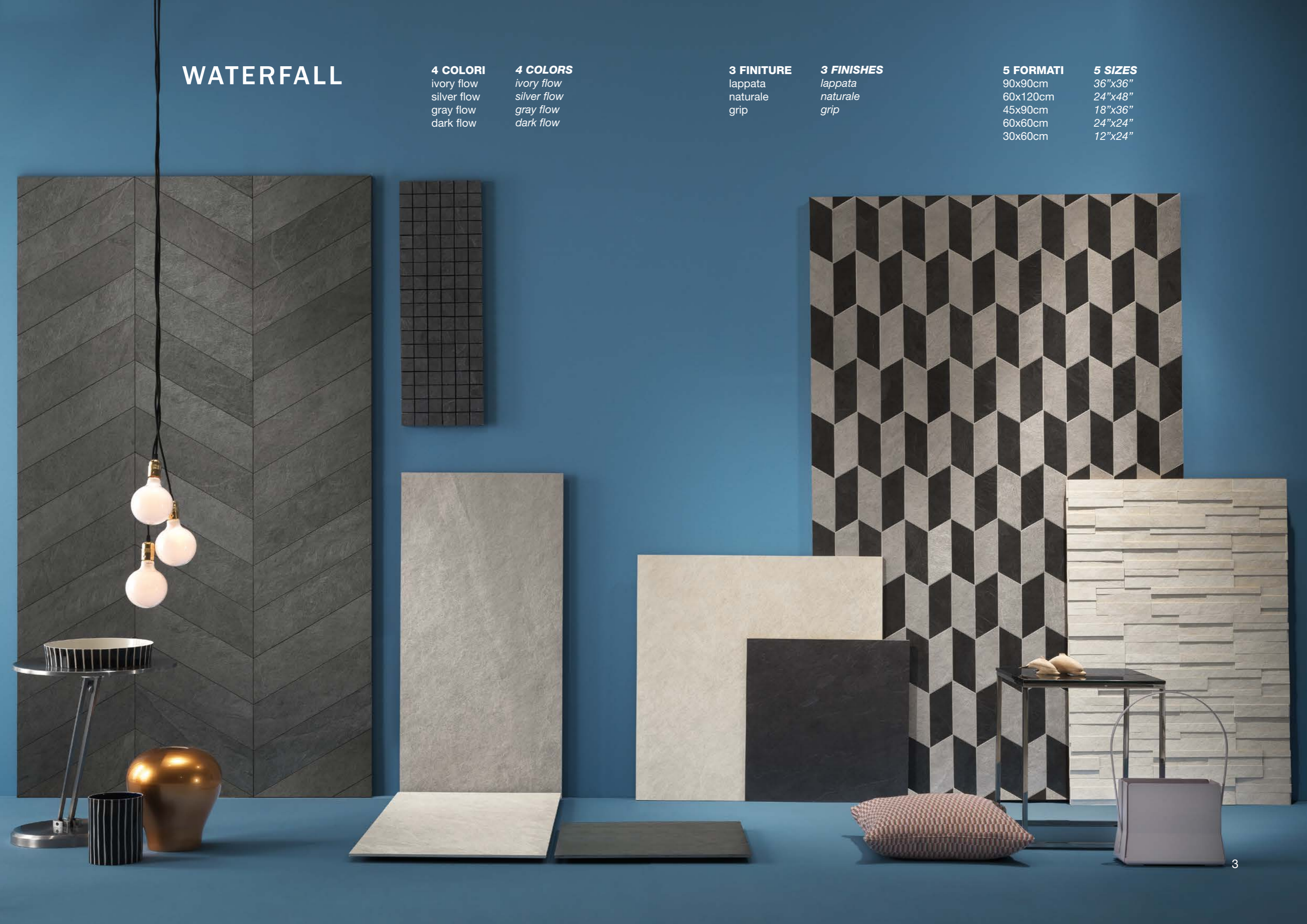

IVORY FLOW

90x90cm / 36"x36"
naturale rett.

Waterfall rilegge in modo realistico e fisico una pietra rocciosa e antica come l'ardesia. Ricreando sulla superficie del grès gli effetti cangianti tipici delle pietre rocciose sedimentarie, Waterfall registra texture, irregolarità e variazioni di colori, espressioni puntuali del trascorrere del tempo.

Waterfall realistically and physically represents slate, an ancient and natural stone. Recreating, on the stoneware surface the iridescence typical of sedimentary rocks, Waterfall has texture, irregularities, and variations in colour, typical expressions of the passage of time.

DARK FLOW

Parete / Wall
30x60cm / 12"x24"
lappata rett.
mosaico 36
30x30cm / 12"x12"
Pavimento / Floor
60x60cm / 24"x24"
lappata rett.



DARK FLOW

30x60cm / 12"x24"
lappata rett.



BASKET

**GRAMMA 66
DARK FLOW**

39,2x19,5cm / 15³/₈"x7⁵/₈"
naturale

**GRAMMA 16
SILVER FLOW**

19,5x9,7cm / 7⁵/₈"x3³/₄"
naturale

TWIST

**GRAMMA 66
GRAY FLOW**

39,2x19,5cm / 15³/₈"x7⁵/₈"
naturale





ARROW

GRAMMA 66
DARK FLOW
SILVER FLOW
39,2x19,5cm / 15³/₈"x7⁵/₈"
naturale

Le cromie, di base grigie, spaziano dalla tonalità più scura, il Dark Flow, a quella più chiara, Ivory Flow, richiamando il naturale processo di ossidazione della pietra, materia in continua trasformazione che cambia colore, forma e struttura, adattandosi all'evolversi dei fenomeni naturali.

The colours, in grey scale, vary from the darkest tone, Dark Flow, to the lightest, Ivory Flow, recalling the natural oxidation process of the stone, a material that is under continuous transformation, changing colour, shape, and structure, and adapting itself to the evolution of natural phenomenon.

CHEVRON

GRAMMA 72
GRAY FLOW
49,8x16,9cm / 19 1/2"x6 5/8"
naturale



IVORY FLOW

muretto 3D
30x60cm / 12"x24"
lappata rett.





IVORY FLOW

Parete / Wall
muretto 3D
30x60cm / 12"x24"
lappata rett.

Pavimento / Floor
90x90cm / 36"x36"
naturale rett.





La ricerca di Lea Ceramiche è andata oltre, adoperandosi non solo a restituire un materiale dalle qualità prestazionali indiscutibili, ma riuscendo a conferire una stratigrafia più complessa.

Con l'inclusione di altre tipologie di pietre come le quarziti brasiliane, si è arrivati ad una perfetta definizione estetica, un'armonizzazione grafica che conferisce alla materia eleganza e che interagisce col mutare della luce.

Lea Ceramiche's research went above and beyond, striving not only to create a material of indisputably high quality, but also successfully lending it a more complex stratigraphy.

With the inclusion of other types of stone, like Brazilian quartzite, the perfect aesthetic definition has been achieved, a graphic harmony that gives elegance to the material and that interacts with the changing light.

SILVER FLOW

muretto
30x60cm / 12"x24"
lappata rett.



SILVER FLOW

muretto
30x60cm / 12"x24"
lappata rett.

DARK FLOW

60x60cm / 24"x24"
lappata rett.

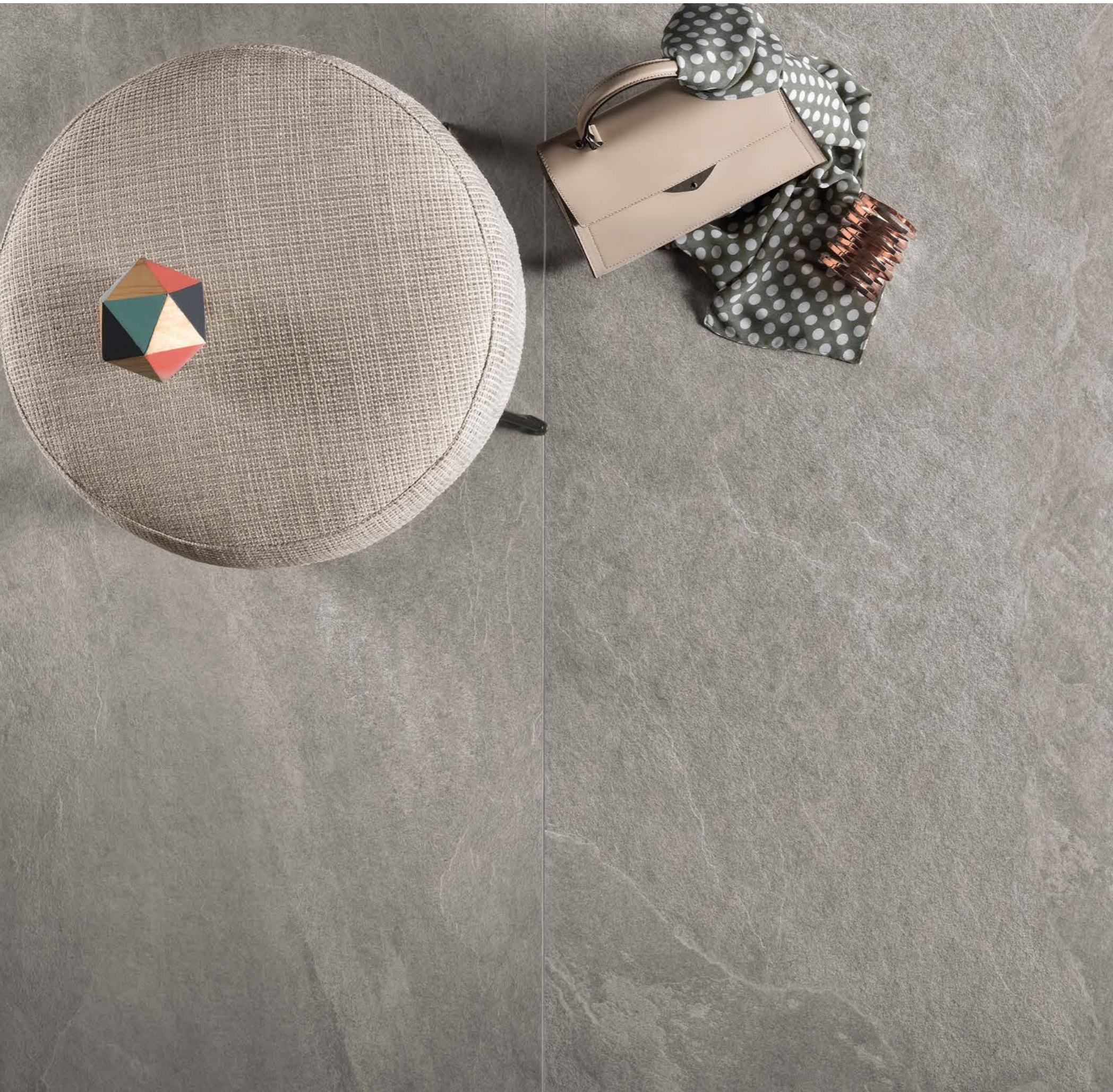

SILVER FLOW

60x120cm / 24"x48"
naturale rett.

IVORY FLOW

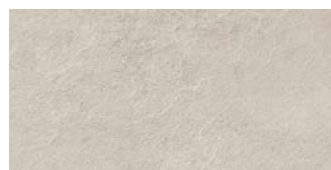

30x60cm / 12"x24"
lapp. rett. (spessore 10,5mm) LGVWFX2



60x60cm / 24"x24"
lapp. rett. (spessore 10,5mm) LGVWFX2
nat. rett. (spessore 10,5mm) LGVWFN2
*grip rett. (spessore 10,5mm) LGVWF20



45x90cm / 18"x36"
lapp. rett. (spessore 10,5mm) LGGWFX2
nat. rett. (spessore 10,5mm) LGGWFN2



90x90cm / 36"x36"
lapp. rett. (spessore 10,5mm) LG9WFX2
nat. rett. (spessore 10,5mm) LG9WF20



60x120cm / 24"x48"
lapp. rett. (spessore 10,5mm) LGXWFX2
nat. rett. (spessore 10,5mm) LGXWF20

SILVER FLOW

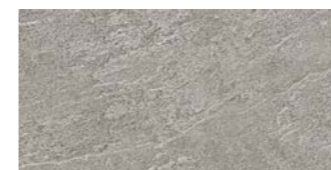

30x60cm / 12"x24"
lapp. rett. (spessore 10,5mm) LGVWFX3



60x60cm / 24"x24"
lapp. rett. (spessore 10,5mm) LGVWFX3
nat. rett. (spessore 10,5mm) LGVWFN3
*grip rett. (spessore 10,5mm) LGVWF30



45x90cm / 18"x36"
lapp. rett. (spessore 10,5mm) LGGWFX3
nat. rett. (spessore 10,5mm) LGGWFN3



90x90cm / 36"x36"
lapp. rett. (spessore 10,5mm) LG9WFX3
nat. rett. (spessore 10,5mm) LG9WF30



60x120cm / 24"x48"
lapp. rett. (spessore 10,5mm) LGXWFX3
nat. rett. (spessore 10,5mm) LGXWF30

*non trattato con antibatterico
without antimicrobial treatment
sans traitement antibacterien
nicht mit antibakterieller
Wirkung ausgestattet

GRAY FLOW



30x60cm / 12"x24"
lapp. rett. (spessore 10,5mm) LGVWFX1



60x60cm / 24"x24"
lapp. rett. (spessore 10,5mm) LGWWFX1
nat. rett. (spessore 10,5mm) LGWWFNI
*grip rett. (spessore 10,5mm) LGWWF10



45x90cm / 18"x36"
lapp. rett. (spessore 10,5mm) LGGWFX1
nat. rett. (spessore 10,5mm) LGGWFNI

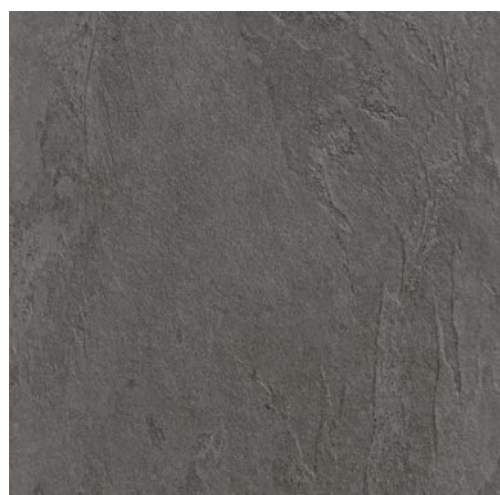

90x90cm / 36"x36"
lapp. rett. (spessore 10,5mm) LG9WFX1
nat. rett. (spessore 10,5mm) LG9WF10

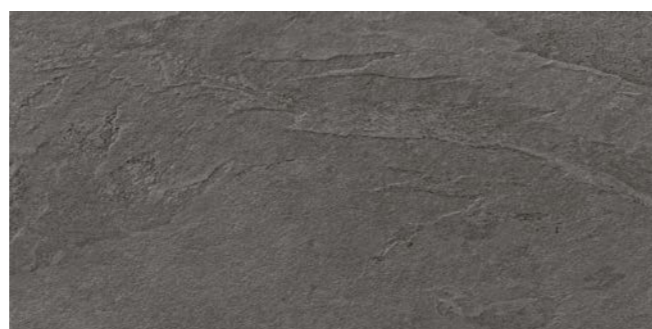

60x120cm / 24"x48"
lapp. rett. (spessore 10,5mm) LGXWFX1
nat. rett. (spessore 10,5mm) LGXWF10

DARK FLOW

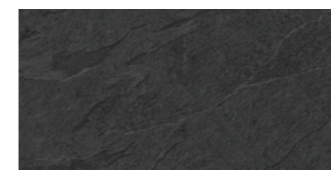

30x60cm / 12"x24"
lapp. rett. (spessore 10,5mm) LGVWFX0

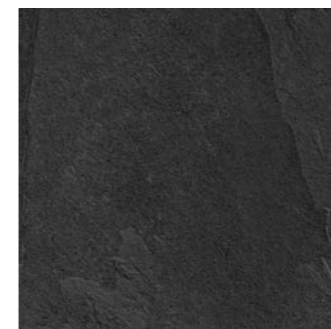

60x60cm / 24"x24"
lapp. rett. (spessore 10,5mm) LGWWFX0
nat. rett. (spessore 10,5mm) LGWWFNO
*grip rett. (spessore 10,5mm) LGWWF00

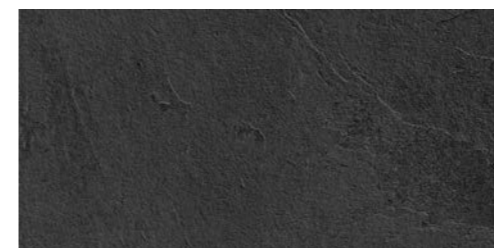

45x90cm / 18"x36"
lapp. rett. (spessore 10,5mm) LGGWFX0
nat. rett. (spessore 10,5mm) LGGWFNO

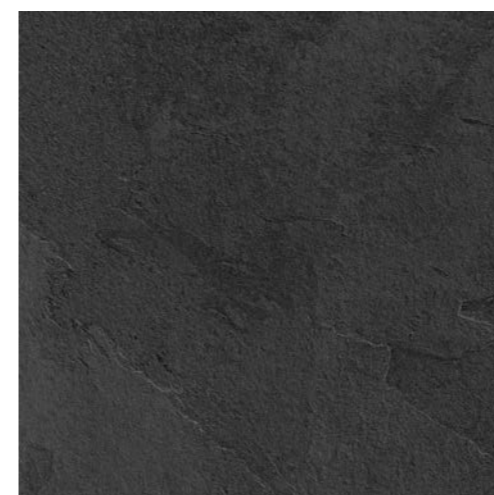

90x90cm / 36"x36"
lapp. rett. (spessore 10,5mm) LG9WFX0
nat. rett. (spessore 10,5mm) LG9WF00

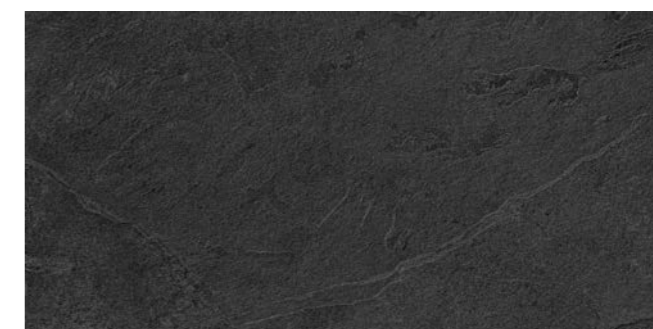

60x120cm / 24"x48"
lapp. rett. (spessore 10,5mm) LGXWFX0
nat. rett. (spessore 10,5mm) LGXWF00

*non trattato con antibatterico
without antimicrobial treatment
sans traitement antibacterien
nicht mit antibakterieller
Wirkung ausgestattet

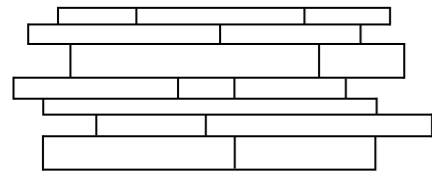

MURETTO
30x60cm / 12"x24"
ivory flow lapp.
silver flow lapp.
gray flow lapp.
dark flow lapp.

LG9WFM2
LG9WFM3
LG9WFM1
LG9WFM0

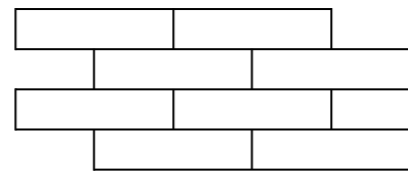

BRICK
30x60cm / 12"x24"
ivory flow lapp.
silver flow lapp.
gray flow lapp.
dark flow lapp.

LGVWF20
LGVWF30
LGVWF10
LGVWF00

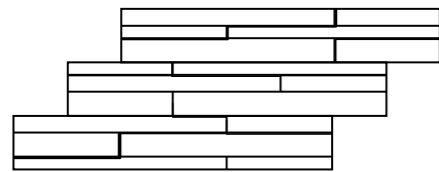

MURETTO 3D
30x60cm / 12"x24"
ivory flow lapp.
silver flow lapp.
gray flow lapp.
dark flow lapp.

LGVWFD2
LGVWFD3
LGVWFD1
LGVWFD0

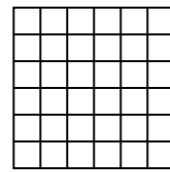

MOSAICO 36
30x30cm / 12"x12"
ivory flow lapp.
silver flow lapp.
gray flow lapp.
dark flow lapp.

LGCWF20
LGCWF30
LGCWF10
LGCWF00

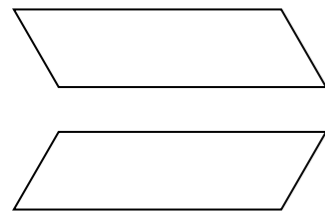

GRAMMA 72
49,8x16,9cm / 19 1/2"x6 5/8"
ivory flow nat.
silver flow nat.
gray flow nat.
dark flow nat.

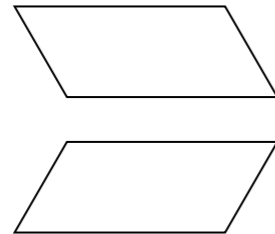

GRAMMA 66
39,2x19,5cm / 15 3/8"x7 5/8"
ivory flow nat.
silver flow nat.
gray flow nat.
dark flow nat.

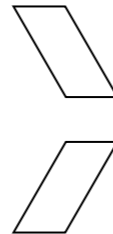

GRAMMA 16
19,5x9,7cm / 7 5/8"x3 3/4"
ivory flow nat.
silver flow nat.
gray flow nat.
dark flow nat.

BASKET / Gramma 66 - Gramma 16

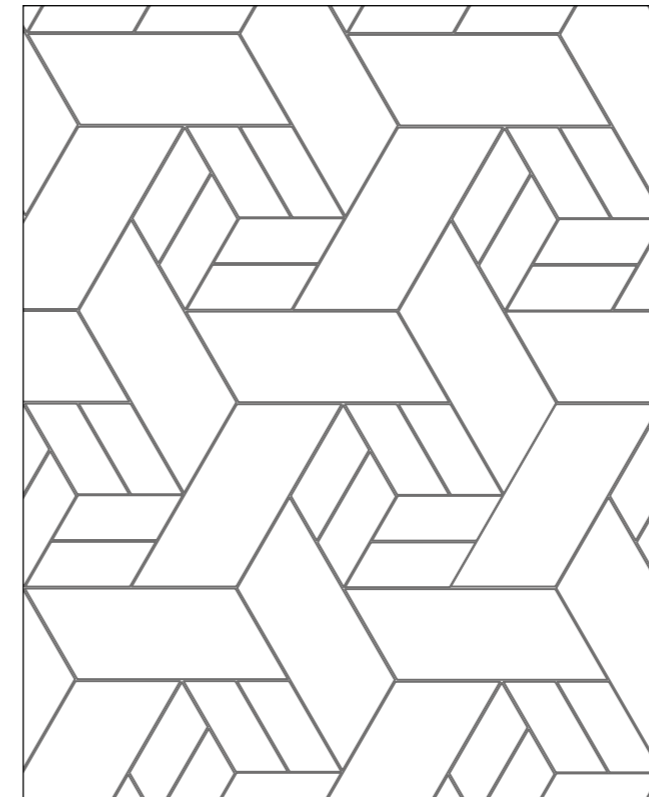

TWIST / Gramma 66

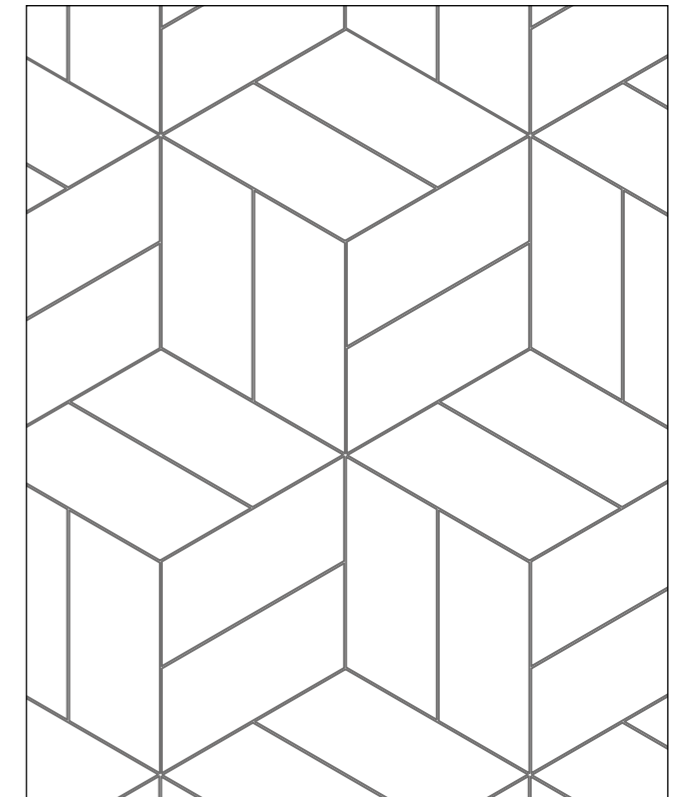

CHEVRON / Gramma 72

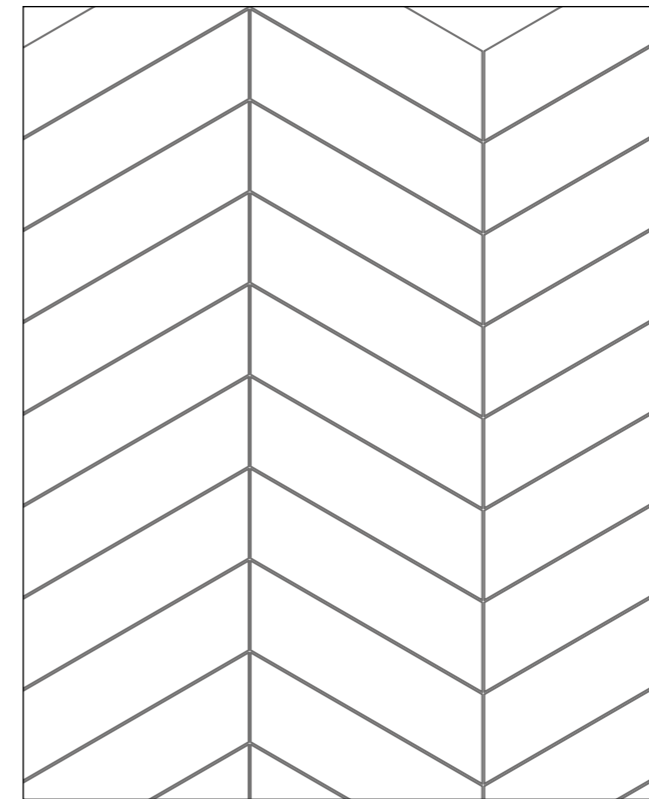

ARROW / Gramma 66

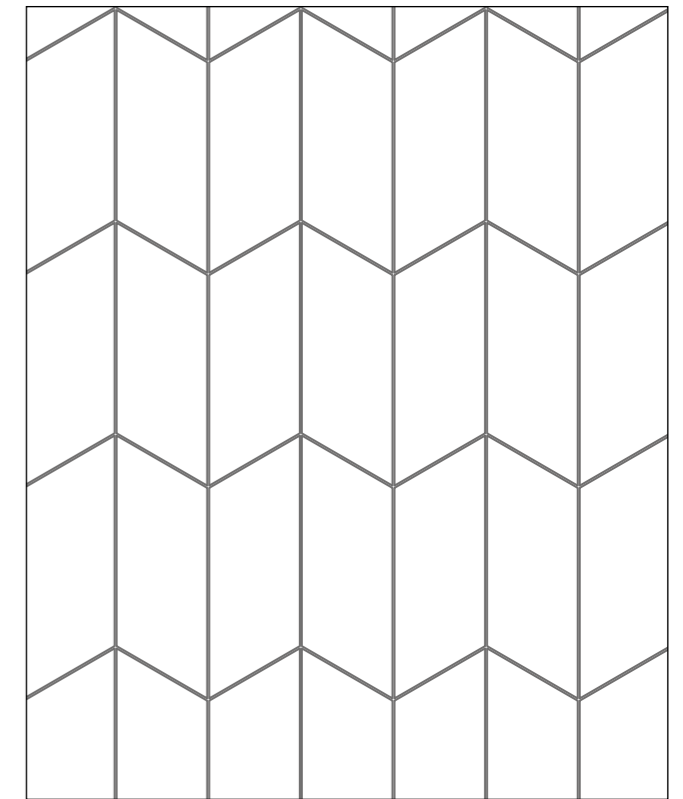

LAPPATA

ANGOLO SX GRADINO PLUS lapp. rett.*
35x120cm / 13^{3/4}"x48"
ivory flow LG8WF72
silver flow LG8WF82
gray flow LG8WF62
dark flow LG8WF52

GRADINO PLUS lapp. rett.*
35x120cm / 13^{3/4}"x48"
ivory flow LG8WF70
silver flow LG8WF80
gray flow LG8WF60
dark flow LG8WF50

ANGOLO DX GRADINO PLUS lapp. rett.*
35x120cm / 13^{3/4}"x48"
ivory flow LG8WF71
silver flow LG8WF81
gray flow LG8WF61
dark flow LG8WF51

BATTISCOPA lapp. rett.
10x60cm / 4"x24"
ivory flow LGBWFL2
silver flow LGBWFL3
gray flow LGBWFL1
dark flow LGBWFLO

NATURALE

ANGOLO SX GRADINO PLUS nat. rett.*
35x120cm / 13^{3/4}"x48"
ivory flow LG8WF22
silver flow LG8WF32
gray flow LG8WF12
dark flow LG8WF02

GRADINO PLUS nat. rett.*
35x120cm / 13^{3/4}"x48"
ivory flow LG8WF20
silver flow LG8WF30
gray flow LG8WF10
dark flow LG8WF00

ANGOLO DX GRADINO PLUS nat. rett.*
35x120cm / 13^{3/4}"x48"
ivory flow LG8WF21
silver flow LG8WF31
gray flow LG8WF11
dark flow LG8WF01

BATTISCOPA nat. rett.
10x60cm / 4"x24"
ivory flow LGBWFN2
silver flow LGBWFN3
gray flow LGBWFN1
dark flow LGBWFNO

GRIP

ANGOLO GRADINO PLUS grip rett.*
35x35cm / 13^{3/4}"x13^{3/4}"
ivory flow LG2WF21
silver flow LG2WF31
gray flow LG2WF11
dark flow LG2WF01

GRADINO PLUS grip rett.*
35x60cm / 13^{3/4}"x24"
ivory flow LG2WF20
silver flow LG2WF30
gray flow LG2WF10
dark flow LG2WF00

SEZIONE GRADINO

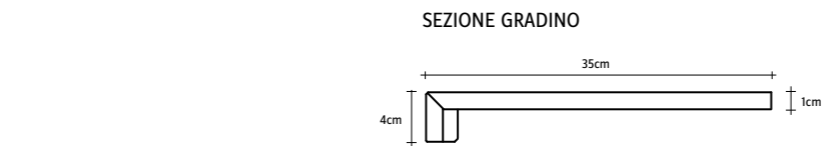
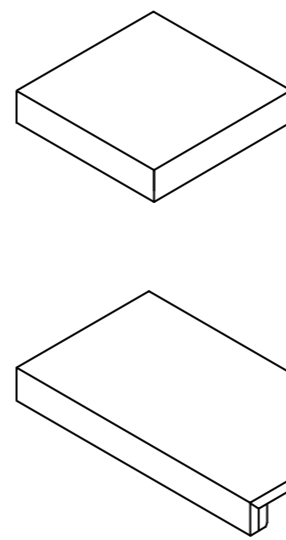
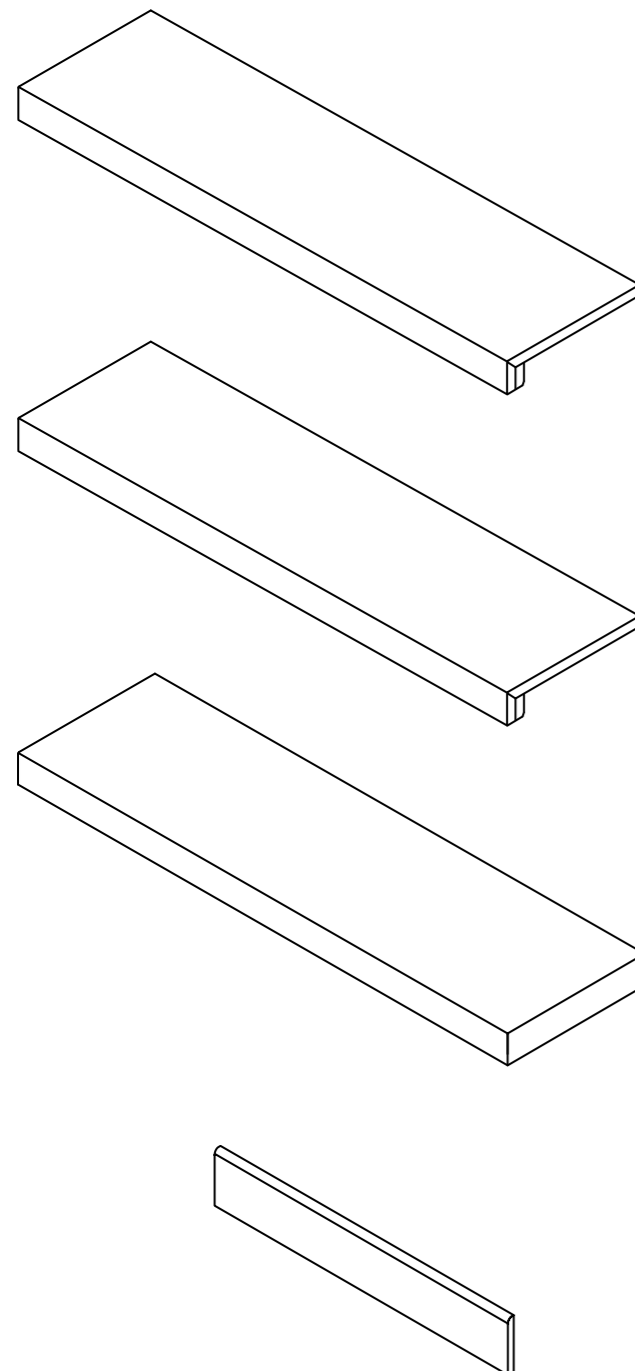
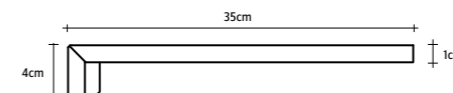

*su richiesta. Per maggiori informazioni circa quantità minime e tempi di consegna rivolgersi all'ufficio commerciale.
upon request. For more information about minimum quantities and delivery times please contact the sales department.
sur demande. Pour plus d'informations sur les quantités minimales et délais de livraison s'il vous plaît contacter le département des ventes.
auf Anfrage. Für weitere Infos über die Mindestmengen und Lieferzeiten wenden Sie sich bitte an unserer Verkaufsabteilung.

FORMATI E COLORI 20mm

SIZES AND COLORS 20mm_FORMATS ET COULEURS 20mm_FORMATE UND FARBEN 20mm

IVORY FLOW



45x90cm / 18"x36"
rett. (spessore 20mm)

LGGK220

SILVER FLOW

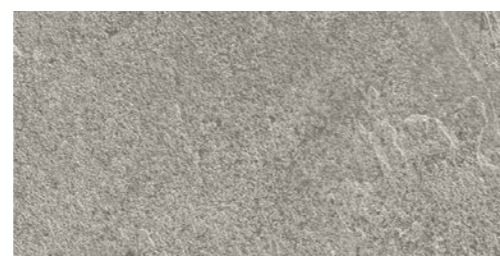

45x90cm / 18"x36"
rett. (spessore 20mm)

LGGK230

GRAY FLOW



45x90cm / 18"x36"
rett. (spessore 20mm)

LGGK210

DARK FLOW

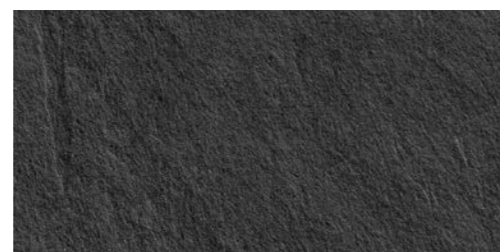

45x90cm / 18"x36"
rett. (spessore 20mm)

LGGK200

PEZZI SPECIALI 20mm

TRIMS 20mm_PIECES SPÉCIALES 20mm_FORMSTÜCKE 20mm

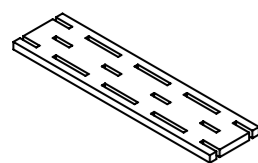

GRIGLIA rett.*
15x45cm / 6"x18"
ivory flow
silver flow
gray flow
dark flow

LGDK2Z2
LGDK2Z3
LGDK2Z1
LGDK2Z0

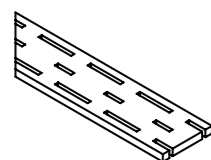

GRIGLIA ANGOLARE SX rett.*
15x45cm / 6"x18"
ivory flow
silver flow
gray flow
dark flow

LGDK2A5
LGDK2A7
LGDK2A3
LGDK2A1

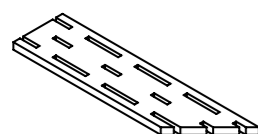

GRIGLIA ANGOLARE DX rett.*
15x45cm / 6"x18"
ivory flow
silver flow
gray flow
dark flow

LGDK2A4
LGDK2A6
LGDK2A2
LGDK2A0

PEZZI SPECIALI 20mm

TRIMS 20mm_PIECES SPÉCIALES 20mm_FORMSTÜCKE 20mm

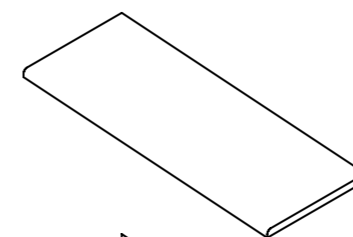

COSTA TORO rett.*
30x90cm / 12"x36"
ivory flow
silver flow
gray flow
dark flow

LGFK2F2
LGFK2F3
LGFK2F1
LGFK2F0

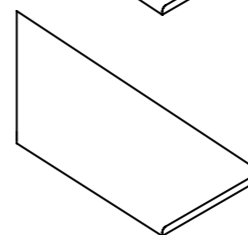

COSTA TORO ANGOLARE SX rett.*
30x90cm / 12"x36"
ivory flow
silver flow
gray flow
dark flow

LGFK2K5
LGFK2K7
LGFK2K3
LGFK2K1

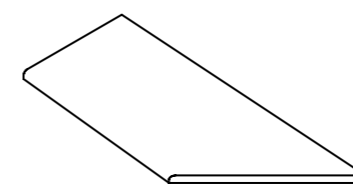

COSTA TORO ANGOLARE DX rett.*
30x90cm / 12"x36"
ivory flow
silver flow
gray flow
dark flow

LGFK2K4
LGFK2K6
LGFK2K2
LGFK2K0

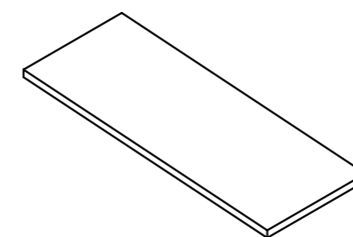

COSTA RETTA rett.*
30x90cm / 12"x36"
ivory flow
silver flow
gray flow
dark flow

LGFK2C2
LGFK2C3
LGFK2C1
LGFK2C0

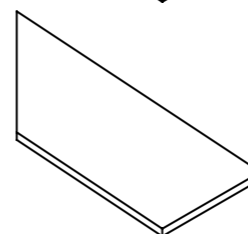

COSTA RETTA ANGOLARE SX rett.*
30x90cm / 12"x36"
ivory flow
silver flow
gray flow
dark flow

LGFK2D5
LGFK2D7
LGFK2D3
LGFK2D1

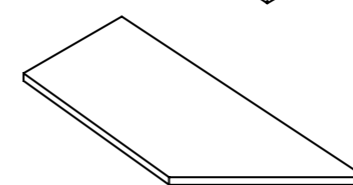

COSTA RETTA ANGOLARE DX rett.*
30x90cm / 12"x36"
ivory flow
silver flow
gray flow
dark flow

LGFK2D4
LGFK2D6
LGFK2D2
LGFK2D0

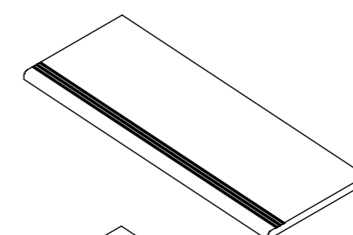

COSTA TORO STEP rett.*
30x90cm / 12"x36"
ivory flow
silver flow
gray flow
dark flow

LGFK2J2
LGFK2J3
LGFK2J1
LGFK2J0

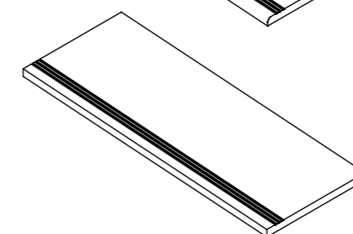

COSTA RETTA STEP rett.*
30x90cm / 12"x36"
ivory flow
silver flow
gray flow
dark flow

LGFK2G2
LGFK2G3
LGFK2G1
LGFK2G0

*su richiesta. Per maggiori informazioni circa quantità minime e tempi di consegna rivolgersi all'ufficio commerciale.
upon request. For more information about minimum quantities and delivery times please contact the sales department.
sur demande. Pour plus d'informations sur les quantités minimales et délais de livraison s'il vous plaît contacter le département des ventes.
auf Anfrage. Für weitere Infos über die Mindestmengen und Lieferzeiten wenden Sie sich bitte an unserer Verkaufsabteilung.

WATERFALL

gres tutta massa UGL
full-body porcelain UGL

spessore 10,5mm / 20mm
thickness

**CONFORME
ACCORDING TO:
ISO 13006 G - EN 14411 G - B1a UGL
ANSI A137.1 - UNGLAZED PORCELAIN TILES CLASS P1**

CARATTERISTICA TECNICA TECHNICAL FEATURES	metodo di prova test method	requisiti prescritti required values	valori medi average values
assorbimento d'acqua water absorption	ISO 10545-3 ASTM C373	≤ 0,5%	0,05%
sforzo di rottura (S) breaking strength	ISO 10545-4 ASTM C648	≥ 1300 N ≥ 250 lbf	2500 N (10,5mm) 13600 N (20mm) 600 lbf (10,5mm) 2800 lbf (20mm)
resistenza a flessione modulus of rupture	ISO 10545-4 ASTM C1505	≥ 35 N/mm ² no provision	≥ 50 N/mm ² ≥ 6500 PSI
resistenza all'abrasione profonda deep abrasion resistance	ISO 10545-6 ASTM C1243	≤ 175 mm ³	≤ 145 mm ³
dilatazione termica lineare linear thermal expansion	ISO 10545-8 ASTM C372	requisito non previsto no provision	$\alpha \leq 7 \cdot 10^{-6} \text{ } ^\circ\text{C}^{-1}$ $\alpha \leq 4.4 \cdot 10^{-6} \text{ } ^\circ\text{F}^{-1} / \alpha \leq 8 \cdot 10^{-6} \text{ } ^\circ\text{C}^{-1}$
resistenza alle macchie stain resistance	ISO 10545-14 ASTM C1378	Classe / Class 3 Min. as indicated by manufacturer	5 RESISTENTE / RESISTANT A RESISTANT
resistenza all'attacco chimico* chemical resistance*	ISO 10545-13 ASTM C650	come indicato dal produttore as indicated by manufacturer	ULA - UHA RESISTENTE / RESISTANT A RESISTANT
resistenza al gelo frost resistance	ISO 10545-12 ASTM C1026	nessuna alterazione / no alteration as indicated by manufacturer	RESISTENTE / RESISTANT RESISTANT
resistenza allo scivolamento slip resistance	DIN 51130 DIN 51097 BCR-TORTUS ANSI A137.1 AS-NZS 4586	- - - DCOF ≥ 0.42 -	R10 (nat.) / R11 (grip - 20mm) B (A+B) (nat.) / C (A+B+C) (grip - 20mm) $\mu > 0,40$ (nat. - grip - 20mm) DCOF ≥ 0.42 (nat. - grip - 20mm) P4 (W) (grip - 20mm)
reazione al fuoco - fire reaction flame spread	EN 13823 EN 9239-1 ASTM E84	CPR (UE) 305/2011, 2000/147/CE, UNI EN 13501-1 -	Classe / Class A1 (wall) Classe / Class A1 _f (floor) Class A
robinson floor tester	ASTM C627	come indicato dal produttore as indicated by manufacturer	≥ 14 cycles Extra Heavy Commercial (over concrete)
conducibilità termica thermal conductivity	EN 12524	-	$\lambda = 1,3 \text{ W/m}^\circ \text{ K} - 0.7 \text{ Btu/ft h}^\circ \text{ F}$
fuga minima consigliata** recommended minimum joint**	RETT-RECT (indoor) ESTERNO / OUTDOOR	- -	2mm 5mm circa / approx.
stonalizzazione shade variation	ANSI A137.1	come indicato dal produttore as indicated by manufacturer	V3

*ad esclusione dell'acido fluoridrico e derivati
excluding hydrofluoric acid and derivatives

**salvo diversa indicazione dei Codici di Posa Nazionali. La larghezza delle fughe deve comunque essere decisa dalla Direzione Lavori
the width of grout joints must be established by the installation supervisor, unless grout widths are regulated by national laying standards

IMPIEGHI USES EMPLOI ANWENDUNGSBEREICHE

alberghi hotels hotels hotels	locali pubblici public spaces lieux publics öffentliche bereiche
abitazioni housing maisons wohnbereiche	aeroporti airports aéroports flughafen
bar - ristoranti bar - restaurants bar - restaurants cafés - restaurants, gasthäuser	centri commerciali malls centre commerciaux einkaufszentren
negozi shops magasins geschäfte	stazioni train stations gares bahnhöfe

IMPIEGHI 20mm USES EMPLOI ANWENDUNGSBEREICHE

vialetti walkways allées Kleine Wege	parcheggi parking areas parkings Parkplätze
parchi pubblici - giardini public parks - gardens parcs publics et jardins Öffentliche Parks und Gärten	terrazze terraces terrasses Terrassen
camminamenti piscine pool decks voies piétonnes et piscines Wege und Schwimmbäder	zone industriali industrial areas zones industrielles Industriebereiche
stabilimenti balneari beach resorts établissements balnéaires Badeanstalten	aree urbane urban areas zones urbaines Stadtbereiche

IMBALLAGGI / PACKING / EMBALLAGE / VERPACKUNGEN

articolo	scatola			europallet		
	pz.	mq	kg	scat.	mq	kg
fondo 10,5mm 60x120 24"x48"	2	1,44	35,5	15	21,6	532,5
fondo 10,5mm 90x90 36"x36"	2	1,62	40,0	15	24,3	600,0
fondo 10,5mm 45x90 18"x36"	3	1,22	30,0	30	36,5	900,0
fondo 20mm 45x90 18"x36"	2	0,81	36,2	24	19,4	869,5
fondo 10,5mm 60x60 24"x24"	4	1,44	32,5	32	46,1	1040,0
fondo 10,5 grip 60x60 24"x24"	4	1,44	33,0	32	46,1	1056,0
fondo 10,5 30x60 12"x24"	8	1,44	32,5	32	46,1	1040,0
muretto 30x60 12"x24"	4	0,72	15,6	30	21,6	468,0
muretto 3D 30x60 12"x24"	4	0,68	18,2	30	20,5	546,0
brick 30x60 12"x24"	4	0,72	15,6	30	21,6	468,0
mosaico 36 30x30 12"x12"	5	0,45	10,0	60	27,0	600,0
gramma 72 49,8x16,9 19 1/2"x6 5/8"	-	-	-	-	-	-
gramma 66 39,2x19,5 15 3/8"x7 5/8"	-	-	-	-	-	-
gramma 16 19,5x9,7 7 5/8"x3 3/4"	-	-	-	-	-	-
battiscopa 10x60 4"x24"	12	7,2 m.l.	16,0	60	432,0 m.l.	960,0
gradino plus 35x120 13 3/4"x48"	2	0,84	23,2	16	13,4	371,2
angolo gradino plus 35x120 13 3/4"x48"	1	0,42	12,4	16	6,7	198,4
gradino plus 35x60 13 3/4"x24"	4	0,84	21,2	16	13,4	339,2
angolo gradino plus 35x35 13 3/4"x13 3/4"	2	0,25	6,7	36	8,8	241,2
costa toro 30x90 12"x36"	1	0,27	12,2	32	8,6	390,4
costa toro angolare 30x90 12"x36"	1	0,23	10,2	32	7,2	326,4
costa retta 30x90 12"x36"	1	0,27	12,2	32	8,6	390,4
costa retta angolare 30x90 12"x36"	1	0,23	10,2	32	7,2	326,4
costa toro step 30x90 12"x36"	1	0,27	12,2	32	8,6	390,4
costa retta step 30x90 12"x36"	1	0,27	12,2	32	8,6	390,4
griglia 15x45 6"x18"	4	0,27	10,0	48	13,0	480,0
griglia angolare 15x45 6"x18"	4	0,23	10,0	48	10,8	480,0



ISO 14001



ISO 9001



emas



leed**



leed*



Le DOP sono disponibili sul sito internet www.ceramichelea.it
DOP are available on the website www.ceramichelea.it

marchio CE

* LEED
Lea Ceramiche, è membro di GBC Italia, organizzazione che promuove sul territorio italiano la realizzazione di edifici nel rispetto dell'ambiente, della salute e del benessere delle persone che ci vivono e lavorano.
Lea Ceramiche is a member of the U.S. Green Building Council: this is an organization that promotes buildings that are environmentally responsible, profitable and healthy places to live and work.

** LEED
Il contenuto di materiale riciclato "pre-consumo" della serie Waterfall è del 40%, come certificato da ente esterno qualificato (certificato disponibile sul sito www.ceramichelea.com).
Waterfall is produced with 40% of pre-consumer materials, as certified by a qualified external company (certificate available on the website www.ceramichelea.com).



ADMEMBER



PROTECT

L'esclusiva tecnologia Panariagroup per pavimenti e rivestimenti antibatterici ad altissime performance. Per un abitare sano, sicuro e protetto.

The exclusive Panariagroup technology for floor and wall coverings with the highest performance. To live healthy, safe and secure.

AZIONE POTENTE
elimina i batteri e ne impedisce la proliferazione

POWERFUL ACTION
eliminates microbes and prevents their reproduction

PROTEZIONE CONTINUA
sempre attivo, 24 ore su 24, con e senza luce solare

PROTECTION CONTINUE
always active, 24 hours a day, with and without sunlight

EFFICACIA ETERNA
grazie alla tecnologia integrata in modo permanente nel prodotto

ETERNAL EFFECTIVENESS
thanks to the technology permanently integrated into the product

QUALITÀ GARANTITA
dalla partnership con MICROBAN®

GUARANTEED QUALITY
by the partnership with MICROBAN®

More on protect.panariagroup.it

WATERFALL

MATERIA MUTEVOLE
VARIABLE MATERIAL

P R () T E C T

SUPERFICIE ANTIBATTERICA
ANTIMICROBIAL SURFACE

with **MICROBAN**[®]

LEA

CERAMICHE

LEA CERAMICHE
Via Cameazzo, 21
41042 Fiorano Modenese
Modena Italy

Tel +39 0536 837811
Fax +39 0536 830326
info@ceramichelea.it
www.ceramichelea.com

Panariagroup Industrie Ceramiche
S.p.A.

SHOWROOM LEA CERAMICHE
Via Durini, 3
20122 Milano

Tel +39 02 76011406
showroom_milano@ceramichelea.it

LEA NORTH AMERICA, LLC
800 Clanton Road, Suite N
Charlotte, NC 28217

Tel +1 704 522 6300
Fax +1 704 522 6080
info@leausa.us
www.leausa.us