

**CONTEMPORARY
CERAMIC
SURFACES**
&
SIGNATURE
SURFACES

Livingceramics

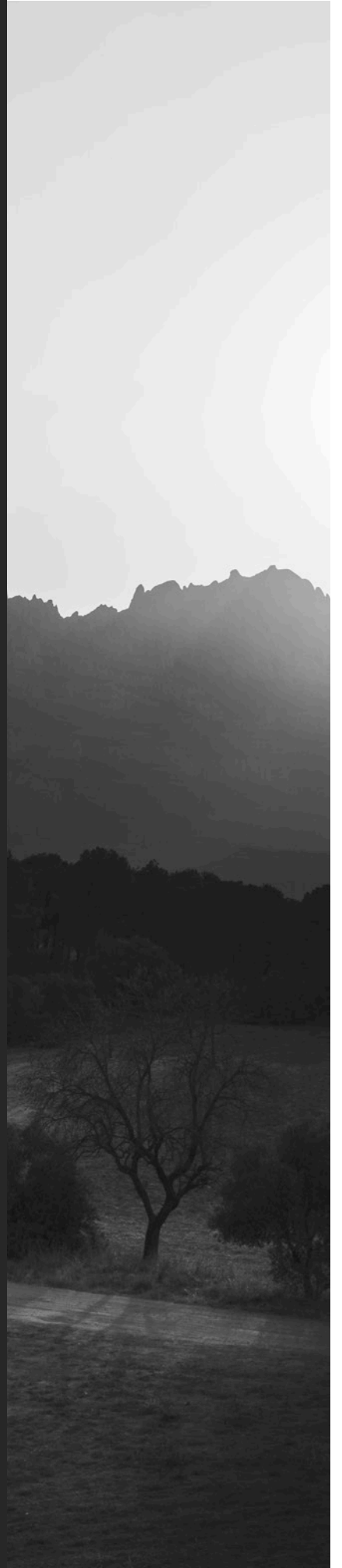

ARCHITECTURE

TEXTURES

SURFACES

CONTEMPORARY CERAMIC SURFACES

*WALL & FLOOR TILES
PORCELAIN
&
WALL TILES
DUCTILE*

Allure

Marbled Stone in Ceramics
Piedra Veteada Cerámica Pag. 59

Bera&Beren

Lusitan & Catalan Limestone Ceramics
Caliza Lusitana & Catalana Cerámica Pag. 63

Blanc

White Marble Stone in Ceramics
Marmol Blanco en Cerámica Pag. 67

Cuit

Mud Art in Ceramics
Arte en Barro Cerámica Pag. 71

Eme

Mediterranean Stone in Ceramics
Piedra mediterránea Cerámica Pag. 75

Floss

Natural Cement Ceramics
Cemento Natural Cerámico Pag. 79

Ground

Mixed Surfaces Ceramics
Mezcla de Superficies Cerámica Pag. 81

Gubi

Microcement Ceramics
Microcemento Cerámico Pag. 83

Kendo

Jura Stone in Ceramics
Piedra Jura en Cerámica Pag. 87

Kovo

Mixed Concrete in Ceramics
Mezcla de Cementos en Cerámica Pag. 91

Noon

Northern Stone in Ceramics
Piedra del Norte Cerámicas Pag. 95

Verso Vein Cut

Travertine Stone in Ceramics
Piedra Travertino en Cerámica Pag. 99

Verso Cross Cut

Travertine Stone in Ceramics
Piedra Travertino en Cerámica Pag. 103

Vonn

Textured Stone in Ceramics
Piedra Texturada en Cerámica Pag. 107

*WALL & FLOOR TILES
THROUGH-BODY PORCELAIN*

Kron Tech

Concrete in Ceramics
Cemento en Cerámica Pag. 123

Wega Tech

Volcanic Stone in Ceramics
Piedra Volcánica Cerámica Pag. 125

WOOD TRIBUTE COLLECTION

*WALL & FLOOR TILES
PORCELAIN*

Due

Natural Brushed Oak in Ceramics
Roble Natural Cepillado en Cerámica Pag. 117

Giro

Natural Pine in Ceramics
Pino Natural en Cerámica Pag. 119

Kora

Wildwood in Ceramics
Madera Salvaje en Cerámica Pag. 121

Niu

French Oak in Ceramics
Roble Francés en Cerámica Pag. 125

Ombra

Rustic Sawn Wood in Ceramics
Madera Rustica Aserrada Cerámica Pag. 127

Rem

Sawn Wood in Ceramics
Madera Aserrada en Cerámica Pag. 129

Riga

Striped Wood in Ceramics
Madera Rayada en Cerámica Pag. 131

Uno

Oak in Ceramics
Roble en Cerámica Pag. 133

*WALL TILES
WHITE BODY*

Mayolica

Natural Mayolica Ceramics
Mayolica Natural Cerámica Pag. 135

SIGNATURE SURFACES

*WALL & FLOOR TILES
PORCELAIN*

Nuer

by KensakuOshiro Pag. 138

Bisel

by VictorCarrasco Pag. 142

Balance

by VictorCarrasco Pag. 148

Cava

by LucidiPevere Pag. 152

*TECHNICAL INFORMATION
INFORMACIÓN TÉCNICA*

**DISCOVER OUR SHOWROOM
COME WITH US** Pag. 156

**ZOMM.
THICKNESS FLOOR** Pag. 158

**Special Pieces
Standard Step Tiles
& Pool Special Pieces** Pag. 162

**BATHROOM
FURNITURE
SERIES** Pag. 165

**Recommendations
Recomendaciones** Pag. 167

**Sales Conditions
Condiciones de Venta** Pag. 168

Livingceramics

On a trip, the only important thing is not the destination. The road that leads us to it can be just as exciting if we are open to live it to the fullest. The path of exploration, research and meticulous and perfectionist elaboration makes the difference. And we are not talking about ceramics, we are talking about sensations. Those that come from making the journey of creation, a work of art.

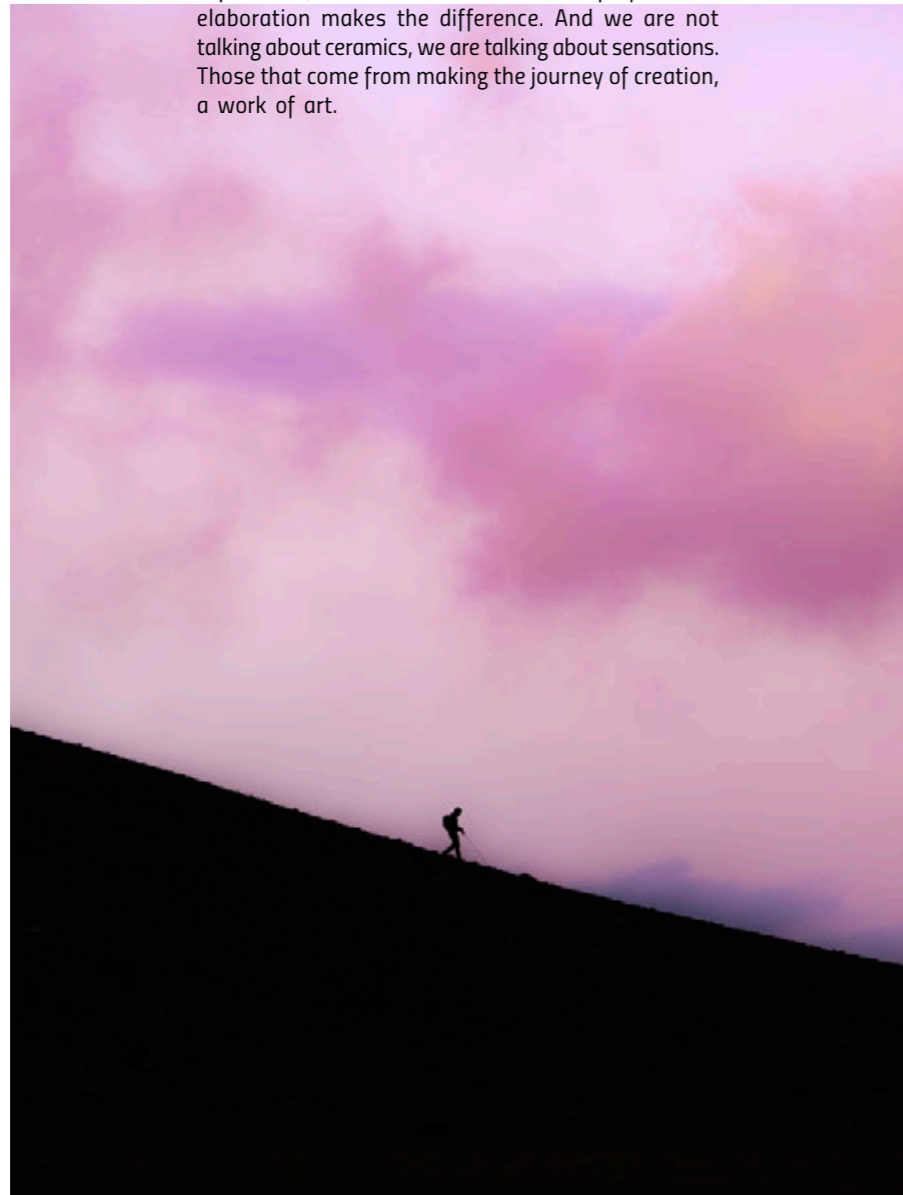

En un viaje, lo único importante no es el destino. La ruta que nos lleve a él puede ser igual de apasionante si estamos abiertos a vivirla plenamente. El camino de exploración, investigación y elaboración minuciosa, marca la diferencia. Y no estamos hablando de cerámica, estamos hablando de sensaciones. Esas que llegan a partir de hacer del proceso de creación, una obra de arte.



“It’s all about the journey speaks of a trip that fills the lungs with air, the mind with ideas and the heart with intense heartbeats”

“It’s all about the journey habla de un viaje que llena los pulmones de aire, la mente de ideas y el corazón de latidos intensos”

Sustainable Tiles Cerámica Sostenible

At Living we work under the criteria of respect for the environment, sustainability and work ethics. This philosophy has led us to join the Green Building Council, a non-profit association made up of companies that work to make our environments sustainable and responsible. We ensure energy efficiency by training our team on the subject, and we are working on a plan for new measures to help reduce our environmental impact. All our packaging is recyclable. Even the catalogue you are holding in your hands has been designed with FSC papers that guarantee a controlled repopulation of one of our greatest legacies, the forests.

Desde Living, trabajamos bajo los criterios de respeto al medio ambiente, la sostenibilidad y la ética en el trabajo. Esta filosofía nos ha llevado a formar parte del Green Building Council, una asociación sin ánimo de lucro formada por empresas que trabajamos para que nuestros entornos sean sostenibles y responsables. Velamos por la eficiencia energética formando a nuestro equipo en la materia, y trabajamos en un plan de nuevas medidas que contribuyan a reducir el impacto medioambiental. Todos nuestros envases y embalajes son reciclables. Incluso el catálogo que tienes entre las manos, se ha diseñado utilizando papeles FSC que avalan una repoblación controlada de uno de nuestros mayores legados, los bosques.

GREEN BUILDING MEMBER / MIEMBRO DEL GREEN BUILDING COUNCIL
CERTIFIED COMPANY ISO 9001 / EMPRESA CERTIFICADA ISO 9001
USE OF CERTIFICATE FSC PAPER / USO DE PAPEL CON CERTIFICADO FSC



The Smart Factory La Fábrica Inteligente



We understand that our parts must be unique and irreplaceable, which is why we have invested in the most advanced systems of production that exist in the market, never before present in the sector.

Looking to the future, we wanted to design a smart material, a product without limitations or restrictions for the most demanding architecture, capable of adapting to the most special projects. The special format of these pieces, up to 120x270cm, allows covering the space from floor to ceiling with a single piece, creating an infinity effect to the eye.

Entendemos que nuestras piezas deben ser únicas e irremplazables, es por ello por lo que hemos invertido en los sistemas de producción más vanguardistas que existen en el mercado, nunca antes presentes en el sector.

Con vistas al futuro, hemos querido diseñar un material inteligente, un producto sin limitaciones ni restricciones para la arquitectura más exigente, capaz de adaptarse a los proyectos más especiales. El formato de estas piezas, de 120x270cm, permite recubrir el espacio de suelo a techo con una sola pieza, creando un efecto de infinitud a la vista.

High Performance Tiles Cerámica de Alto Rendimiento

The full body porcelain tile delivers certain advantages vs other collections, without losing all benefits the glaze porcelain offers, its main feature resides in its inside. The raw material that shapes the tile become uniform without any superficial decoration that delivers the same aesthetic throughout the tile, this particularity make it the best fit for all those spaces that demand the most hard wearing materials.

La cerámica técnica de alto rendimiento confiere ciertas ventajas con respecto a otras colecciones. Sin dejar de ofrecer todos los beneficios de un Porcelánico, su característica más evidente se encuentra en su interior. La masa cerámica que conforma la pieza pasa a ser uniforme y deja de utilizarse una decoración superficial, para conferir a toda la pieza el mismo aspecto, incluyendo laterales e interior. Esta particularidad lo hace idóneo para revestir espacios con alto tráfico peatonal sometidos a un gran desgaste y que necesiten de un pavimento que ofrezca las más altas garantías superficiales.





Honed

Surface finish with a soft and pleasant touch, made by lapping that respects the digital texture of the piece, which coincides with its graphic and gives a great realism to the surface of the material.

Acabado superficial de tacto suave y agradable, realizado mediante un lapado que respeta el relieve digital de la pieza, el cual coincide con la gráfica de la misma y que dota de un gran realismo a la superficie del material.

Natural

Matt finish with soft touch that's influenced by the natural stone with smooth surface.

Acabado mate de tacto suave que reproduce la piedra natural de superficie lisa.

Soft Texture

Matt finish with 3D-Fit® technology that delivers textures in line with the graphics. Soft touch that is inspired by the natural stone.

Acabado mate con tecnología 3D-Fit® que otorga textura en concordancia con la gráfica. Tacto suave inspirado en la piedra natural.

Anti-Slip

Our new anti-slip finish presents a new smoother appearance, while maintaining all the properties that guarantee total user safety to be used on outdoor surfaces and wet areas, such as the edges of swimming pools or snow and rain climates.

Nuestro nuevo acabado antideslizante presenta un nuevo aspecto más suave, al tiempo que mantiene todas las propiedades que garantizan la total seguridad del usuario para poder ser utilizado en superficies de exterior y zonas húmedas, como los bordes de piscinas o climas de nieve y lluvia.

Bush Hammered B.H. Anti-Slip

Extra smooth and matte surface finish, which adds depth to the graphic and highlights the nuances of the designs of the pieces.

Acabado superficial extra suave y mate, el cual aporta profundidad a la gráfica y resalta los matices de los diseños de las piezas.

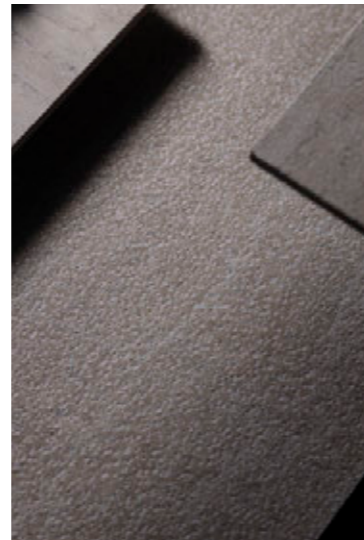

Corelith® Technology

Livingceramics introduces you to the innovative Corelith® technology, which allows us to design the core of the piece of our Tech Series, from the customised selection of each of its components, combined in different proportions, colours and gradings. The design of the core is a fundamental part of the surface appearance of the piece, allowing it to be seen as one whole piece and achieving flawless consistency between the surface, interior and edges. This fact dramatically increases the potential for producing worktops and decorative surfaces with visible edges.

Livingceramics presenta la novedosa tecnología Corelith®. Técnica que nos permite diseñar el núcleo de la pieza de nuestras colecciones de porcelánico técnico, a partir de la selección personalizada de cada uno de sus componentes, combinados en diferentes porcentajes, coloraciones y granulometrías. El diseño del núcleo es parte fundamental de la imagen superficial de la pieza, permitiendo que ésta se entienda como un todo, y consiguiendo una rigurosa similitud entre la superficie, su interior y sus bordes. Hecho que amplía notablemente la posibilidades de realización de encimeras y superficies decorativas con los cantos vistos.

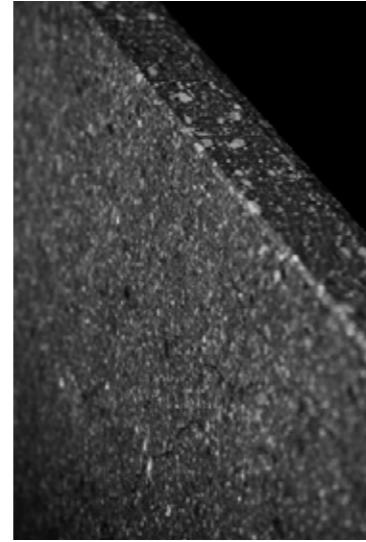

3D-Fit® Technology

Our collections with 3D-Fit® textures involve an innovative technique of graphical 3D digital printing. This process allows the image and the textures of the ceramics to work together perfectly, so that, along with the core designed using Corelith® technology, creates a surface with a much more realistic appearance and provides each piece with a unique and special character.

With materials like wood or stone, this effect could only be achieved if the texture and graphics were intrinsically linked. Now, as a result of our RDI, 3D-Fit® can be applied to a selection of our Series. The highest level of definition to make each surface appear much more realistic.

Nuestras colecciones con relieve 3D-Fit® incluyen una innovadora técnica de inyección gráfica mejorada. Este proceso consigue que la imagen y los relieves de la cerámica casen a la perfección, aportando una textura mucho más realista en la superficie y otorgando a cada pieza un carácter único y especial.

Este efecto sólo podía conseguirse en materiales naturales como la madera o la piedra en los que la textura y la gráfica están intrínsecamente unidos. Ahora, fruto del i+D+i, 3D-Fit® se aplica a una selección de nuestras colecciones. El más alto grado de definición que hace cada superficie, mucho más real.



Ductile



Lighter Más Ligero

Thanks to their slimline 6mm thickness and new formula. Gracias a su espesor de 6 mm. y a una nueva formulación cerámica.



Swifter Más Rápido

Their new formula offsets surface stress, making any cutting work much swifter and cleaner. Su composición evita tensiones superficiales obteniendo cortes rápidos y limpios.



Easier Más Fácil

The tiles ductile properties make them easy to lay, avoiding the need for expensive tile adhesives. La ductilidad de la pieza permite una instalación cómoda, evitando utilizar adhesivos de alto coste.



Eco-Friendlier Más Ecológico

Due to the big reduction in emissions from the manufacturing and transport processes. Reducimos un gran número de emisiones en su fabricación y transporte.

The Ductile collection by Livingceramics stands out for its versatility and simple tile-laying process. A new ceramic material with special characteristics, Ductile can be used to dress up indoor walls in much swifter, more effortless style. Thanks to the tiles' new chemical formula, they can easily be precision cut or drilled. Standard drill bits and cutting discs and less complex tile adhesives can be used with Ductile, cutting tile-laying costs and saving on time.

La versatilidad y facilidad de instalación se representan en la colección Ductile de Livingceramics. Un nuevo material cerámico con unas características muy especiales que hace que revestir interiores se transforme en una tarea mucho más rápida y fácil.

La nueva composición química del material hace que la realización de cortes y perforaciones sea un proceso preciso y simple. Ductile permite utilizar brocas y discos estándar, adhesivos menos complejos en su composición y por ende, abaratar los procesos de instalación y optimizar tiempos.



SME INNOVATIVE / PYME INNOVADORA

The Spanish Ministry for Science, Innovation & Universities rewards Livingceramics efforts in the fields of R&D and innovation.

El Ministerio de Ciencia, Innovación y Universidades reconoce a Livingceramics la inversión en investigación y Desarrollo de productos diferenciadores en la industria cerámica actual.

Livingceramics

CONTEMPORARY CERAMIC SURFACES

Wall&Floor Tiles · Porcelain & Ductile

Allure

Marbled Stone in Ceramics
Piedra Veteada Cerámica

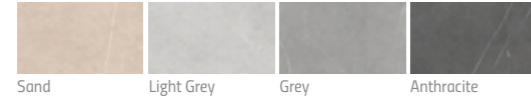

Available
Ductile Relief

Bera&Beren

Lusitan & Catalan Limestone Ceramics
Caliza Lusitana & Catalana Cerámica



Available
Ductile Relief

Blanc

White Marble Stone in Ceramics
Mármol Blanco en Cerámica

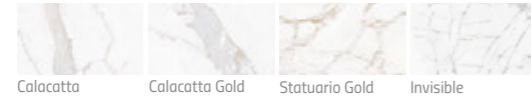

Available
Ductile Relief

Cuit

Mud Art in Ceramics
Arte en Barro Cerámico



Available
Ductile Relief

Ene

Mediterranean Stone in Ceramics
Piedra mediterránea Cerámica

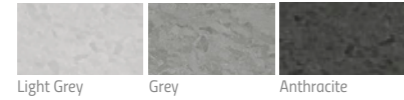

Available
Ductile Relief

Floss

Natural Cement Ceramics
Cemento Natural Cerámico

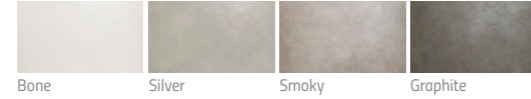

Ground

Mixed Surfaces Ceramics
Mezcla de Superficies Cerámicas

Available
Ductile Relief

Gubi

Microcement Ceramics
Microcemento Cerámico

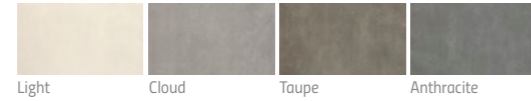

Available
Ductile Relief

Kendo

Jura Stone in Ceramics
Piedra Jura en Cerámica

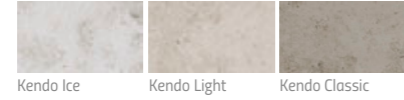

Available
Ductile Relief

Kovo

Mixed Concrete in Ceramics
Mezcla de Cementos en Cerámica

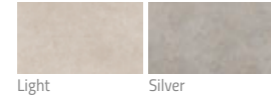

Available
Ductile Relief

Noon

Northern Stone in Ceramics
Piedra del Norte Cerámica

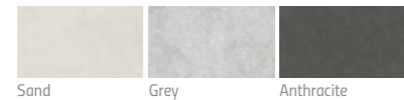

Available
Ductile Relief

Verso Vein Cut

Travertine Stone in Ceramics
Piedra Travertino en Cerámica

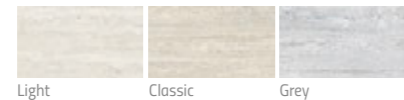

Available
Ductile Relief

Verso Cross Cut

Travertine Stone in Ceramics
Piedra Travertino en Cerámica

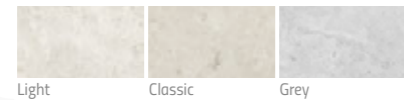

Available
Ductile Relief

Vonn

Textured Stone in Ceramics
Piedra Texturada en Cerámica



Available
Ductile Relief

Kron Tech

Concrete in Tech. Porcelain
Cemento en Porcelánico Téc.

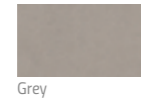

Wega Tech

Volcanic Stone in Tech. Porcelain
Piedra Volcánica en Porcelánico Téc.



WOOD TRIBUTE COLLECTION

Wall & Floor Tiles · Porcelain

Due

Natural Brushed Oak in Ceramics
Roble Natural Cepillado en Cerámica



Giro

Natural Pine in Ceramics
Pino Natural en Cerámica

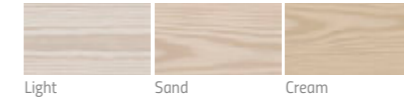

Kora

Wildwood in Ceramics
Madera Salvaje en Cerámica

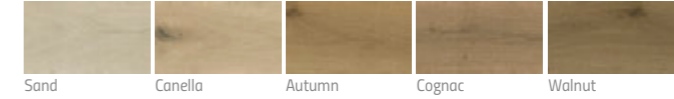

Available
Ductile Relief

Niu

French Oak in Ceramics
Roble Francés en Cerámica

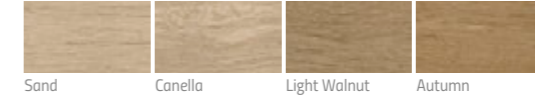

Ombra

Rustic Sawn Wood in Ceramics
Madera Rústica Aserrada Cerámica

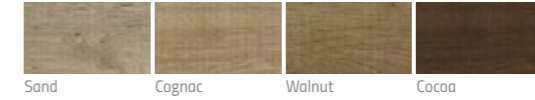

Rem

Sawn wood in Ceramics
Madera Aserrada en Cerámica

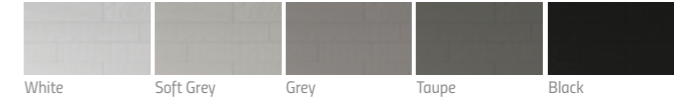

Riga

Striped Wood in Ceramics
Madera Rayada Cerámica

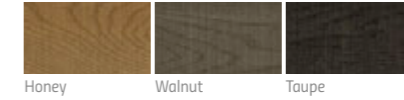

Uno

Oak Ceramics
Roble Cerámico



CONTEMPORARY CERAMIC SURFACES

Wall Tiles · White Body

Mayolica

Natural Mayolica Ceramics
Mayolica Natural Cerámica

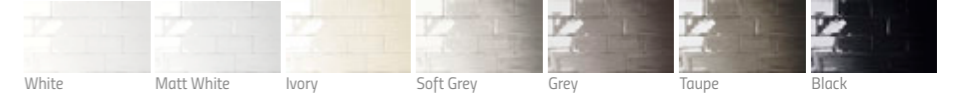

SIGNATURE SURFACES

Wall&Floor Tiles · Porcelain & White Body

Nuer

by KensakuOshiro

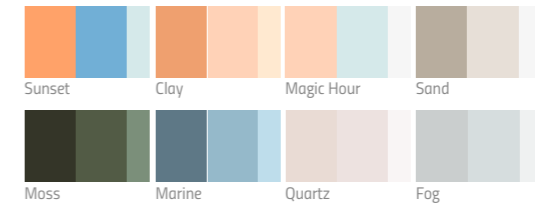

Bisel

by VictorCarrasco

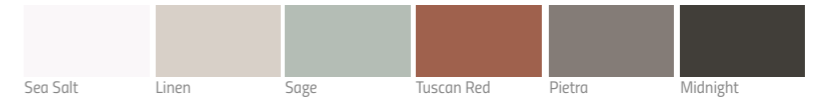

Balance

by VictorCarrasco



Cava

by LucidiPevero

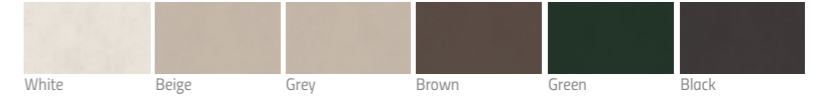

**THE ART OF MIXING
EL ARTE DE COMBINAR**

All our CONTEMPORARY CERAMIC SURFACES collections we are launching from Living suggest a rich blend of materials and finishes. They are designed as a whole, so that they are easy to combine with each other, regardless of the line and the chromatic choice. All the collections are found in a wide range of formats, responding to the contemporary architecture's demands and allowing almost infinite combinations. We have used current technologies such as ceramic color digital printing, and technology forefront methods such as directly printing on the glazing and "mascaring", which have enabled us to create light and beautiful designs with great personality and with unprecedented finishes and textures.

Todas y cada una de las colecciones CONTEMPORARY CERAMIC SURFACES que lanzamos desde Living, proponen una rica mezcla de materiales y acabados. Están concebidas como un todo, de forma que resulta sencillo combinar unas con otras, independientemente de la colección y la elección cromática. Todas las colecciones se encuentran en una amplia variedad de formatos, respondiendo a las exigencias de arquitectura del momento y permitiendo combinaciones cuasi infinitas. Hemos utilizado tecnologías actuales como impresión digital en colores cerámicos, y métodos a la vanguardia de la técnica, como la impresión directa en esmaltes y el mascaring, que nos han permitido crear diseños ligeros y bellos, de gran personalidad y con acabados y texturas inéditas.



Allure Anthracite Soft Textured
120x270 cm. (48"x106")



Bera White Honed
120x270 cm. (48"x106")



Beren Sand Soft Textured
120x270 cm. (48"x106")

Beren Black Natural
90x270 (36"x106")

Bathroom Furniture Series
W.37.90 Bera&Beren Black Natural Basin
20x90x52cm
8"x36"x21"



Beren Light Grey Soft Textured
120x270 cm. (48"x106")



Blanc Calacatta Soft Textured
120x270 cm. (48"x106")

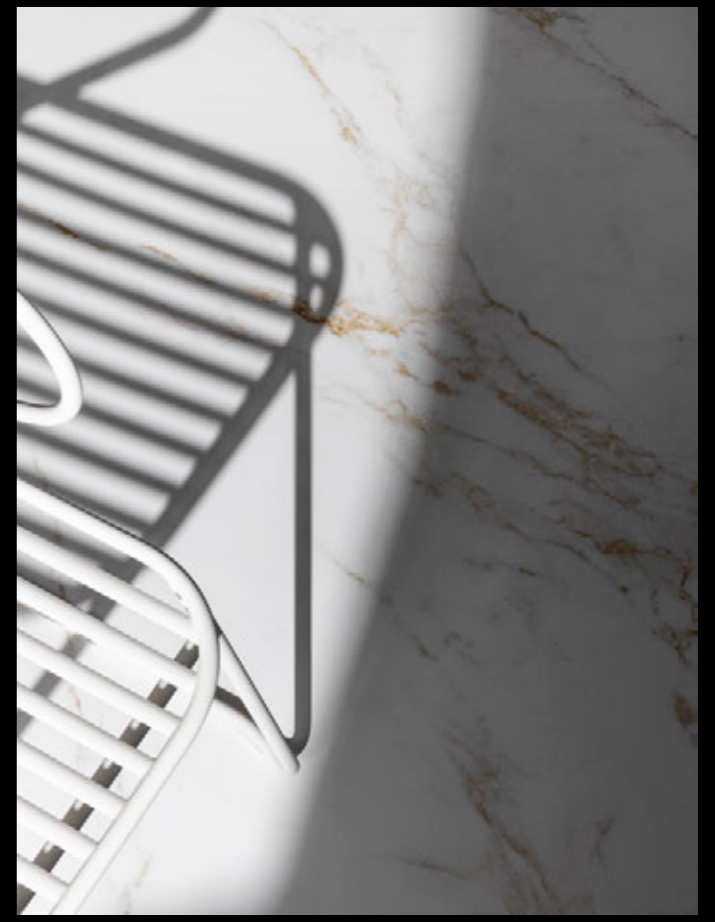

Blanc Statuario Gold Soft Textured
120x120 cm. (48"x48")

Ductile
Blanc Calacatta Cane
60x120 cm. (24"x48")





Cuit Clay Soft Textured
120x270 cm. (48"x106")

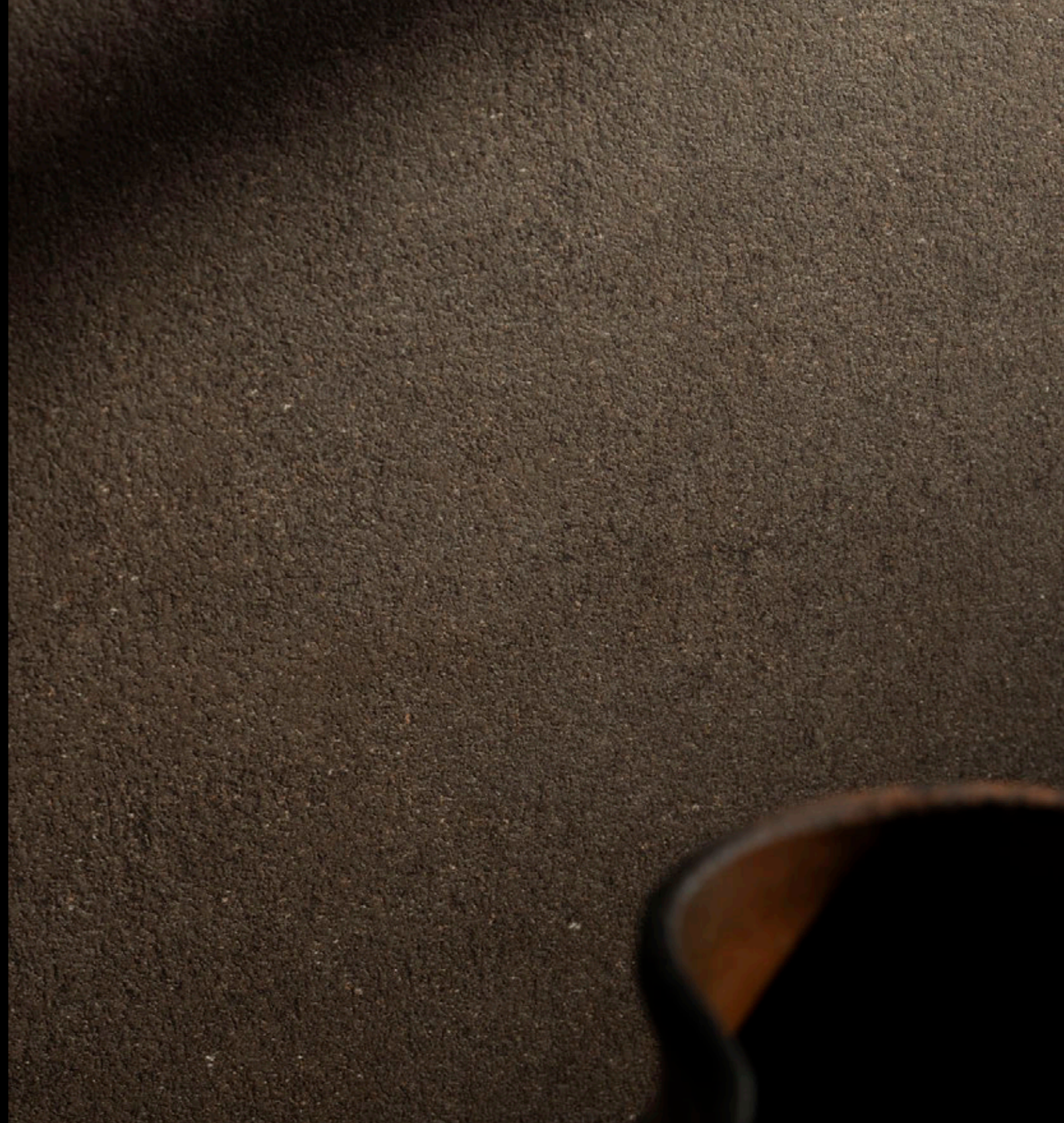

Cuit Clay Soft Textured
120x270 cm. (48"x106")



Eme Grey Soft Textured
120x270 cm. (48"x106")



Bathroom Furniture Series
A.71 Eme Grey Soft Textured



Bathroom Furniture Series
A.71 Eme Grey Soft Textured

Eme Grey Soft Textured
120x270 cm. (48"x106")



Ductile
Eme Light Grey Jazz
60x120 cm. (24"x48")



Ductile
Eme Light Grey Jump
60x120 cm. (24"x48")



Floss Bone Natural
90x90 cm. (36"x36")



Gubi Anthracite Natural
90x90 cm. (36"x36")



Kendo Light Honed
120x270 cm. (48"x106")



Kendo Light Honed
120x270 cm. (48"x106")



Ductile
Kovo Silver Soft Textured
60x120 cm. (24"x48")



Ductile
Noon Sand Soft Textured
90x270 cm. (36"x106")

Bathroom Furniture Series
L.28 [240] Noon Sand Soft Textured Basin
Shadow Dry Oak Frame



Ductile
Noon Light Grey Soft Textured & Noon Light Grey Arrow
60x120 cm. (24"x48")

Noon Light Grey Soft Textured
120x120 cm. (48"x48")



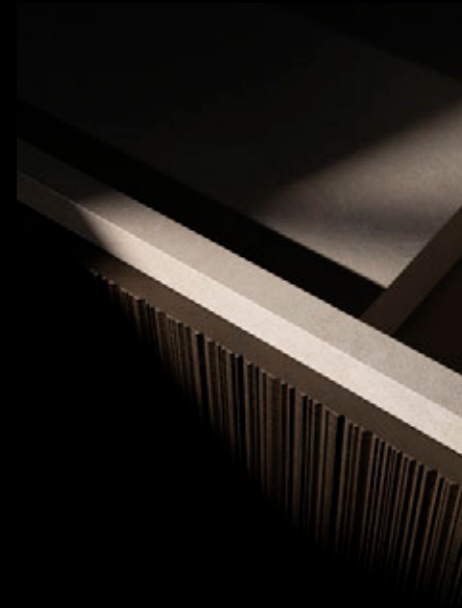

Vonn Light Soft Textured
120x120 cm. (48"x48")

Bathroom Furniture Series
L.28 [240 cm.] Vonn Light Soft Textured
Cross Dry Oak Frame

Vonn Light Honed
120x270 cm. (48"x106")



Ductile
Vonn Grey Leaf
60x120 cm. (24"x48")

Ductile
Vonn Grey Leaf
60x120 cm. (24"x48")

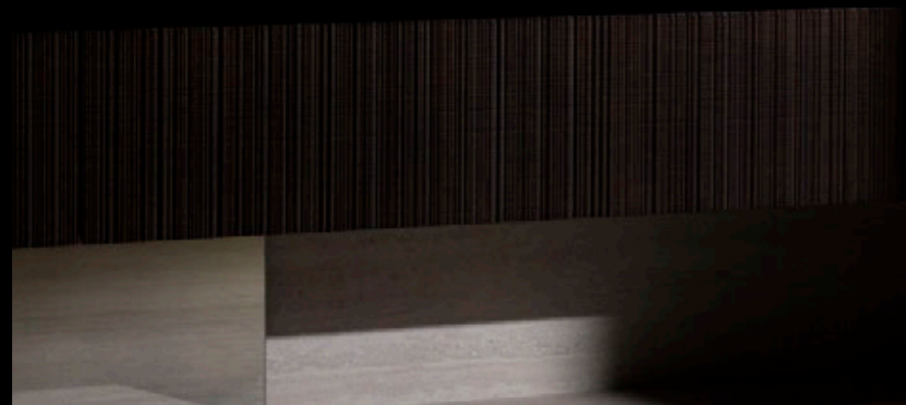

Verso Vein Cut Light Soft Textured
120x270 cm. (48"x106")

Bathroom Furniture Series
A.71 [240 cm.] Verso Vein Cut Light Soft Textured
Cross Dry Oak Line. 240



Verso Vein Cut Light Soft Textured
120x270 cm. (48"x106")



Ductile
Verso Cross Cut Light Arco
60x120 cm. (24"x48")



WOOD TRIBUTE COLLECTION
Rem Black Soft Textured
5x40 cm. (2"x16")

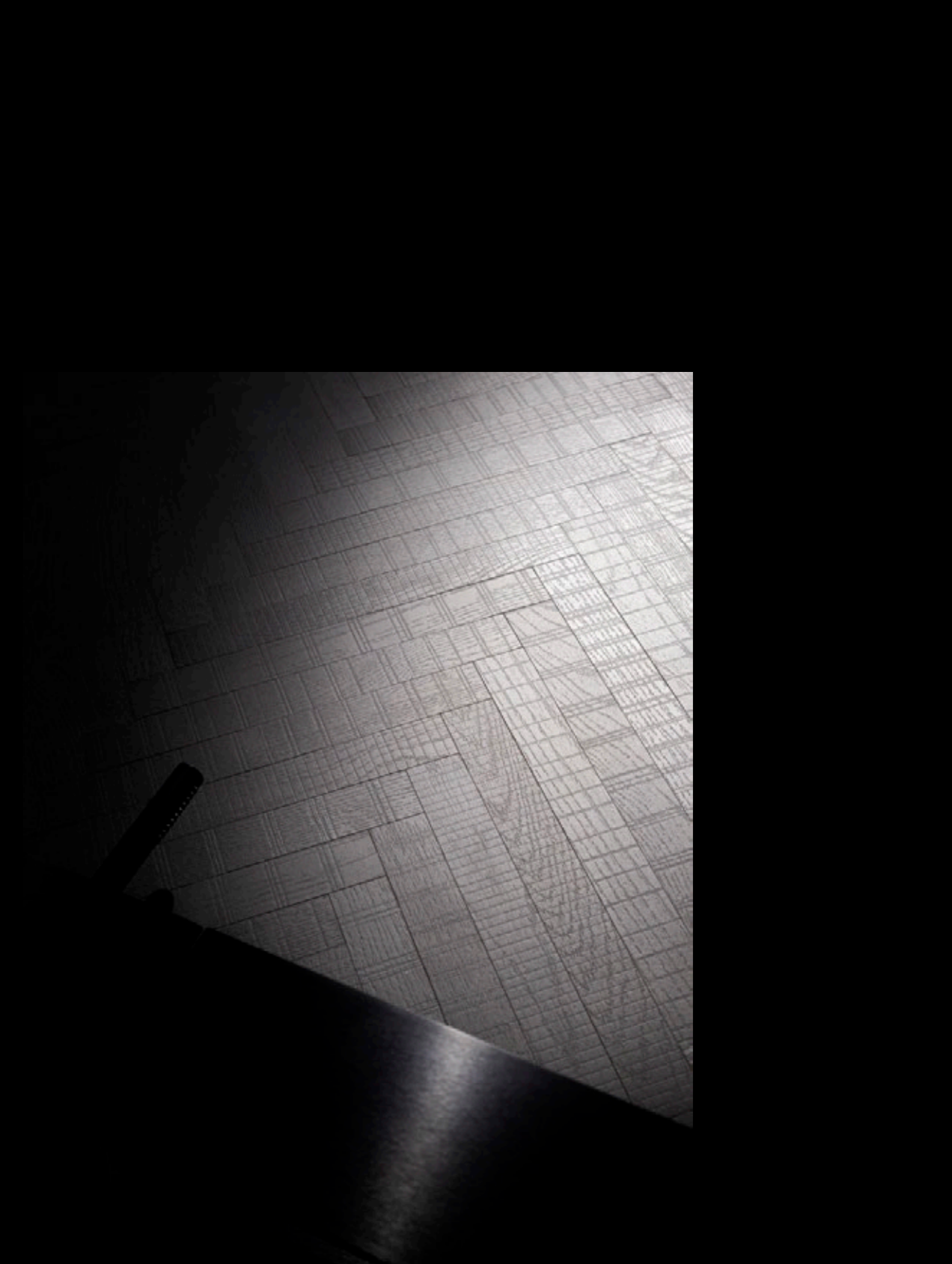

WOOD TRIBUTE COLLECTION
Rem Black Soft Textured
5x40 cm. (2"x16")



WOOD TRIBUTE COLLECTION
Kora Autumn Soft Textured
22,5x200 cm. (9"x79")



WOOD TRIBUTE COLLECTION
Ductile
Kora Autumn Cozy
60x120 cm. (24"x48")



WOOD TRIBUTE COLLECTION
Ductile
Kora Autumn Cozy
60x120 cm. (24"x48")



WOOD TRIBUTE COLLECTION
Due Walnut Soft Textured
22,5x200 cm. (9"x79")





WOOD TRIBUTE COLLECTION
Ombra Cocoa
22,5x200 cm. (9"x79")



WOOD TRIBUTE COLLECTION
Ombra Cocoa Soft Textured
22,5x200 cm. (9"x79")



WOOD TRIBUTE COLLECTION
Riga Taupe Soft Textured
22,5x200 cm. (9"x79")



WOOD TRIBUTE COLLECTION
Niu Autumn Soft Textured
22,5x200 cm. (9"x79")

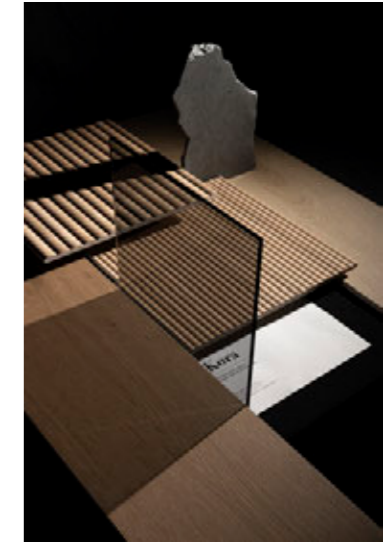

CONTEMPORARY CERAMIC SURFACES & SIGNATURE SURFACES

The Livingceramics catalogue expresses, through these pages, the firm's balance between design and technology. The contemporary inspiration is supported by the detailed technical specifications that you will find below, to serve as a useful working tool for the professional on a daily basis.

El catálogo de Livingceramics expresa, a través de estas páginas, el equilibrio de la firma a nivel diseño y tecnología. La inspiración contemporánea se apoya de las especificaciones técnicas detalladas que encontrarás a continuación, para servir de herramienta de trabajo útil al profesional en el día a día.

Livingceramics

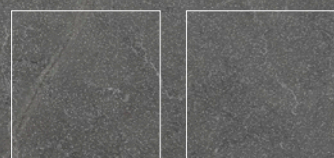
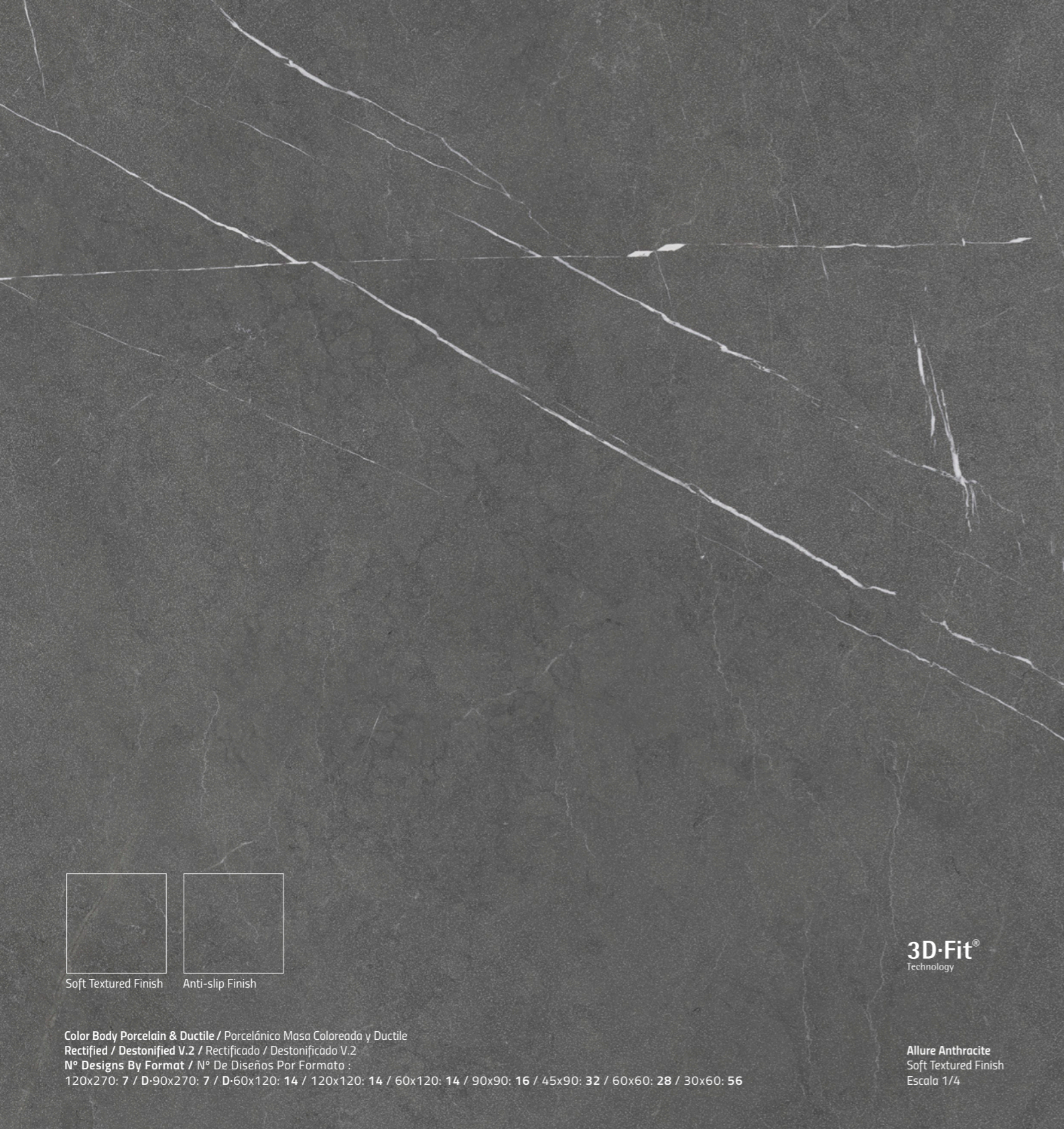

Soft Textured Finish Anti-slip Finish

Color Body Porcelain & Ductile / Porcelánico Masa Coloreada y Ductile
Rectified / Destonified V.2 / Rectificado / Destonificado V.2
N° Designs By Format / N° De Diseños Por Formato :
120x270: 7 / D-90x270: 7 / D-60x120: 14 / 120x120: 14 / 60x120: 14 / 90x90: 16 / 45x90: 32 / 60x60: 28 / 30x60: 56

3D-Fit
Technology

Allure Anthracite
Soft Textured Finish
Escala 1/4

Available Sizes / Formatos Disponibles

Step Tile & Countertops Availables. Consult Special Pieces Section.
Peldaños y Encimeras disponibles. Consulte la Sección de Piezas Especiales.

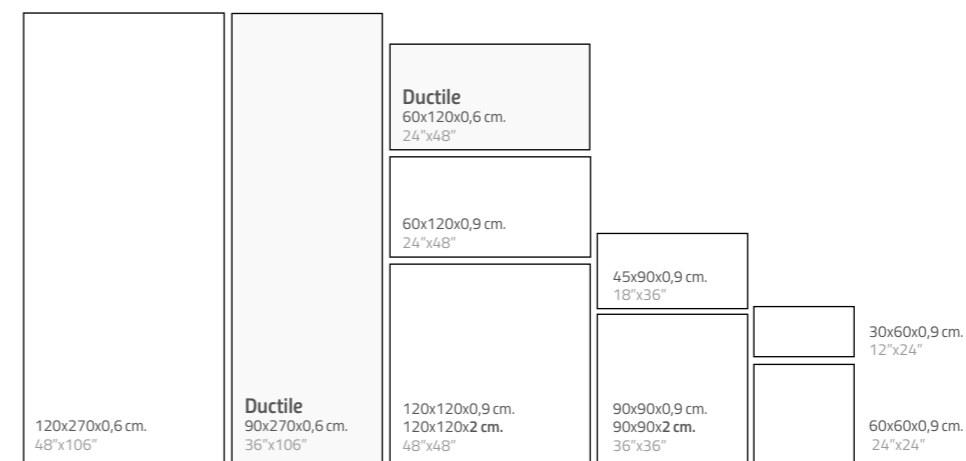

Complements / Complementos

- Deco Mosaic**
Net 24"x24"
Malla 60x60 cm.
Real 59,8x59,8 cm.
- Mosaic 25**
Net 12"x12"
Malla 30x30 cm.
Real 29,8x29,8 cm.
- Mosaic 55**
Net 12"x12"
Malla 30x30 cm.
Real 29,8x29,8 cm.
- Mureto Mosaic**
Net 12"x18"
Malla 30x45 cm.
Real 29,8x29,8 cm.
- Mureto 3D Mosaic**
Net 6"x36"
Malla 15x90 cm.
Real 15x60 cm.

Ductile Wall Tiles Available Sizes & Finishes / Formatos y Acabados Disponibles en Revestimientos Ductile

Nominal Size Formato Nominal	Real Size Formato Real	Soft Textured	Price Code	Pz/Box	M2/Box	Kg/Box	Box/Pa	M2/Pa	Kg/Pa
Ductile 60x120 cm. 24"x48"	59,8x119,8x0,6 cm.	●	620	3	2,15	25,80	24	51,48	649
Ductile 90x270 cm. 36"x106"	89,8x269,8x0,6 cm.	●	970	1	2,42	29,04	24	58,08	801

Porcelain Tiles Available Sizes & Finishes / Formatos y Acabados Disponibles en Porcelánico

Nominal Size Formato Nominal	Real Size Formato Real	Soft Textured C1 · R9 · CA	Anti-Slip C3 · R11 · CC	Price Code	Pz/Box	M2/Box	Kg/Box	Box/Pa	M2/Pa	Kg/Pa
30x60 cm. 12"x24"	29,8x59,8x0,9 cm.	●	●	30	6	1,07	22,00	48	51,36	1094
60x60 cm. 24"x24"	59,8x59,8x0,9 cm.	●	●	60	3	1,07	23,22	40	42,91	962
45x90 cm. 18"x36"	44,8x89,8x0,9 cm.	●	●	45	3	1,21	25,50	32	38,62	849
90x90 cm. 36"x36"	89,8x89,8x0,9 cm.	●	●	90	2	1,61	34,00	24	38,71	846
*90x90x2 cm. 36"x36"	89,8x89,8x2 cm.	●	●	94	1	0,81	37,09	24	19,35	946
60x120 cm. 24"x48"	59,8x119,8x0,9 cm.	●	●	62	2	1,43	30,32	24	34,32	767
120x120 cm. 48"x48"	119,8x119,8x0,9 cm.	●	●	120	1	1,44	30,50	40	57,41	1265
*120x120x2 cm. 48"x48"	119,8x119,8x2 cm.	●	●	121	1	1,44	66,02	16	22,96	1140
120x270 cm. 48"x106"	119,8x269,8x0,6 cm.	●	●	276	1	3,23	45,50	24	77,52	1250
Deco Mosaic	59,8x59,8x0,9 cm.	●	●	560	4	0,92	20,00	24	22,10	510
Mosaic 25	29,8x29,8x0,9 cm.	●	●	25	5	0,44	9,00	60	26,40	576
Mosaic 55	29,8x29,8x0,9 cm.	●	●	55	5	0,44	9,00	60	26,40	576
Mureto Mosaic	29,8x29,8x0,9 cm.	●	●	300	5	0,44	9,00	40	17,60	395
Mureto 3D Mosaic	15x60x0,9 cm.	●	●	595	4	0,35	7,50	20	7,03	175

Available Colours / Colores Disponibles

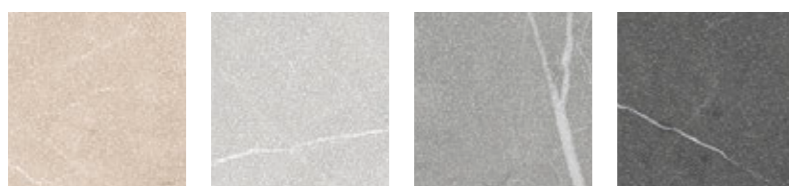

*Allure Sand *Allure Light Grey Allure Grey *Allure Anthracite

*20mm. Thickness Available Colour
*Color Disponible en 20mm.



Allure Anthracite
Line Relief
Graphic Scale 1/4



Allure Anthracite
Wave Relief
Graphic Scale 1/4



Allure Anthracite
Wiggle Relief
Graphic Scale 1/4

3D-Fit®
Technology

Rectified / Destonified V.2 / Rectificado / Destanificado V.2
N° Designs By Format / N° De Diseños Por Formato : D-30X90: 16

Ductile Reliefs

Ductile Wall Tiles · Revestimientos Ductile

Available Sizes / Formatos Disponibles

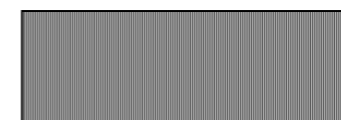

LINE
Ductile
30x90x0,9 cm.
12"x36"

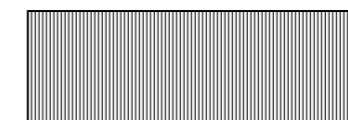

WAVE
Ductile
30x90x0,9 cm.
12"x36"

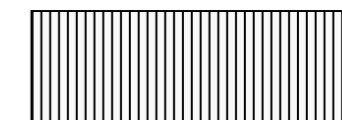

WIGGLE
Ductile
30x90x0,9 cm.
12"x36"

Available Colours / Colores Disponibles



Allure White



Allure Light Grey



Allure Anthracite

Ductile Wall Tiles Available Sizes & Finishes / Formatos y Acabados Disponibles en Revestimientos Ductile

Nominal Size Formato Nominal	Real Size Formato Real	Line	Wave	Wiggle	Price Code	Pz/Box	M2/Box	Kg/Box	Box/Pa	M2/Pa	Kg/Pa
Ductile Relief 30x90 cm. 12"x36"	29,8x89,8x0,9 cm.	●	●	●	320	4	1,07	17,60	48	51,36	870

Bera&Beren

Lusitan & Catalan Limestone Ceramics
Caliza Lusitana & Catalana Cerámica



Color Body Porcelain & Ductile / Porcelánico Masa Coloreada y Ductile
Rectified / Destonified V.2 / Rectificado / Destonificado V.2
N° Designs By Format / N° De Diseños Por Formato :
120x270: 7 / D-90x270: 7 / D-60x120: 14 / 120x120: 14 / 60x120: 14 /
90x90: 16 / 45x90: 32 60x60: 28 / 30x60: 56 / 10x60: 168 / 5x60: 336

Beren Light Grey
Natural Finish
Graphic Scale 1/4

Available Colours / Colores Disponibles

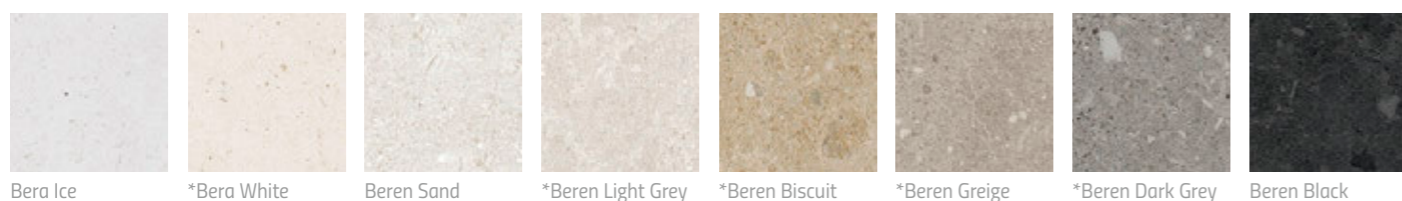

*20mm. Thickness Available Colour
*Color Disponible en 20mm.

Available Sizes / Formatos Disponibles

Step Tile & Countertops Available. Consult Special Pieces Section.
Peldaños y Encimeras disponibles. Consulte la Sección de Piezas Especiales.

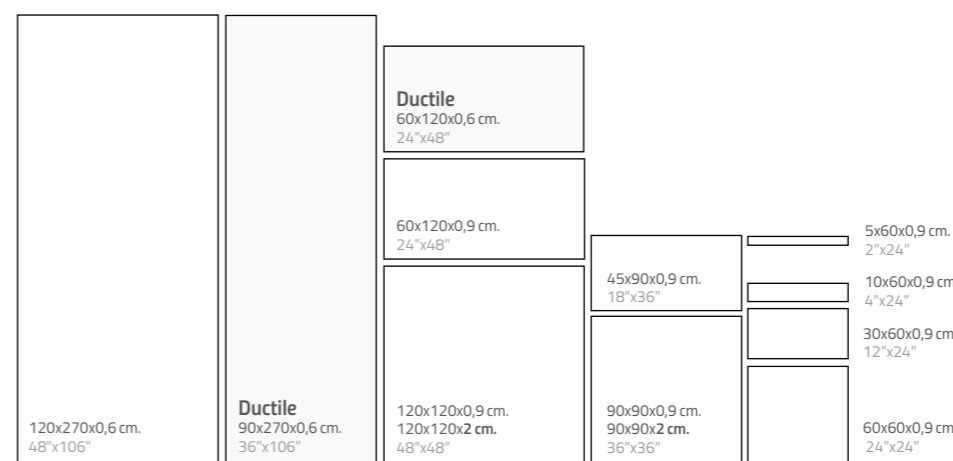

Complements / Complementos

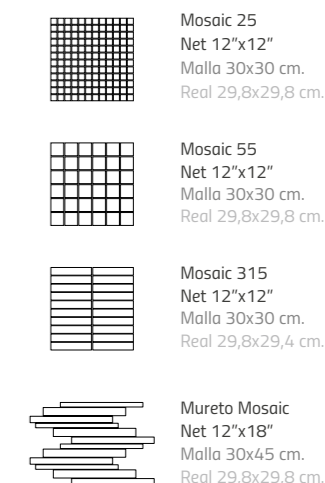

Ductile Wall Tiles Available Sizes & Finishes / Formatos y Acabados Disponibles en Revestimientos Ductile

Nominal Size Formato Nominal	Real Size Formato Real	Natural	Soft Textured	Price Code	Pz/Box	M2/Box	Kg/Box	Box/Pa	M2/Pa	Kg/Pa
Ductile 60x120 cm. 24"x48"	59,8x119,8x0,6 cm.	●	●	620	3	2,15	25,80	24	51,48	649
Ductile 90x270 cm. 36"x106"	89,8x269,8x0,6 cm.	●		970	1	2,42	29,04	24	58,08	801

Porcelain Tiles Available Sizes & Finishes / Formatos y Acabados Disponibles en Porcelánico

Nominal Size Formato Nominal	Real Size Formato Real	Honed	Natural C1 · R9 · CA	Soft Textured C2 · R10 · CB	B. Hammered C2 · R10 · CB	Anti-Slip C3 · R11 · CC	Price Code	Pz/Box	M2/Box	Kg/Box	Box/Pa	M2/Pa	Kg/Pa
5x60 cm. 2"x24"	4,8x59,8x0,9 cm.		●		●	●	5	20	0,57	13,20	60	34,44	832
10x60 cm. 4"x24"	9,8x59,8x0,9 cm.		●		●	●	10	10	0,59	13,30	60	35,40	838
30x60 cm. 12"x24"	29,8x59,8x0,9 cm.		●		●	●	30	6	1,07	22,00	48	51,36	1094
60x60 cm. 24"x24"	59,8x59,8x0,9 cm.		●		●	●	60	3	1,07	23,22	40	42,91	962
45x90 cm. 18"x36"	44,8x89,8x0,9 cm.		●		●	●	45	3	1,21	25,50	32	38,62	849
90x90 cm. 36"x36"	89,8x89,8x0,9 cm.	●	●	●	●	●	90	2	1,61	34,00	24	38,71	846
*90x90x2 cm. 36"x36"	89,8x89,8x2 cm.					●	94	1	0,81	37,09	24	19,35	946
60x120 cm. 24"x48"	59,8x119,8x0,9 cm.	●	●	●	●	●	62	2	1,43	30,32	24	34,32	767
120x120 cm. 48"x48"	119,8x119,8x0,9 cm.	●	●	●	●	●	120	1	1,44	30,50	40	57,41	1265
*120x120x2 cm. 48"x48"	119,8x119,8x2 cm.					●	121	1	1,44	66,02	16	22,96	1140
120x270 cm. 48"x106"	119,8x269,8x0,6 cm.	●	●	●			276	1	3,23	45,50	24	77,52	1250
Mosaic 25	29,8x29,8x0,9 cm.		●		●	●	25	5	0,44	9,00	60	26,40	576
Mosaic 55	29,8x29,8x0,9 cm.		●		●	●	55	5	0,44	9,00	60	26,40	576
Mosaic 315	29,8x29,4x0,9 cm.		●		●	●	315	5	0,44	9,00	60	26,40	576
Mureto Mosaic	29,8x29,8x0,9 cm.		●		●	●	300	5	0,44	9,00	40	17,60	395



Beren Light Grey
Dot Relief
Graphic Scale 1/4



Beren Light Grey
Saw Relief
Graphic Scale 1/4



Beren Light Grey
Six Relief
Graphic Scale 1/4

Rectified / Destonified V.2 / Rectificado / Destonificado V.2
N° Designs By Format / N° De Diseños Por Formato : D-30X90: 16

Available Colours / Colores Disponibles



Bera White Beren Light Grey Beren Biscuit Beren Dark Grey

Ductile Reliefs

Ductile Wall Tiles · Revestimientos Ductile

Available Sizes / Formatos Disponibles

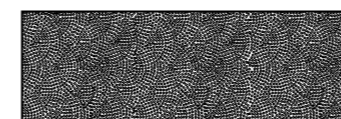

DOT
Ductile
30x90x0,9 cm.
12"x36"

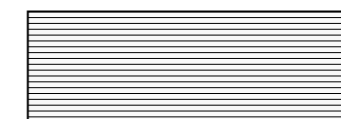

SAW
Ductile
30x90x0,9 cm.
12"x36"

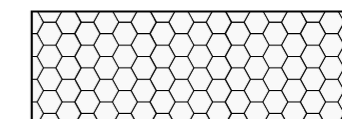

SIX
Ductile
30x90x0,9 cm.
12"x36"

Wall Tiles Available Sizes & Finishes / Formatos y Acabados Disponibles en Revestimientos Cerámicos

Nominal Size Formato Nominal	Real Size Formato Real	Dot	Saw	Six	Price Code	Pz/Box	M2/Box	Kg/Box	Box/Pa	M2/Pa	Kg/Pa
Ductile Relief 30x90 cm. 12"x36"	29,8x89,8x0,9 cm.	●	●	●	320	4	1,07	17,60	48	51,36	870

Blanc

White Marble Stone in Ceramics
Mármol Blanco en Cerámica



Soft Textured Finish

3D-Fit®
Technology

Color Body Porcelain & Ductile / Porcelánico Masa Coloreada y Ductile
Rectified / Destonified V.2 / Rectificado / Destonificado V.2
N° Designs By Format / N° De Diseños Por Formato :
120x270: 7 / D-90x270: 7 / D-60x120: 14-24 / 120x120: 14 / 60x120: 14-24 / 90x90: 16 / 45x90: 32

Blanc Statuario Gold
Soft Textured Finish
Escala 1/4

Available Sizes / Formatos Disponibles

Step Tile & Countertops Availables. Consult Special Pieces Section.
Peldaños y Encimeras disponibles. Consulte la Sección de Piezas Especiales.

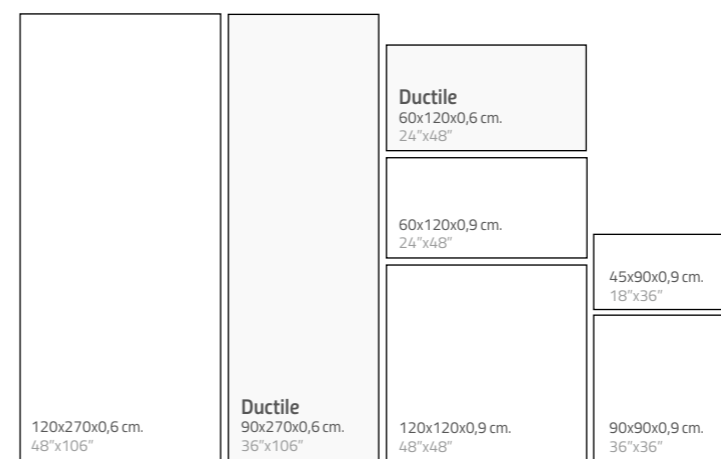

Complements / Complementos

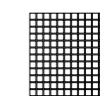

Mosaic 25
Net 12"x12"
Malla 30x30 cm.
Real 29,8x29,8 cm.

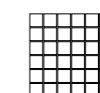

Mosaic 55
Net 12"x12"
Malla 30x30 cm.
Real 29,8x29,8 cm.

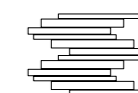

Mureto Mosaic
Net 12"x18"
Malla 30x45 cm.
Real 29,8x29,8 cm.

Ductile Wall Tiles Available Sizes & Finishes / Formatos y Acabados Disponibles en Revestimientos Ductile

Nominal Size Formato Nominal	Real Size Formato Real	Soft Textured	Price Code	Pz/Box	M2/Box	Kg/Box	Box/Pa	M2/Pa	Kg/Pa
Ductile 60x120 cm. 24"x48"	59,8x119,8x0,6 cm.	●	620	3	2,15	25,80	24	51,48	649
Ductile 90x270 cm. 36"x106"	89,8x269,8x0,6 cm.	●	970	1	2,42	29,04	24	58,08	801

Porcelain Tiles Available Sizes & Finishes / Formatos y Acabados Disponibles en Porcelánico

Nominal Size Formato Nominal	Real Size Formato Real	Soft Textured C1 · R9 · CA	Price Code	Pz/Box	M2/Box	Kg/Box	Box/Pa	M2/Pa	Kg/Pa
45x90 cm. 18"x36"	44,8x89,8x0,9 cm.	●	45	3	1,21	25,50	30	36,21	832
90x90 cm. 36"x36"	89,8x89,8x0,9 cm.	●	90	2	1,61	34,00	24	38,71	846
60x120 cm. 24"x48"	59,8x119,8x0,9 cm.	●	62	2	1,43	30,32	24	34,32	728
120x120 cm. 48"x48"	119,8x119,8x0,9 cm.	●	120	1	1,44	30,50	40	57,41	1265
120x270 cm. 48"x106"	119,8x269,8x0,6 cm.	●	276	1	3,23	45,50	24	77,52	1250
Mosaic 25	29,8x29,8x0,9 cm.	●	25	5	0,44	9,02	60	26,40	565
Mosaic 55	29,8x29,8x0,9 cm.	●	55	5	0,44	9,02	60	26,40	565
Mureto Mosaic	29,8x29,8x0,9 cm.	●	300	5	0,44	8,94	40	17,60	382

Available Colours / Colores Disponibles



Blanc Calacatta



Blanc Calacatta Gold



Blanc Statuario Gold



Blanc Invisible

Ductile Reliefs

Our white marble-inspired collections now feature wall tiles with relief options. Maintaining elegance, Blanc will be available in two types of relief: Code, with thin parallel lines at various distances from each other. And Cane, which presents fine spherical grooves of different sizes. Two soft rhythm options that further enrich the graphics of our marble series.

Nuestras colecciones inspiradas en el mármol blanco presentan ahora opciones de revestimiento en relieve. Manteniendo la elegancia, Blanc estará disponible en dos tipos de relieve: Code, con finas líneas paralelas a diversas distancias unas de otras. Y Cane, que presenta finas ranuras esféricas de tamaños diferentes. Dos opciones de ritmo suave que enriquecen más si cabe la gráfica de nuestra serie marmórea.

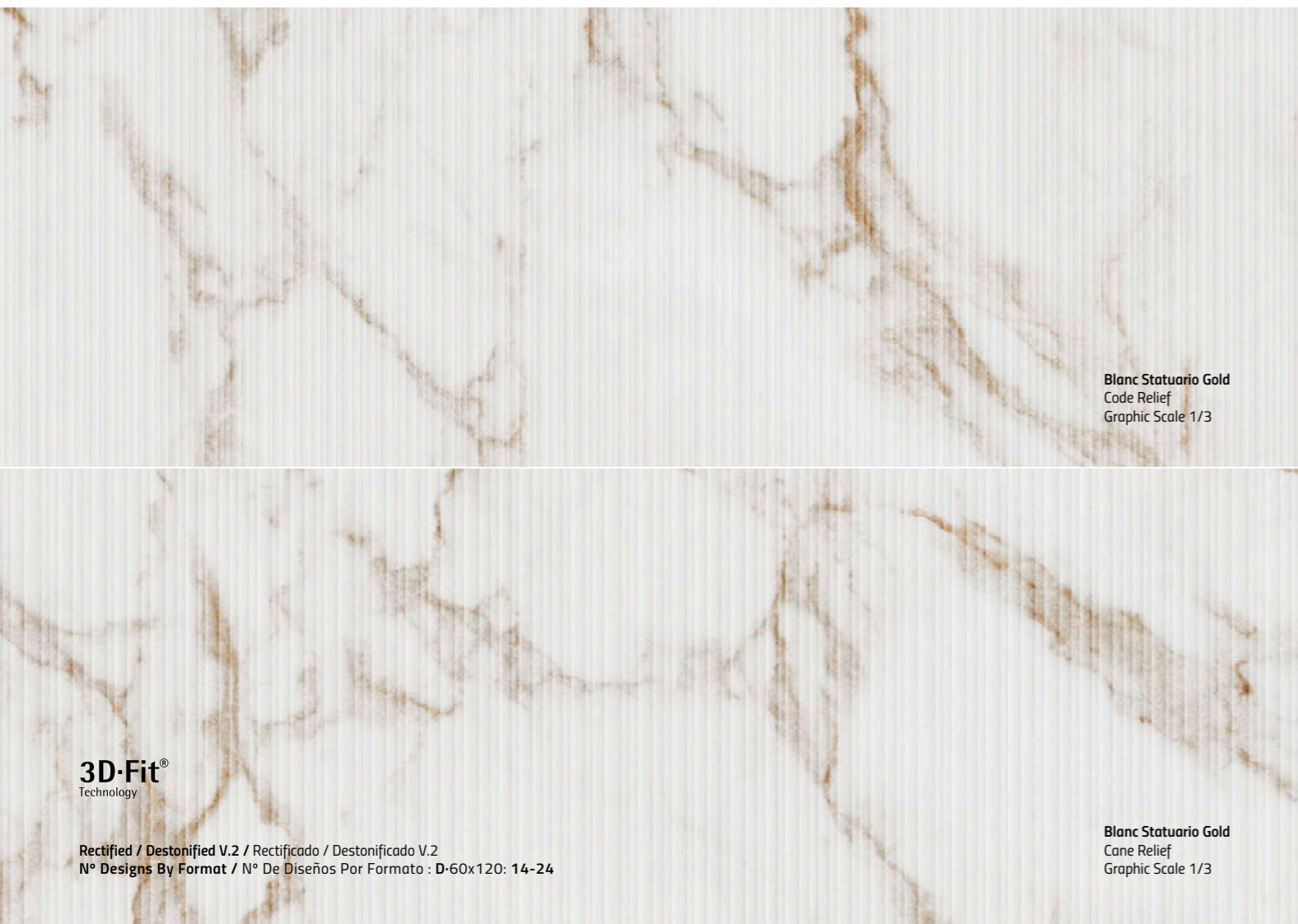

Ductile Reliefs

Ductile Wall Tiles · Revestimientos Ductile

Available Sizes / Formatos Disponibles

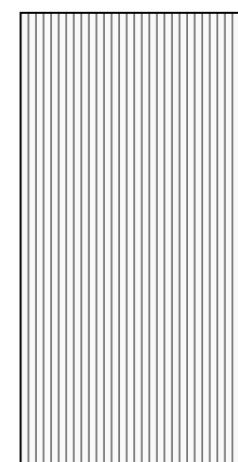

CODE
Ductile
60x120x0,9 cm.
24"x48"

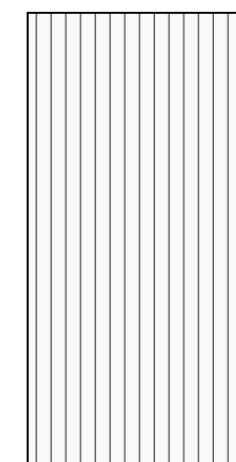

CANE
Ductile
60x120x0,9 cm.
24"x48"

Available Colours / Colores Disponibles



Blanc Calacatta Blanc Calacatta Gold Blanc Statuario Gold Blanc Invisible

Wall Tiles Available Sizes & Finishes / Formatos y Acabados Disponibles en Revestimientos Cerámicos

Nominal Size Formato Nominal	Real Size Formato Real	Code	Cane	Price Code	Pz/Box	M2/Box	Kg/Box	Box/Pa	M2/Pa	Kg/Pa
Ductile Relief 60x120 cm. 24"x48"	59,8x119,8x0,9 cm.	•	•	620	2	1,43	22,00	24	34,32	558

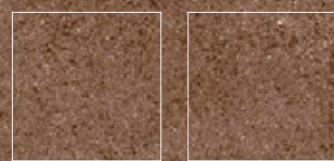

Soft Textured Finish Anti-slip Finish

3D-Fit[®]
Technology

Color Body Porcelain & Ductile / Porcelánico Masa Coloreada y Ductile
Rectified / Destonified V.2 / Rectificado / Destonificado V.2
N° Designs By Format / N° De Diseños Por Formato :
120x270: 7 / D-90x270: 7 / D-60x120: 24 / 120x120: 14 / 60x120: 24 / 90x90: 16 / 45x90: 32 / 60x60: 48 / 30x60: 96

Cuit Terra
Soft Textured Finish
Escala 1/3

Available Sizes / Formatos Disponibles

Step Tile & Countertops Available. Consult Special Pieces Section.
Peldaños y Encimeras disponibles. Consulte la Sección de Piezas Especiales.

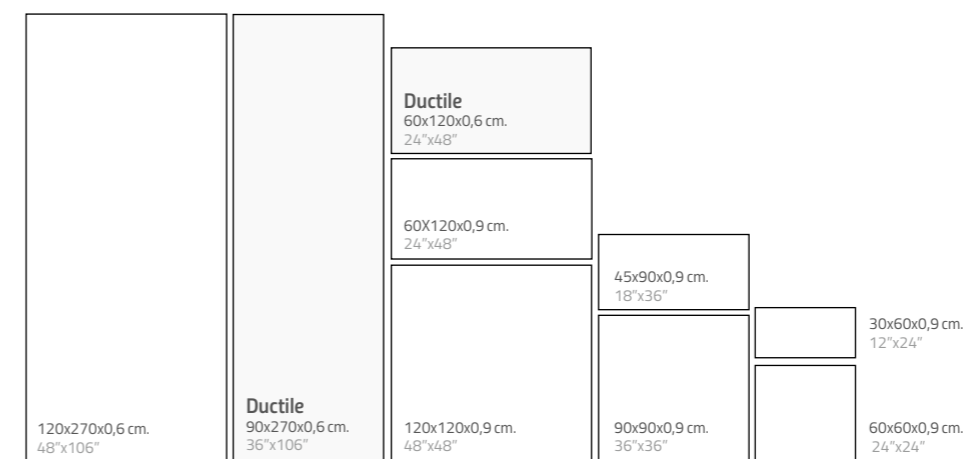

Complements / Complementos

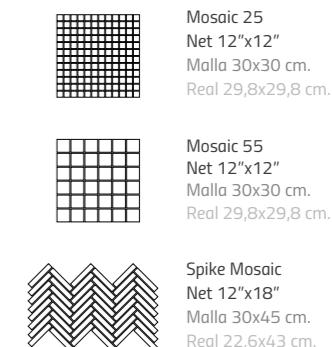

Ductile Wall Tiles Available Sizes & Finishes / Formatos y Acabados Disponibles en Revestimientos Ductile

Nominal Size Formato Nominal	Real Size Formato Real	Soft Textured	Price Code	Pz/Box	M2/Box	Kg/Box	Box/Pa	M2/Pa	Kg/Pa
Ductile 60x120 cm. 24"x48"	59,8x119,8x0,6 cm.	●	620	3	2,15	25,80	24	51,48	649
Ductile 90x270 cm. 36"x106"	89,8x269,8x0,6 cm.	●	970	1	2,42	29,04	24	58,08	801

Porcelain Tiles Available Sizes & Finishes / Formatos y Acabados Disponibles en Porcelánico

Nominal Size Formato Nominal	Real Size Formato Real	Soft Textured C2 · R10 · CB	Anti-Slip C3 · R11 · CC	Price Code	Pz/Box	M2/Box	Kg/Box	Box/Pa	M2/Pa	Kg/Pa
30x60 cm. 12"x24"	29,8x59,8x0,9 cm.	●	●	30	6	1,07	22,00	48	51,36	1094
60x60 cm. 24"x24"	59,8x59,8x0,9 cm.	●	●	60	3	1,07	23,22	40	42,91	962
45x90 cm. 18"x36"	44,8x89,8x0,9 cm.	●	●	45	3	1,21	25,50	32	38,62	849
90x90 cm. 36"x36"	89,8x89,8x0,9 cm.	●	●	90	2	1,61	34,00	24	38,71	846
60x120 cm. 24"x48"	59,8x119,8x0,9 cm.	●	●	62	2	1,43	30,32	24	34,32	767
120x120 cm. 48"x48"	119,8x119,8x0,9 cm.	●	●	120	1	1,44	30,50	40	57,41	1265
120x270 cm. 48"x106"	119,8x269,8x0,6 cm.	●	●	276	1	3,23	45,50	24	77,52	1250
Mosaic 25	29,8x29,8x0,9 cm.	●	●	25	5	0,44	9,00	60	26,40	576
Mosaic 55	29,8x29,8x0,9 cm.	●	●	55	5	0,44	9,00	60	26,40	576
Spike Mosaic	22,6x43	●	●	303	5	0,47	10,75	40	18,80	465

Available Colours / Colores Disponibles



Cuit Bone Cuit Grey Cuit Clay Cuit Terra Cuit Charcoal

Ductile Reliefs

Livingceramics presents a new wall relief for Cuit. The Series inspired by the most contemporary version of terracotta has two bases of material and handcrafted aesthetics: Reed, with small parallel concave lines with irregular edges. And Ribbed, with wider convex lines. Two reliefs that appeal to the raw material as a key element and that match perfectly with our new series, with an aesthetic that is both artisanal and timeless at the same time.

Livingceramics presenta un nuevo revestimientos en relieve para Cuit. La Serie inspirada en la versión más contemporánea de la terracota cuenta con dos bases de estética matérica y artesanal: Reed, con pequeñas líneas cóncavas paralelas de cantos irregulares. Y Ribbed, de líneas convexas más amplias. Dos relieves que apelan a la materia prima como elemento clave y que casan a la perfección con nuestra nueva serie, de estética artesanal y atemporal al mismo tiempo.

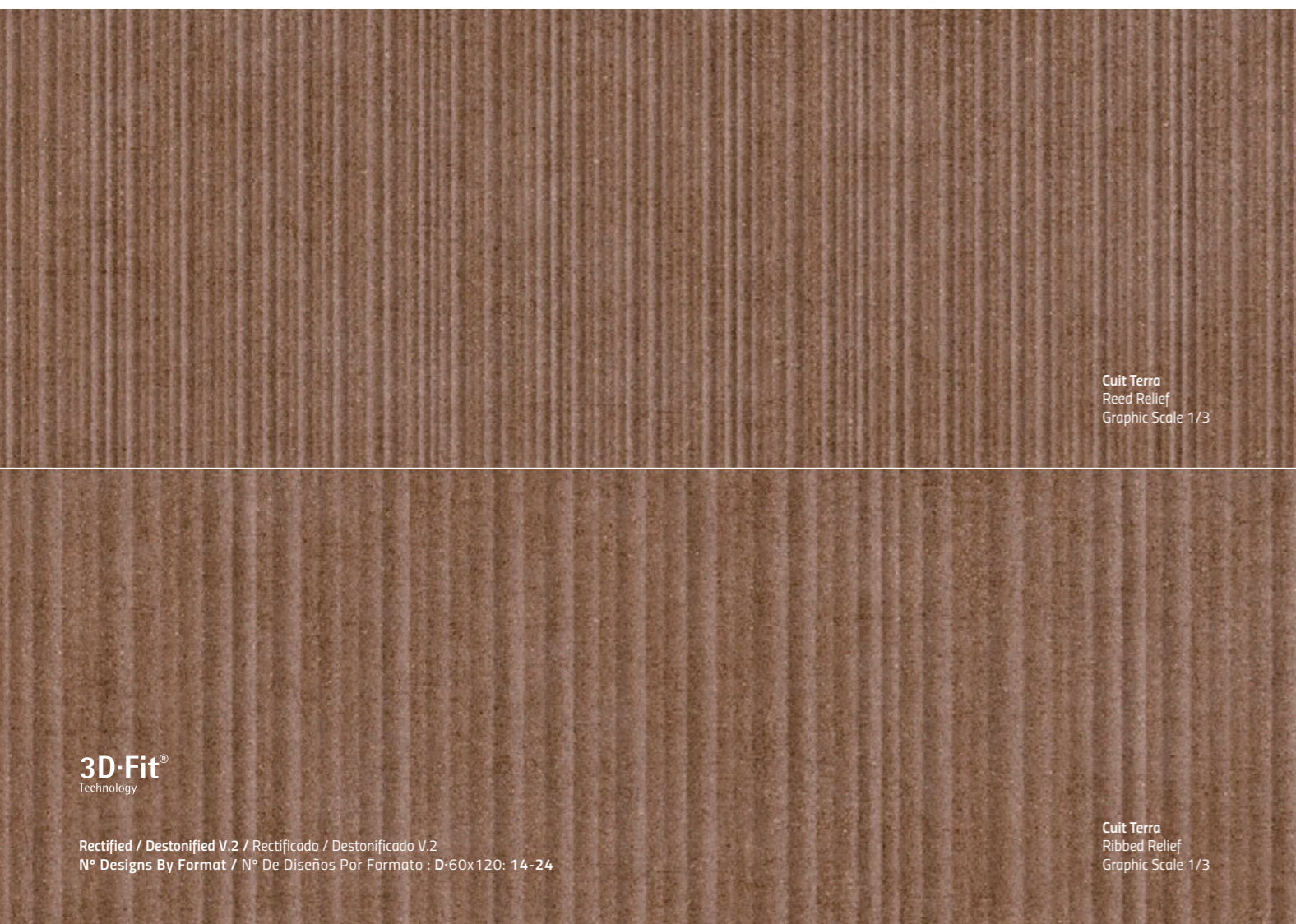

Cuit Terra
Reed Relief
Graphic Scale 1/3

Cuit Terra
Ribbed Relief
Graphic Scale 1/3

3D-Fit®
Technology

Rectified / Destonified V.2 / Rectificado / Destonificado V.2
Nº Designs By Format / Nº De Diseños Por Formato : D-60x120: 14-24

Ductile Reliefs

Ductile Wall Tiles · Revestimientos Ductile

Available Sizes / Formatos Disponibles

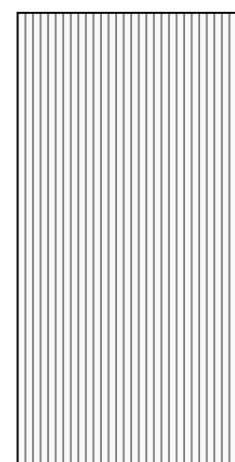

REED
Ductile
60x120x0,9 cm.
24"x48"

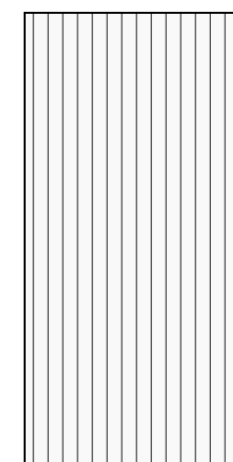

RIBBED
Ductile
60x120x0,9 cm.
24"x48"

Available Colours / Colores Disponibles

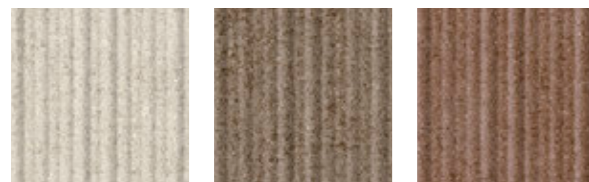

Cuit Bone

Cuit Clay

Cuit Terra

Wall Tiles Available Sizes & Finishes / Formatos y Acabados Disponibles en Revestimientos Cerámicos

Nominal Size Formato Nominal	Real Size Formato Real	Reed	Ribbed	Price Code	Pz/Box	M2/Box	Kg/Box	Box/Pa	M2/Pa	Kg/Pa
Ductile Relief 60x120 cm. 24"x48"	59,8x119,8x0,9 cm.	●	●	620	2	1,43	22,00	24	34,32	558

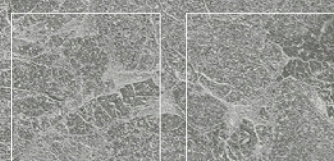
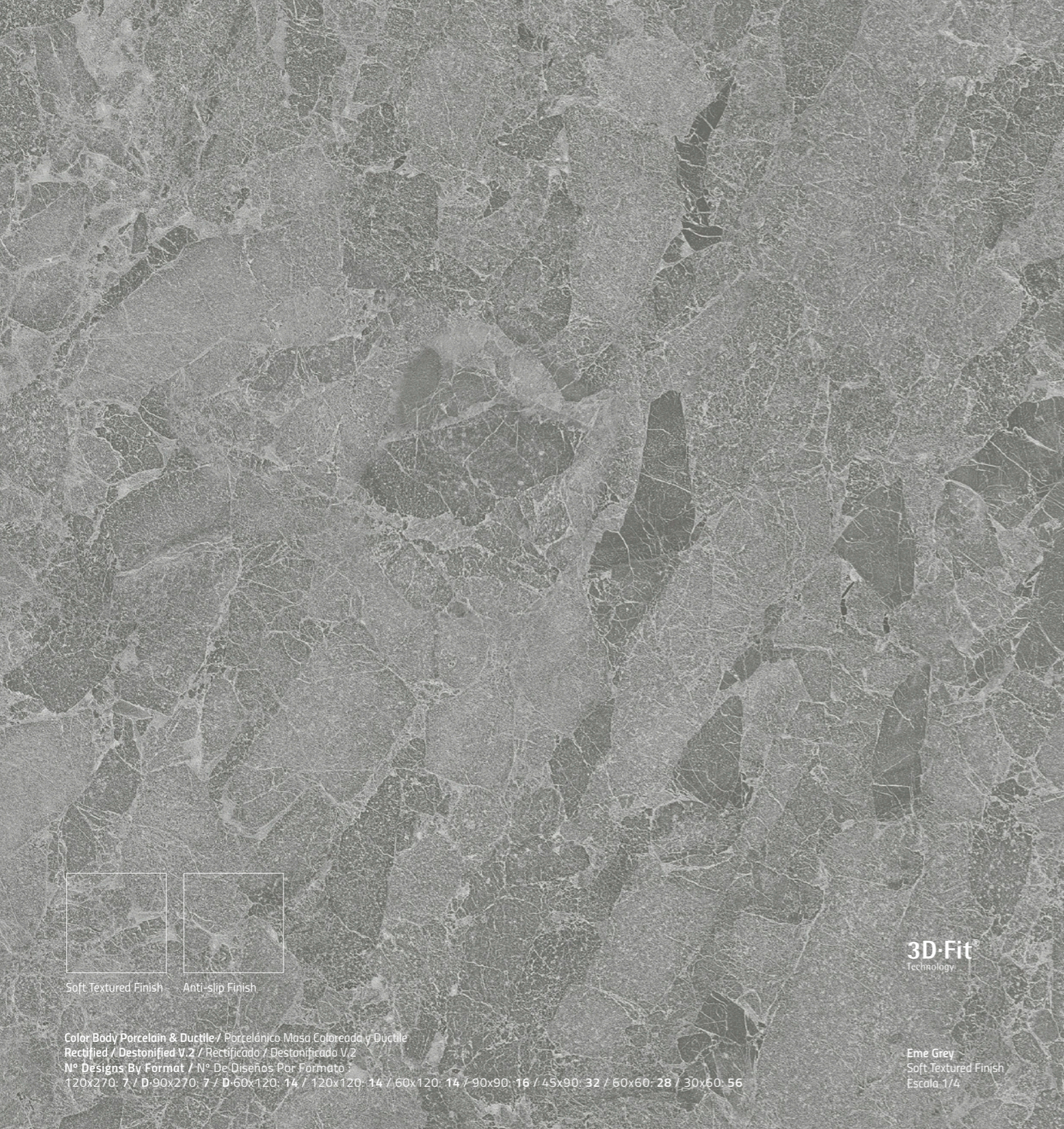

Soft Textured Finish Anti-slip Finish

Color Body Porcelain & Ductile / Porcelánico Masa Coloreada y Ductile
Rectified / Destonified V.2 / Rectificado / Destonificado V.2
N° Designs By Format / N° De Diseños Por Formato:
120x270: 7 / D-90x270: 7 / D-60x120: 14 / 120x120: 14 / 60x120: 14 / 90x90: 16 / 45x90: 32 / 60x60: 28 / 30x60: 56

3D-Fit
Technology

Eme Grey
Soft Textured Finish
Escala: 1/4

Available Colours:

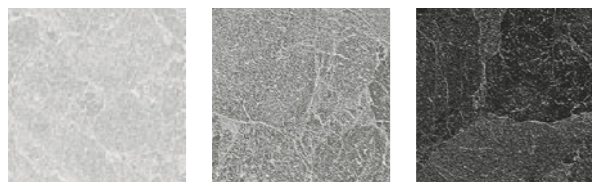

Eme Light Grey *Eme Grey Eme Anthracite

*20mm. Thickness Available Colour
*Color Disponible en 20mm.

Available Sizes / Formatos Disponibles

Step Tile & Countertops Available. Consult Special Pieces Section.
Peldaños y Encimeras disponibles. Consulte la Sección de Piezas Especiales.

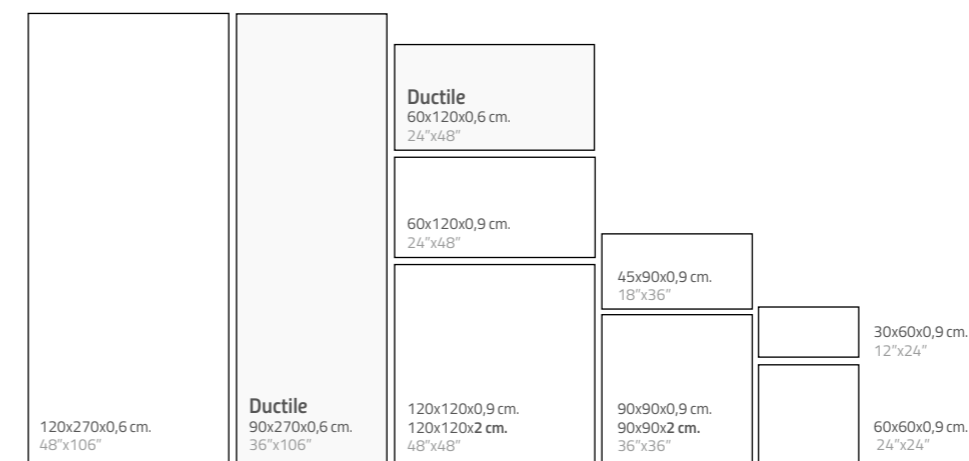

Complements / Complementos



Ductile Wall Tiles Available Sizes & Finishes / Formatos y Acabados Disponibles en Revestimientos Ductile

Nominal Size Formato Nominal	Real Size Formato Real	Soft Textured	Price Code	Pz/Box	M2/Box	Kg/Box	Box/Pa	M2/Pa	Kg/Pa
Ductile 60x120 cm. 24"x48"	59,8x119,8x0,6 cm.	●	620	3	2,15	25,80	24	51,48	649
Ductile 90x270 cm. 36"x106"	89,8x269,8x0,6 cm.	●	970	1	2,42	29,04	24	58,08	801

Porcelain Tiles Available Sizes & Finishes / Formatos y Acabados Disponibles en Porcelánico

Nominal Size Formato Nominal	Real Size Formato Real	Soft Textured C1 · R9 · CA	Anti-Slip C3 · R11 · CC	Price Code	Pz/Box	M2/Box	Kg/Box	Box/Pa	M2/Pa	Kg/Pa
30x60 cm. 12"x24"	29,8x59,8x0,9 cm.	●	●	30	6	1,07	22,00	48	51,36	1094
60x60 cm. 24"x24"	59,8x59,8x0,9 cm.	●	●	60	3	1,07	23,22	40	42,91	962
45x90 cm. 18"x36"	44,8x89,8x0,9 cm.	●	●	45	3	1,21	25,50	32	38,62	849
90x90 cm. 36"x36"	89,8x89,8x0,9 cm.	●	●	90	2	1,61	34,00	24	38,71	846
*90x90x2 cm. 36"x36"	89,8x89,8x2 cm.	●	●	94	1	0,81	37,09	24	19,35	946
60x120 cm. 24"x48"	59,8x119,8x0,9 cm.	●	●	62	2	1,43	30,32	24	34,32	767
120x120 cm. 48"x48"	119,8x119,8x0,9 cm.	●	●	120	1	1,44	30,50	40	57,41	1265
*120x120x2 cm. 48"x48"	119,8x119,8x2 cm.	●	●	121	1	1,44	66,02	16	22,96	1140
120x270 cm. 48"x106"	119,8x269,8x0,6 cm.	●	●	276	1	3,23	45,50	24	77,52	1250
Mosaic 25	29,8x29,8x0,9 cm.	●	●	25	5	0,44	9,00	60	26,40	576
Mosaic 55	29,8x29,8x0,9 cm.	●	●	55	5	0,44	9,00	60	26,40	576
Mureto Mosaic	29,8x29,8x0,9 cm.	●	●	300	5	0,44	9,00	40	17,60	395

Ductile Reliefs

Eme is a daring and contemporary collection at the same time. This series presents a marked tone-on-tone stone shade variation, which is enriched thanks to the original reliefs designed for this Ductile wall tile. Both options offer movement by combining the richness of the graphics with the variety of relief lines. 3D-Fit digital printing technology enhance the power of this collection.

Eme es una colección atrevida y contemporánea a la vez. Esta serie presenta un marcado destonificado pétreo tono sobre tono, que se enriquece gracias a los originales relieves pensados para este revestimiento en Ductile: Jazz y Jump. Ambas opciones ofrecen movimiento al combinar la riqueza de la gráfica con la variedad de líneas del relieve. La tecnología de impresión digital 3D-Fit acaba de potenciar la fuerza de esta colección.

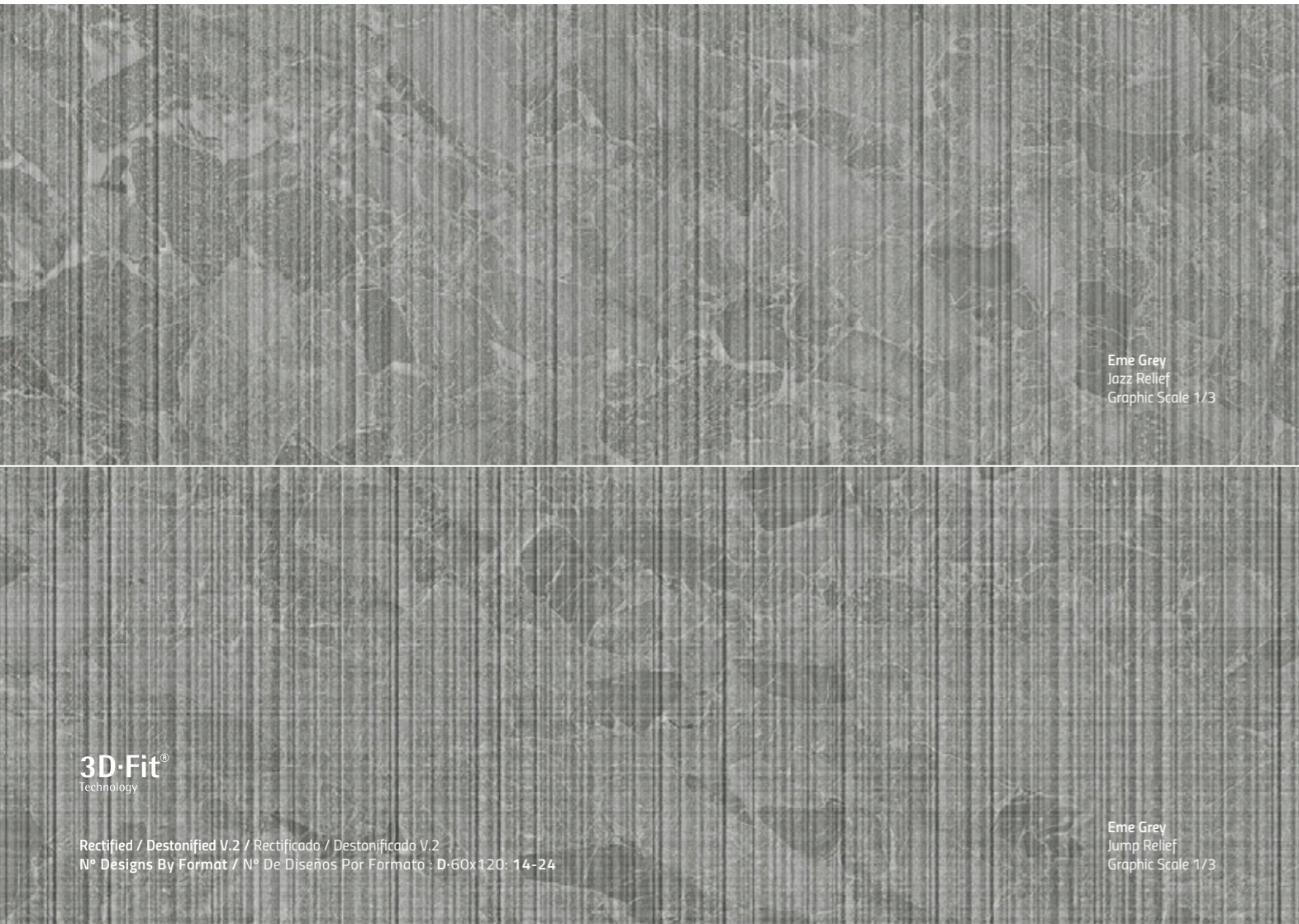

Eme Grey
Jazz Relief
Graphic Scale 1/3

Eme Grey
Jump Relief
Graphic Scale 1/3

3D-Fit®
Technology

Rectified / Destonified V.2 / Rectificado / Destonificado V.2
Nº Designs By Format / Nº De Diseños Por Formato : D-60x120: 14-24

Available Colours:



Eme Light Grey

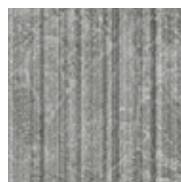

Eme Grey

Ductile Reliefs

Ductile Wall Tiles · Revestimientos Ductile

Available Sizes / Formatos Disponibles

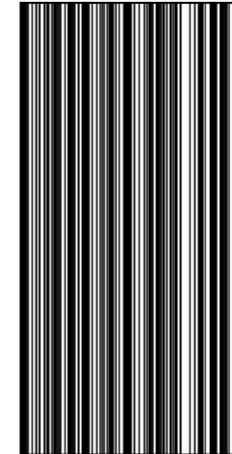

JAZZ
Ductile
60x120x0,9 cm.
24"x48"

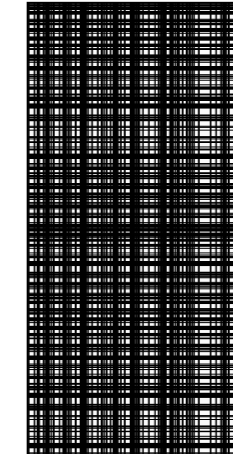

JUMP
Ductile
60x120x0,9 cm.
24"x48"

Wall Tiles Available Sizes & Finishes / Formatos y Acabados Disponibles en Revestimientos Cerámicos

Nominal Size Formato Nominal	Real Size Formato Real	Jazz	Jump	Price Code	Pz/Box	M2/Box	Kg/Box	Box/Pa	M2/Pa	Kg/Pa
Ductile Relief 60x120 cm. 24"x48"	59,8x119,8x0,9 cm.	●	●	620	2	1,43	22,00	24	34,32	558



Natural Finish Anti-slip Finish

Color Body Porcelain / Porcelánico Masa Coloreada
Rectified / Destonified V.3 / Rectificado / Destonificado V.3
N° Designs By Format / N° De Diseños Por Formato :
120x270: 7 / D-90x270: 7 / D-60x120: 14 / 120x120: 14 / 60x120: 14 / 90x90: 16 / 45x90: 32 / 60x60: 28 / 30x60: 56 / 10x60: 168

Floss Silver
Natural Finish
Escala 1/4

Available Colours / Colores Disponibles



Floss Bone Floss Silver Floss Smoky Floss Graphite

Available Sizes / Formatos Disponibles

Step Tile & Countertops Availables. Consult Special Pieces Section.
Peldaños y Encimeras disponibles. Consulte la Sección de Piezas Especiales.

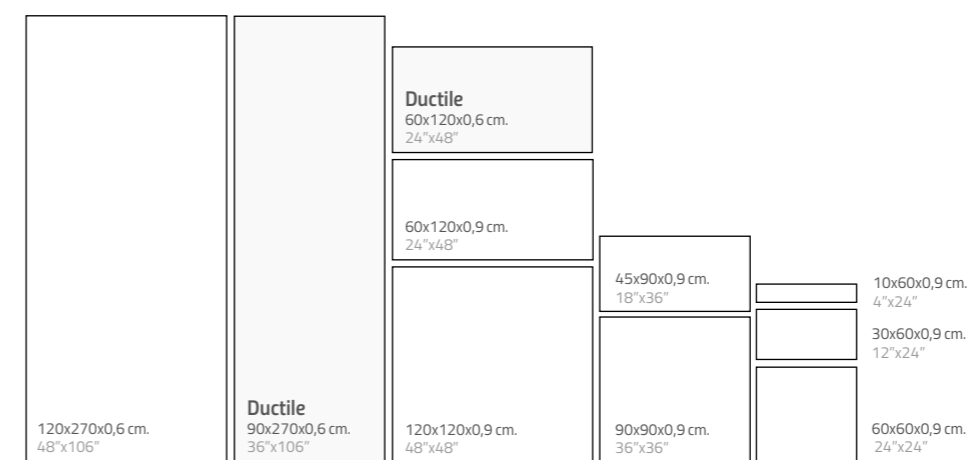

Complements / Complementos

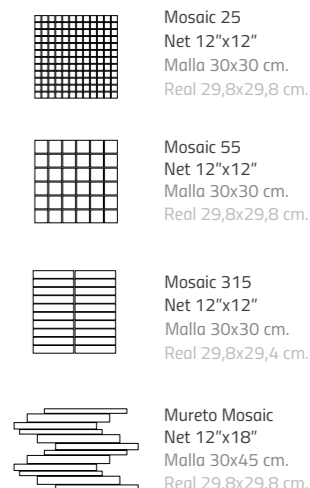

Ductile Wall Tiles Available Sizes & Finishes / Formatos y Acabados Disponibles en Revestimientos Ductile

Nominal Size Formato Nominal	Real Size Formato Real	Natural	Price Code	Pz/Box	M2/Box	Kg/Box	Box/Pa	M2/Pa	Kg/Pa
Ductile 60x120 cm. 24"x48"	59,8x119,8x0,6 cm.	●	620	3	2,15	25,80	24	51,48	649
Ductile 90x270 cm. 36"x106"	89,8x269,8x0,6 cm.	●	970	1	2,42	29,04	24	58,08	801

Porcelain Tiles Available Sizes & Finishes / Formatos y Acabados Disponibles en Porcelánico

Nominal Size Formato Nominal	Real Size Formato Real	Natural C1 · R9 · CA	Anti-Slip C3 · R11 · CC	Price Code	Pz/Box	M2/Box	Kg/Box	Box/Pa	M2/Pa	Kg/Pa
10x60 cm. 4"x24"	9,8x59,8x0,9 cm.	●	●	10	10	0,59	13,30	60	35,40	838
30x60 cm. 12"x24"	29,8x59,8x0,9 cm.	●	●	30	6	1,07	22,00	48	51,36	1094
60x60 cm. 24"x24"	59,8x59,8x0,9 cm.	●	●	60	3	1,07	23,22	40	42,91	962
45x90 cm. 18"x36"	44,8x89,8x0,9 cm.	●	●	45	3	1,21	25,50	32	38,62	849
90x90 cm. 36"x36"	89,8x89,8x0,9 cm.	●	●	90	2	1,61	34,00	24	38,71	846
60x120 cm. 24"x48"	59,8x119,8x0,9 cm.	●	●	62	2	1,43	30,32	24	34,32	767
120x120 cm. 48"x48"	119,8x119,8x0,9 cm.	●	●	120	1	1,44	30,50	40	57,41	1265
120x270 cm. 48"x106"	119,8x269,8x0,6 cm.	●	●	276	1	3,23	45,50	24	77,52	1250
Mosaic 25	29,8x29,8x0,9 cm.	●	●	25	5	0,44	9,00	60	26,40	576
Mosaic 55	29,8x29,8x0,9 cm.	●	●	55	5	0,44	9,00	60	26,40	576
Mosaic 315	29,8x29,4x0,9 cm.	●	●	315	5	0,44	9,00	60	26,40	576
Mureto Mosaic	29,8x29,8x0,9 cm.	●	●	300	5	0,44	9,00	40	17,60	395



Ground Grey
Brush Relief
Graphic Scale 1/4



Ground Grey
Tip Relief
Graphic Scale 1/4



Ground Grey
Twist Relief
Graphic Scale 1/4

Rectified / Destonified V.1 / Rectificado / Destonificado V.1
N° Designs By Format / N° De Diseños Por Formato : D-30X90: 16

Ductile Reliefs

Ductile Wall Tiles · Revestimientos Ductile

Available Sizes / Formatos Disponibles

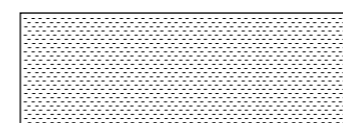

BRUSH
Ductile
30x90x0,9 cm.
12"x36"

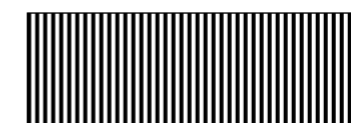

TIP
Ductile
30x90x0,9 cm.
12"x36"



TWIST
Ductile
30x90x0,9 cm.
12"x36"

Available Colours / Colores Disponibles



Ground Light

Ground Cream

Ground Grey

Wall Tiles Available Sizes & Finishes / Formatos y Acabados Disponibles en Revestimientos Cerámicos

Nominal Size Formato Nominal	Real Size Formato Real	Brush	Tip	Twist	Price Code	Pz/Box	M2/Box	Kg/Box	Box/Pa	M2/Pa	Kg/Pa
Ductile Relief 30x90 cm. 12"x36"	29,8x89,8x0,9 cm.	●	●	●	320	4	1,07	17,60	48	51,36	870



Natural Finish Anti-slip Finish

Color Body Porcelain & Ductile / Porcelánico Masa Coloreada y Ductile
Rectified / Destonified V.2 / Rectificado / Destonificado V.2
N° Designs By Format / N° De Diseños Por Formato :
120x270: 7 / D-90x270: 7 / D-60x120: 14 / 120x120: 14 / 60x120: 14 / 90x90: 16 / 45x90: 32 / 60x60: 28 / 30x60: 56 / 10x60: 168

Gubi Cloud
Natural Finish
Escala 1/4

Available Colours / Colores Disponibles



*Gubi Light *Gubi Cloud Gubi Taupe Gubi Anthracite

*20mm. Thickness Available Colour
*Color Disponible en 20mm.

Available Sizes / Formatos Disponibles

Step Tile & Countertops Available. Consult Special Pieces Section.
Peldaños y Encimeras disponibles. Consulte la Sección de Piezas Especiales.

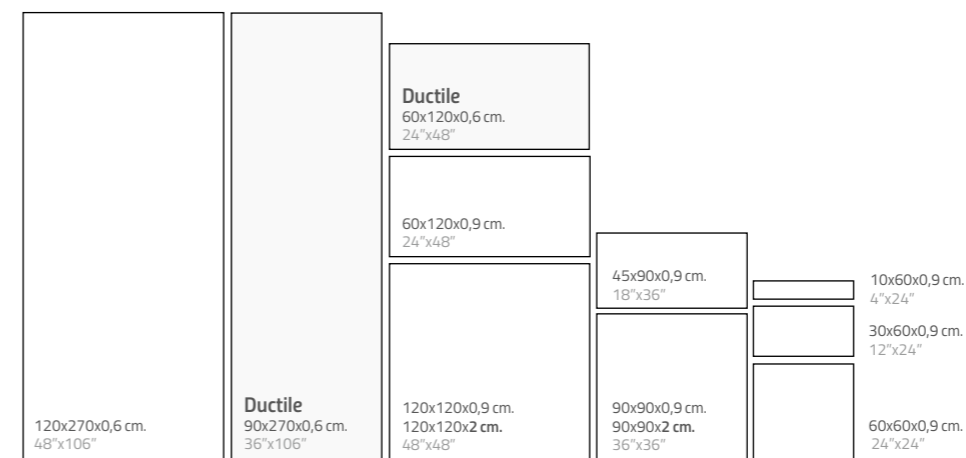

Complements / Complementos

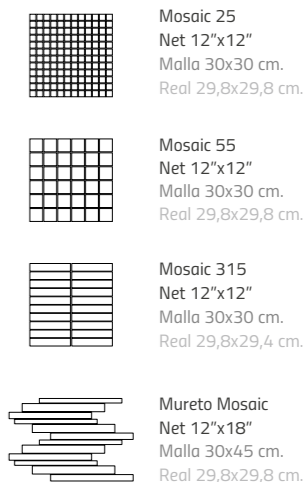

Ductile Wall Tiles Available Sizes & Finishes / Formatos y Acabados Disponibles en Revestimientos Ductile

Nominal Size Formato Nominal	Real Size Formato Real	Natural	Price Code	Pz/Box	M2/Box	Kg/Box	Box/Pa	M2/Pa	Kg/Pa
Ductile 60x120 cm. 24"x48"	59,8x119,8x0,6 cm.	●	620	3	2,15	25,80	24	51,48	649
Ductile 90x270 cm. 36"x106"	89,8x269,8x0,6 cm.	●	970	1	2,42	29,04	24	58,08	801

Porcelain Tiles Available Sizes & Finishes / Formatos y Acabados Disponibles en Porcelánico

Nominal Size Formato Nominal	Real Size Formato Real	Natural C1 · R9 · CA	Anti-Slip C3 · R11 · CC	Price Code	Pz/Box	M2/Box	Kg/Box	Box/Pa	M2/Pa	Kg/Pa
10x60 cm. 4"x24"	9,8x59,8x0,9 cm.	●	●	10	10	0,59	13,30	60	35,40	838
30x60 cm. 12"x24"	29,8x59,8x0,9 cm.	●	●	30	6	1,07	22,00	48	51,36	1094
60x60 cm. 24"x24"	59,8x59,8x0,9 cm.	●	●	60	3	1,07	23,22	40	42,91	962
45x90 cm. 18"x36"	44,8x89,8x0,9 cm.	●	●	45	3	1,21	25,50	32	38,62	849
90x90 cm. 36"x36"	89,8x89,8x0,9 cm.	●	●	90	2	1,61	34,00	24	38,71	846
*90x90x2 cm. 36"x36"	89,8x89,8x2 cm.	●	●	94	1	0,81	37,09	24	19,35	946
60x120 cm. 24"x48"	59,8x119,8x0,9 cm.	●	●	62	2	1,43	30,32	24	34,32	767
120x120 cm. 48"x48"	119,8x119,8x0,9 cm.	●	●	120	1	1,44	30,50	40	57,41	1265
*120x120x2 cm. 48"x48"	119,8x119,8x2 cm.	●	●	121	1	1,44	66,02	16	22,96	1140
120x270 cm. 48"x106"	119,8x269,8x0,6 cm.	●	●	276	1	3,23	45,50	24	77,52	1250
Mosaic 25	29,8x29,8x0,9 cm.	●	●	25	5	0,44	9,00	60	26,40	576
Mosaic 55	29,8x29,8x0,9 cm.	●	●	55	5	0,44	9,00	60	26,40	576
Mosaic 315	29,8x29,4x0,9 cm.	●	●	315	5	0,44	9,00	60	26,40	576
Mureto Mosaic	29,8x29,8x0,9 cm.	●	●	300	5	0,44	9,00	40	17,60	395



Gubi Cloud
Calm Relief
Graphic Scale 1/4

Gubi Cloud
Prints Relief
Graphic Scale 1/4

Rectified / Destonified V.2 / Rectificado / Destonificado V.2
Nº Designs By Format / Nº De Diseños Por Formato : D-30X90: 16

Gubi Cloud
Peak Relief
Graphic Scale 1/4

Ductile Reliefs

Ductile Wall Tiles · Revestimientos Ductile

Available Sizes / Formatos Disponibles



CALM
30x90x0,9 cm.
12"x36"



PRINTS
30x90x0,9 cm.
12"x36"

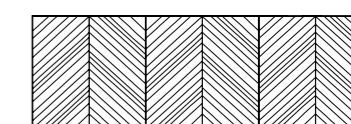

PEAK
30x90x0,9 cm.
12"x36"

Available Colours / Colores Disponibles



Gubi Light

Gubi Cloud

Gubi Taupe

Gubi Anthracite

Wall Tiles Available Sizes & Finishes / Formatos y Acabados Disponibles en Revestimientos Cerámicos

Nominal Size Formato Nominal	Real Size Formato Real	Calm	Prints	Peak	Price Code	Pz/Box	M2/Box	Kg/Box	Box/Pa	M2/Pa	Kg/Pa
Ductile Relief 30x90 cm. 12"x36"	29,8x89,8x0,9 cm.	●	●	●	320	4	1,07	17,60	48	51,36	870



Honed Finish Soft Textured Finish B.H. Finish B.H. Anti-Slip Finish

Color Body Porcelain & Ductile / Porcelánico Masa Coloreada y Ductile
Rectified / Destonified V.3 / Rectificado / Destonificado V.3
N° Designs By Format / N° De Diseños Por Formato :
120x270: 7 / D-90x270: 7 / D-60x120: 24 / 120x120: 14 / 60x120: 24 / 90x90: 16 / 45x90: 32 / 60x60: 48 / 30x60: 96

3D-Fit®
Technology

Kendo Ice
Soft Textured Finish
Escala 1/4

Available Colours / Colores Disponibles



Kendo Ice *Kendo Light *Kendo Classic

*20mm. Thickness Available Colour
*Color Disponible en 20mm.

Available Sizes / Formatos Disponibles

Step Tile & Countertops Availables. Consult Special Pieces Section.
Peldaños y Encimeras disponibles. Consulte la Sección de Piezas Especiales.

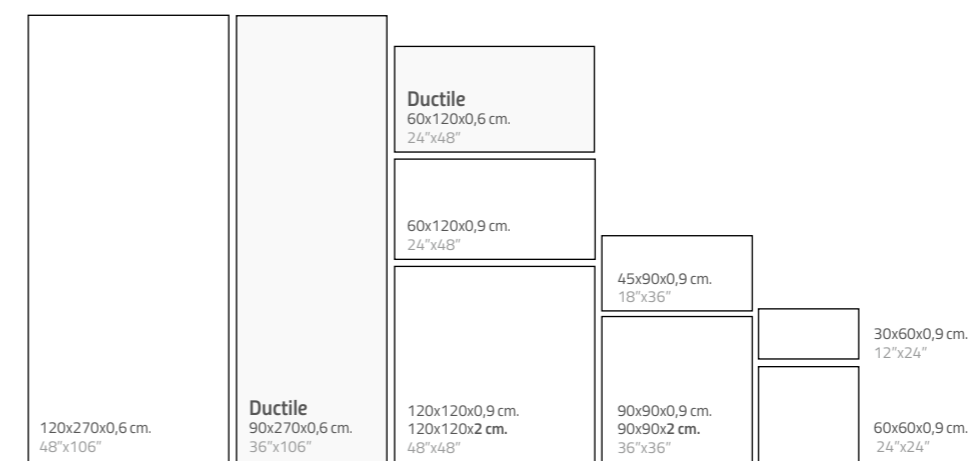

Complements / Complementos



Ductile Wall Tiles Available Sizes & Finishes / Formatos y Acabados Disponibles en Revestimientos Ductile

Nominal Size Formato Nominal	Real Size Formato Real	Soft Textured	Price Code	Pz/Box	M2/Box	Kg/Box	Box/Pa	M2/Pa	Kg/Pa
Ductile 60x120 cm. 24"x48"	59,8x119,8x0,6 cm.	●	620	3	2,15	25,80	24	51,48	649
Ductile 90x270 cm. 36"x106"	89,8x269,8x0,6 cm.	●	970	1	2,42	29,04	24	58,08	801

Porcelain Tiles Available Sizes & Finishes / Formatos y Acabados Disponibles en Porcelánico

Nominal Size Formato Nominal	Real Size Formato Real	Honed	Soft Textured C2 · R10 · CB	B.Hammered C2 · R10 · CB	B. H. Anti-Slip C3 · R11 · CC	Price Code	Pz/Box	M2/ Box	Kg/Box	Box/Pa	M2/Pa	Kg/Pa
30x60 cm. 12"x24"	29,8x59,8x0,9 cm.	●	●		●	30 / 30H	6	1,07	22,00	48	51,36	1094
60x60 cm. 24"x24"	59,8x59,8x0,9 cm.	●	●		●	60 / 60H	3	1,07	23,22	40	42,91	962
45x90 cm. 18"x36"	44,8x89,8x0,9 cm.	●	●		●	45 / 45H	3	1,21	25,50	32	38,62	849
90x90 cm. 36"x36"	89,8x89,8x0,9 cm.	●	●		●	90 / 90H	2	1,61	34,00	24	38,71	846
*90x90x2 cm. 36"x36"	89,8x89,8x2 cm.				●	94	1	0,81	37,09	24	19,35	946
60x120 cm. 24"x48"	59,8x119,8x0,9 cm.	●	●		●	62 / 62H	2	1,43	30,32	24	34,32	767
120x120 cm. 48"x48"	119,8x119,8x0,9 cm.	●	●		●	120 / 120H	1	1,44	30,50	40	57,41	1265
*120x120x2 cm. 48"x48"	119,8x119,8x2 cm.				●	121	1	1,44	66,02	16	22,96	1140
120x270 cm. 48"x106"	119,8x269,8x0,6 cm.	●	●	●		276 / 276H	1	3,23	45,50	24	77,52	1250
Mosaic 25	29,8x29,8x0,9 cm.	●	●		●	25 / 25H	5	0,44	9,00	60	26,40	576
Mosaic 55	29,8x29,8x0,9 cm.	●	●		●	55 / 55H	5	0,44	9,00	60	26,40	576
Mureto Mosaic	29,8x29,8x0,9 cm.	●	●		●	300 / 300H	5	0,44	9,00	40	17,60	395

Ductile Reliefs

Kendo is the collection inspired by the Jura stone that now presents two reliefs in ductile. Both with striated reliefs in parallel lines, each with a different intensity. List refers to the finer line relief, which overall has a softened tactile effect. The more intense relief is called Loop and maintains a visual balance thanks to the uniformity of the volumes.

Kendo es la colección inspirada en la piedra Jura que presenta ahora dos relieves en Ductile. Ambos con relieves acanalados en líneas paralelas, cada uno a una intensidad. List corresponde al relieve de líneas más finas, que en conjunto tiene un efecto táctil suavizado. El relieve más intenso recibe el nombre de Loop y mantiene un visual equilibrado gracias a la uniformidad de los volúmenes.



Kendo Ice
 List Relief
 Graphic Scale 1/3

3D-Fit®
 Technology

Rectified / Destonified V.3 / Rectificado / Destonificado V.3
 N° Designs By Format / N° De Diseños Por Formato : D-60x120: 14-24

Kendo Ice
 Loop Relief
 Graphic Scale 1/3

Available Colours:

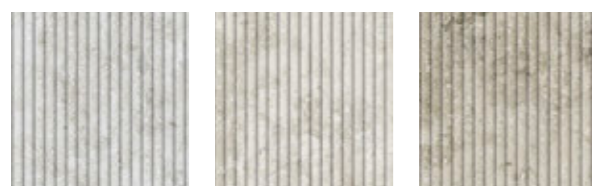

Kendo Ice

Kendo Light

Kendo Classic

Ductile Reliefs

Ductile Wall Tiles · Revestimientos Ductile

Available Sizes / Formatos Disponibles

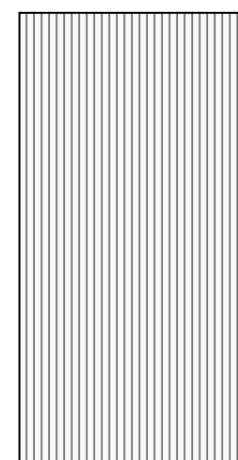

LIST
 Ductile
 60x120x0,9 cm.
 24"x48"

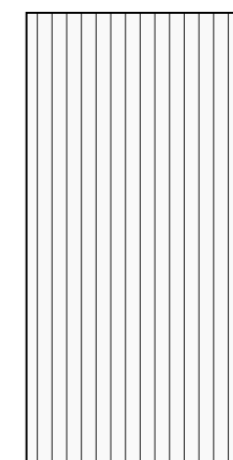

LOOP
 Ductile
 60x120x0,9 cm.
 24"x48"

Wall Tiles Available Sizes & Finishes / Formatos y Acabados Disponibles en Revestimientos Cerámicos

Nominal Size Formato Nominal	Real Size Formato Real	List	Loop	Price Code	Pz/Box	M2/Box	Kg/Box	Box/Pa	M2/Pa	Kg/Pa
Ductile Relief 60x120 cm. 24"x48"	59,8x119,8x0,9 cm.	●	●	620	2	1,43	22,00	24	34,32	558



Soft Textured Finish Anti-slip Finish

Color Body Porcelain & Ductile / Porcelánico Masa Coloreada y Ductile
Rectified / Destonified V.2 / Rectificado / Destonificado V.2
N° Designs By Format / N° De Diseños Por Formato
120x270: 7 / D-90x270: 7 / D-60x120: 14 / 120x120: 14 / 60x120: 14 / 90x90: 16 / 45x90: 32 / 60x60: 28 / 30x60: 56

3D·Fit
Technology

Kovo Dark Grey
Soft Textured Finish
Escala 1/4

Available Colours:



*Kovo Light *Kovo Silver

*20mm. Thickness Available Colour
*Color Disponible en 20mm.

Available Sizes / Formatos Disponibles

Step Tile & Countertops Available. Consult Special Pieces Section.
Peldaños y Encimeras disponibles. Consulte la Sección de Piezas Especiales.

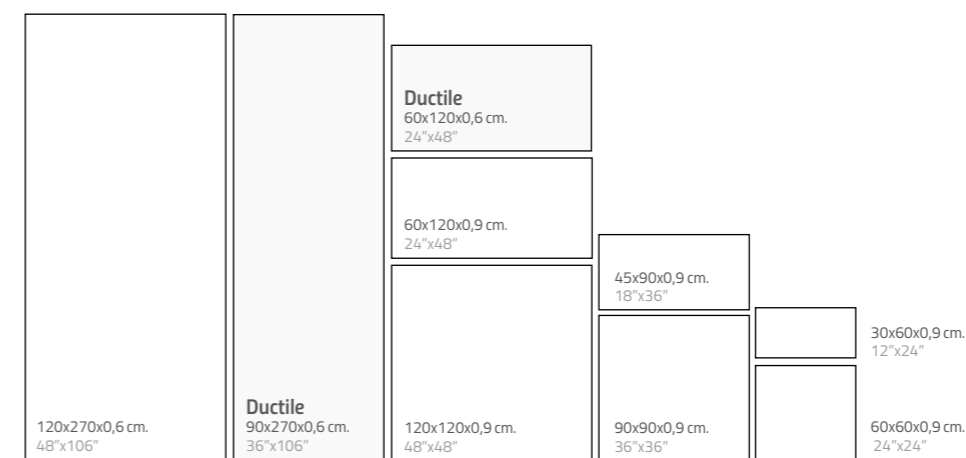

Complements / Complementos

- Mosaic 25
Net 12"x12"
Malla 30x30 cm.
Real 29,8x29,8 cm.
- Mosaic 55
Net 12"x12"
Malla 30x30 cm.
Real 29,8x29,8 cm.
- Moved Mosaic
Net 12"x12"
Malla 30x30 cm.
Real 29,8x29,8 cm.
- Mureto Mosaic
Net 12"x18"
Malla 30x45 cm.
Real 29,8x29,8 cm.

Ductile Wall Tiles Available Sizes & Finishes / Formatos y Acabados Disponibles en Revestimientos Ductile

Nominal Size Formato Nominal	Real Size Formato Real	Soft Textured	Price Code	Pz/Box	M2/Box	Kg/Box	Box/Pa	M2/Pa	Kg/Pa
Ductile 60x120 cm. 24"x48"	59,8x119,8x0,6 cm.	●	620	3	2,15	25,80	24	51,48	649
Ductile 90x270 cm. 36"x106"	89,8x269,8x0,6 cm.	●	970	1	2,42	29,04	24	58,08	801

Porcelain Tiles Available Sizes & Finishes / Formatos y Acabados Disponibles en Porcelánico

Nominal Size Formato Nominal	Real Size Formato Real	Soft Textured C1 · R9 · CA	Anti-Slip C3 · R11 · CC	Price Code	Pz/Box	M2/Box	Kg/Box	Box/Pa	M2/Pa	Kg/Pa
30x60 cm. 12"x24"	29,8x59,8x0,9 cm.	●	●	30	6	1,07	22,00	48	51,36	1094
60x60 cm. 24"x24"	59,8x59,8x0,9 cm.	●	●	60	3	1,07	23,22	40	42,91	962
45x90 cm. 18"x36"	44,8x89,8x0,9 cm.	●	●	45	3	1,21	25,50	32	38,62	849
90x90 cm. 36"x36"	89,8x89,8x0,9 cm.	●	●	90	2	1,61	34,00	24	38,71	846
*90x90x2 cm. 36"x36"	89,8x89,8x2 cm.	●	●	94	1	0,81	37,09	24	19,35	946
60x120 cm. 24"x48"	59,8x119,8x0,9 cm.	●	●	62	2	1,43	30,32	24	34,32	767
120x120 cm. 48"x48"	119,8x119,8x0,9 cm.	●	●	120	1	1,44	30,50	40	57,41	1265
*120x120x2 cm. 48"x48"	119,8x119,8x2 cm.	●	●	121	1	1,44	66,02	16	22,96	1140
120x270 cm. 48"x106"	119,8x269,8x0,6 cm.	●	●	276	1	3,23	45,50	24	77,52	1250
Mosaic 25	29,8x29,8x0,9 cm.	●	●	25	5	0,44	9,00	60	26,40	576
Mosaic 55	29,8x29,8x0,9 cm.	●	●	55	5	0,44	9,00	60	26,40	576
Moved Mosaic	29,8x29,8x0,9 cm.	●	●	302	5	0,44	9,00	60	26,40	576
Mureto Mosaic	29,8x29,8x0,9 cm.	●	●	300	5	0,44	9,00	40	17,60	395

Ductile Reliefs

Kovo is one of Livingceramics' core collections. Timeless and contemporary, it is now completed with two reliefs to increase its versatility. On the one hand, Veil is composed of small ultra-fine lines that result in a very subtle relief. On the other hand, Valle shows lines in a curved finish in different reliefs and at different distances from each other.

Kovo es una de las colecciones principales de Livingceramics. Atemporal y contemporánea, ahora se completa con dos relieves para aumentar su versatilidad. Por una parte, Veil se compone de pequeñas líneas ultra finas que dan como resultado un relieve muy sutil. Valle muestra líneas en acabado curvo a distintos relieves y con distancias dispares entre sí.



Kovo Silver
Veil Relief
Graphic Scale 1/3

3D-Fit®
Technology

Rectified / Destonified V.2 / Rectificado / Destonificado V.2
N° Designs By Format / N° De Diseños Por Formato : D-60x120: 14-24

Kovo Silver
Valle Relief
Graphic Scale 1/3

Ductile Reliefs

Ductile Wall Tiles · Revestimientos Ductile

Available Sizes / Formatos Disponibles

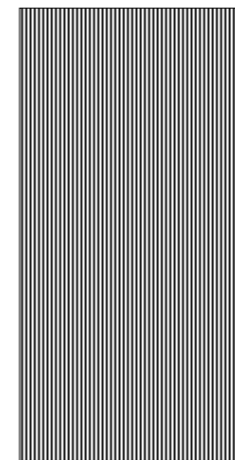

VEIL
Ductile
60x120x0,9 cm.
24"x48"

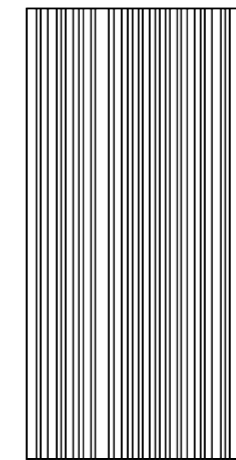

VALLE
Ductile
60x120x0,9 cm.
24"x48"

Available Colours:

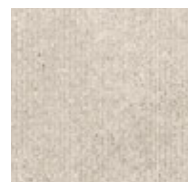

Kovo Light

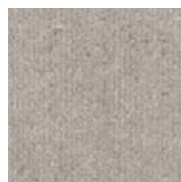

Kovo Silver

Wall Tiles Available Sizes & Finishes / Formatos y Acabados Disponibles en Revestimientos Cerámicos

Nominal Size Formato Nominal	Real Size Formato Real	Veil	Valle	Price Code	Pz/Box	M2/Box	Kg/Box	Box/Pa	M2/Pa	Kg/Pa
Ductile Relief 60x120 cm. 24"x48"	59,8x119,8x0,9 cm.	●	●	620	2	1,43	22,00	24	34,32	558



Soft Textured Finish Anti-slip Finish

Color Body Porcelain & Ductile / Porcelánico Masa Coloreada y Ductile
Rectified / Destonified V.2 / Rectificado / Destonificado V.2
N° Designs By Format / N° De Diseños Por Formato :
120x270: 7 / D-90x270: 7 / D-60x120: 14 / 120x120: 14 / 60x120: 14 / 90x90: 16 / 45x90: 32 / 60x60: 28 / 30x60: 56

3D-Fit®
Technology

Noon Grey
Soft Textured Finish
Escala 1/4

Available Sizes / Formatos Disponibles

Step Tile & Countertops Available. Consult Special Pieces Section.
Peldaños y Encimeras disponibles. Consulte la Sección de Piezas Especiales.

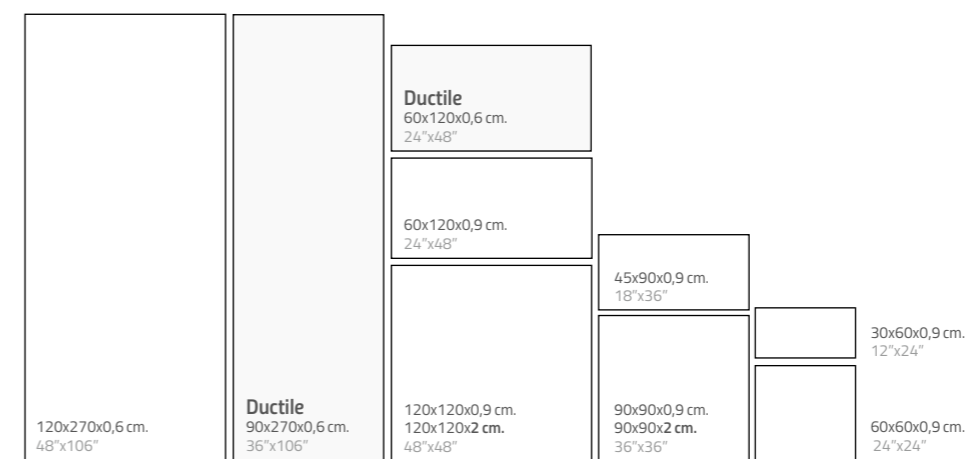

Complements / Complementos



Deco Mosaic
Net 24"x24"
Malla 60x60 cm.
Real 59,8x59,8 cm.



Mosaic 25
Net 12"x12"
Malla 30x30 cm.
Real 29,8x29,8 cm.

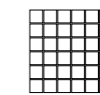

Mosaic 55
Net 12"x12"
Malla 30x30 cm.
Real 29,8x29,8 cm.

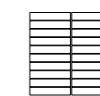

Mosaic 315
Net 12"x12"
Malla 30x30 cm.
Real 29,8x29,8 cm.

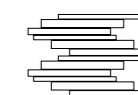

Mureto Mosaic
Net 12"x18"
Malla 30x45 cm.
Real 29,8x29,8 cm.

Ductile Wall Tiles Available Sizes & Finishes / Formatos y Acabados Disponibles en Revestimientos Ductile

Nominal Size Formato Nominal	Real Size Formato Real	Soft Textured	Price Code	Pz/Box	M2/Box	Kg/Box	Box/Pa	M2/Pa	Kg/Pa
Ductile 60x120 cm. 24"x48"	59,8x119,8x0,6 cm.	●	620	3	2,15	25,80	24	51,48	649
Ductile 90x270 cm. 36"x106"	89,8x269,8x0,6 cm.	●	970	1	2,42	29,04	24	58,08	801

Porcelain Tiles Available Sizes & Finishes / Formatos y Acabados Disponibles en Porcelánico

Nominal Size Formato Nominal	Real Size Formato Real	Soft Textured C1 · R9 · CA	Anti-Slip C3 · R11 · CC	Price Code	Pz/Box	M2/Box	Kg/Box	Box/Pa	M2/Pa	Kg/Pa
30x60 cm. 12"x24"	29,8x59,8x0,9 cm.	●	●	30	6	1,07	22,00	48	51,36	1094
60x60 cm. 24"x24"	59,8x59,8x0,9 cm.	●	●	60	3	1,07	23,22	40	42,91	962
45x90 cm. 18"x36"	44,8x89,8x0,9 cm.	●	●	45	3	1,21	25,50	32	38,62	849
90x90 cm. 36"x36"	89,8x89,8x0,9 cm.	●	●	90	2	1,61	34,00	24	38,71	846
*90x90x2 cm. 36"x36"	89,8x89,8x2 cm.	●	●	94	1	0,81	37,09	24	19,35	946
60x120 cm. 24"x48"	59,8x119,8x0,9 cm.	●	●	62	2	1,43	30,32	24	34,32	767
120x120 cm. 48"x48"	119,8x119,8x0,9 cm.	●	●	120	1	1,44	30,50	40	57,41	1265
*120x120x2 cm. 48"x48"	119,8x119,8x2 cm.	●	●	121	1	1,44	66,02	16	22,96	1140
120x270 cm. 48"x106"	119,8x269,8x0,6 cm.	●	●	276	1	3,23	45,50	24	77,52	1250
Mosaic 25	29,8x29,8x0,9 cm.	●	●	25	5	0,44	9,00	60	26,40	576
Mosaic 55	29,8x29,8x0,9 cm.	●	●	55	5	0,44	9,00	60	26,40	576
Mosaic 315	29,8x29,8x0,9 cm.	●	●	315	5	0,44	9,00	60	26,40	576
Mureto Mosaic	29,8x29,8x0,9 cm.	●	●	300	5	0,44	9,00	40	17,60	395
Deco Mosaic	59,8x59,8x0,9 cm.	●	●	560	4	0,92	20,00	24	22,10	510

Available Colours:



*Noon Sand *Noon Grey Noon Anthracite

*20mm. Thickness Available Colour
*Color Disponible en 20mm.



Ductile Reliefs

Already a Livingceramics classic, the Noon Series now has two wall reliefs for Ductile tiles. Both have edges at the top, arranged parallel and with a uniform distance from each other. These reliefs are available in two versions. Angle, with thin sides. And Arrow, with a larger relief.

Convertida ya en un clásico de Livingceramics, la Serie Noon cuenta ahora con dos relieves para revestimientos Ductile. Ambos presentan aristas en la parte superior, ordenadas en paralelo y con distancia uniforme las unas de las otras. Estos relieves están disponibles en dos versiones. Angle, con laterales finos. Y Arrow, con un relieve más amplio.

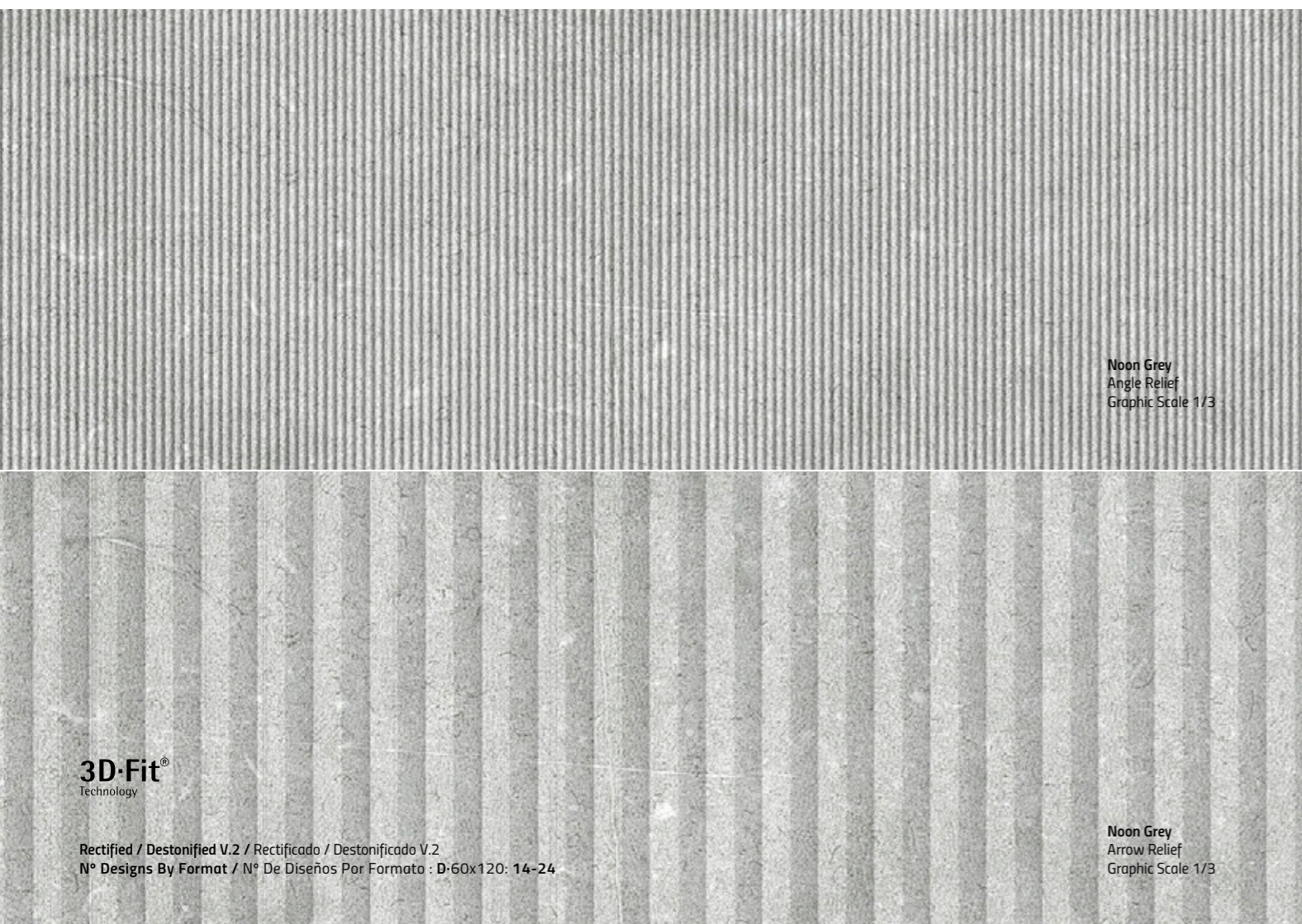

Ductile Reliefs

Ductile Wall Tiles · Revestimientos Ductile

Available Sizes / Formatos Disponibles

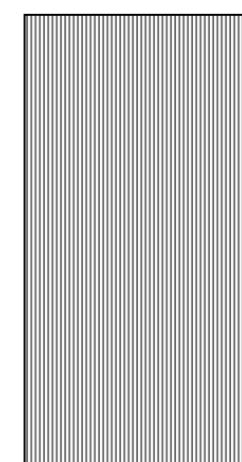

ANGLE
 Ductile
 60x120x0,9 cm.
 24"x48"

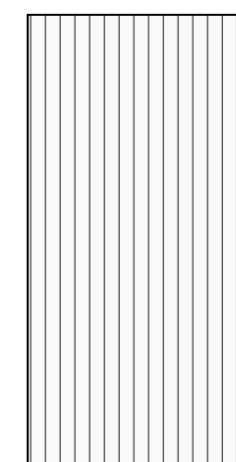

ARROW
 Ductile
 60x120x0,9 cm.
 24"x48"

Available Colours:

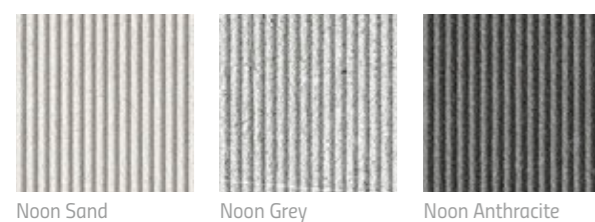

Wall Tiles Available Sizes & Finishes / Formatos y Acabados Disponibles en Revestimientos Cerámicos

Nominal Size Formato Nominal	Real Size Formato Real	Angle	Arrow	Price Code	Pz/Box	M2/Box	Kg/Box	Box/Pa	M2/Pa	Kg/Pa
Ductile Relief 60x120 cm. 24"x48"	59,8x119,8x0,9 cm.	●	●	620	2	1,43	22,00	24	34,32	558

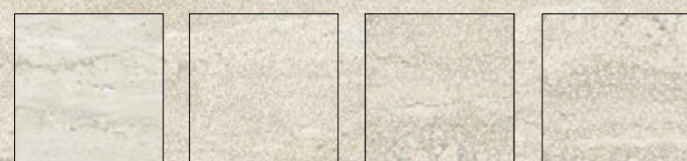

Honed Finish Soft Textured Finish B.H. Finish B.H. Anti-Slip Finish

Color Body Porcelain & Ductile / Porcelánico Masa Coloreada y Ductile
Rectified / Destonified V.2 / Rectificado / Destonificado V.2
N° Designs By Format / N° De Diseños Por Formato :
120x270: **7** / D-90x270: **7** / D-60x120: **24** / 120x120: **14** / 60x120: **24** / 90x90: **16** / 45x90: **32** / 60x60: **48** / 30x60: **96**

3D-Fit®
Technology

Verso Vein Cut Classic
Soft Textured Finish
Escala 1/4

Available Colours / Colores Disponibles

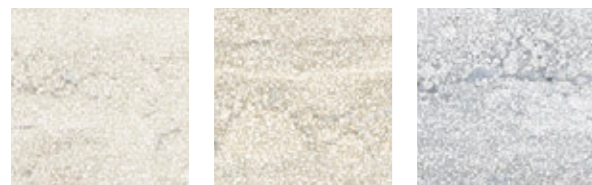

*Verso Vein Cut Light *Verso Vein Cut Classic Verso Vein Cut Grey

*20mm. Thickness Available Colour
*Color Disponible en 20mm.

Available Sizes / Formatos Disponibles

Step Tile & Countertops Available. Consult Special Pieces Section.
Peldaños y Encimeras disponibles. Consulte la Sección de Piezas Especiales.

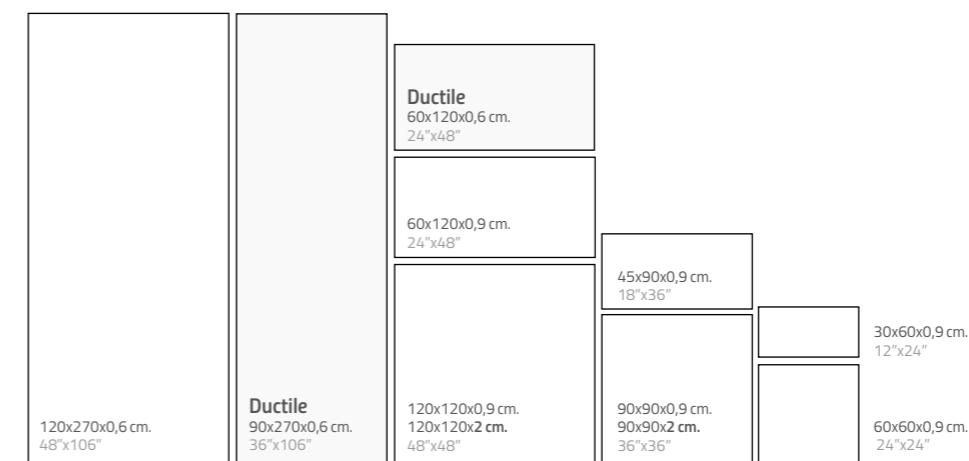

Complements / Complementos



Ductile Wall Tiles Available Sizes & Finishes / Formatos y Acabados Disponibles en Revestimientos Ductile

Nominal Size Formato Nominal	Real Size Formato Real	Soft Textured	Price Code	Pz/Box	M2/Box	Kg/Box	Box/Pa	M2/Pa	Kg/Pa
Ductile 60x120 cm. 24"x48"	59,8x119,8x0,6 cm.	●	620	3	2,15	25,80	24	51,48	649
Ductile 90x270 cm. 36"x106"	89,8x269,8x0,6 cm.	●	970	1	2,42	29,04	24	58,08	801

Porcelain Tiles Available Sizes & Finishes / Formatos y Acabados Disponibles en Porcelánico

Nominal Size Formato Nominal	Real Size Formato Real	Honed	Soft Textured C2-R10-CB	B.Hammered C2-R10-CB	B. H. Anti-Slip C3-R11-CC	Price Code	Pz/Box	M2/Box	Kg/Box	Box/Pa	M2/Pa	Kg/Pa
30x60 cm. 12"x24"	29,8x59,8x0,9 cm.	●	●		●	30 / 30H	6	1,07	22,00	48	51,36	1094
60x60 cm. 24"x24"	59,8x59,8x0,9 cm.	●	●		●	60 / 60H	3	1,07	23,22	40	42,91	962
45x90 cm. 18"x36"	44,8x89,8x0,9 cm.	●	●		●	45 / 45H	3	1,21	25,50	32	38,62	849
90x90 cm. 36"x36"	89,8x89,8x0,9 cm.	●	●		●	90 / 90H	2	1,61	34,00	24	38,71	846
*90x90x2 cm. 36"x36"	89,8x89,8x2 cm.				●	94	1	0,81	37,09	24	19,35	946
60x120 cm. 24"x48"	59,8x119,8x0,9 cm.	●	●		●	62 / 62H	2	1,43	30,32	24	34,32	767
120x120 cm. 48"x48"	119,8x119,8x0,9 cm.	●	●		●	120 / 120H	1	1,44	30,50	40	57,41	1265
*120x120x2 cm. 48"x48"	119,8x119,8x2 cm.				●	121	1	1,44	66,02	16	22,96	1140
120x270 cm. 48"x106"	119,8x269,8x0,6 cm.	●	●	●		276 / 276H	1	3,23	45,50	24	77,52	1250
Mosaic 25	29,8x29,8x0,9 cm.	●	●		●	25 / 25H	5	0,44	9,00	60	26,40	576
Mosaic 55	29,8x29,8x0,9 cm.	●	●		●	55 / 55H	5	0,44	9,00	60	26,40	576
Mureto Mosaic	29,8x29,8x0,9 cm.	●	●		●	300 / 300H	5	0,44	9,00	40	17,60	395

Ductile Reliefs

The richness of the Verso surface is reinforced by the two new wall tiles with relief. Arpa and Arco are reliefs created from parallel and symmetrical lines. The surface is flat and the grooves are in the shape of a semicircle. Both are available in two graphics. Vein Cut, the graphics in favor of the vein that reveals the travertine strata. And Cross Cut, the graphic against the vein.

La riqueza en la superficie de Verso se refuerza con los dos nuevos revestimientos en relieve. Arpa y Arco son relieves creados a partir de líneas paralelas y simétricas. La superficie es plana y las ranuras tienen forma de semicírculo. Ambas están disponibles en dos gráficas. Vein Cut, la gráfica a favor de la veta que revela los estratos del travertino. Y Cross Cut, la gráfica a contraveta.



Ductile Reliefs

Ductile Wall Tiles · Revestimientos Ductile

Available Sizes / Formatos Disponibles

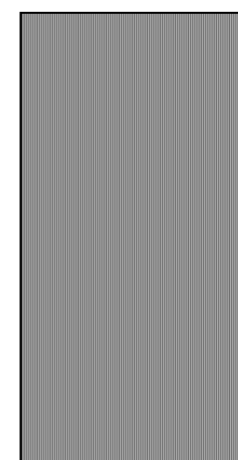

ARPA
Ductile
60x120x0,9 cm.
24"x48"

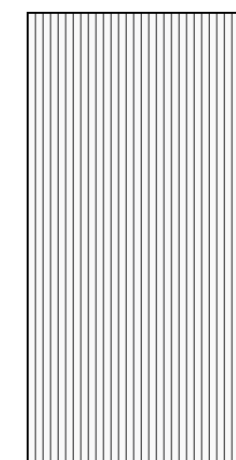

ARCO
Ductile
60x120x0,9 cm.
24"x48"

Available Colours / Colores Disponibles



Verso Vein Cut Light Verso Vein Cut Classic Verso Vein Cut Grey

Wall Tiles Available Sizes & Finishes / Formatos y Acabados Disponibles en Revestimientos Cerámicos

Nominal Size Formato Nominal	Real Size Formato Real	Arpa	Arco	Price Code	Pz/Box	M2/Box	Kg/Box	Box/Pa	M2/Pa	Kg/Pa
Ductile Relief 60x120 cm. 24"x48"	59,8x119,8x0,9 cm.	●	●	620	2	1,43	22,00	24	34,32	558



Honed Finish Soft Textured Finish B.H. Finish B.H. Anti-Slip Finish

3D-Fit
Technology

Color Body Porcelain & Ductile / Porcelánico Masa Coloreada y Ductile
Rectified / Destonified V.2 / Rectificado / Destonificado V.2
N° Designs By Format / N° De Diseños Por Formato :
120x270: **7** / D-90x270: **7** / D-60x120: **24** / 120x120: **14** / 60x120: **24** / 90x90: **16** / 45x90: **32** / 60x60: **48** / 30x60: **96**

Verso Cross Cut Classic
Soft Textured Finish
Escala 1/4

Available Colours / Colores Disponibles

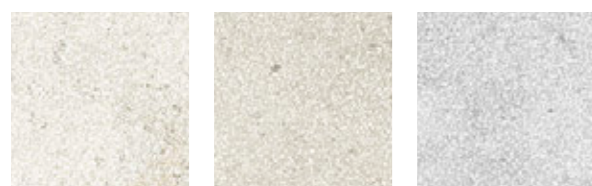

*Verso Cross Cut Light *Verso Cross Cut Classic Verso Cross Cut Grey

*20mm. Thickness Available Colour
*Color Disponible en 20mm.

Available Sizes / Formatos Disponibles

Step Tile & Countertops Available. Consult Special Pieces Section.
Peldaños y Encimeras disponibles. Consulte la Sección de Piezas Especiales.

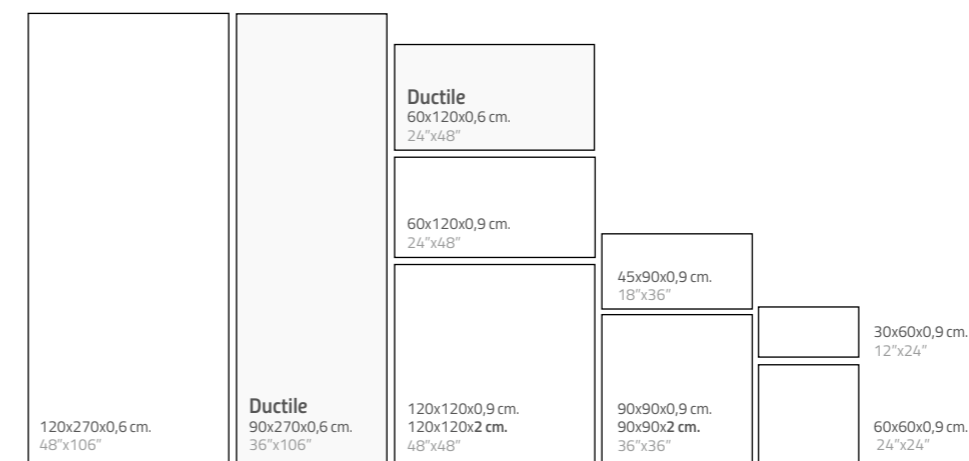

Complements / Complementos



Ductile Wall Tiles Available Sizes & Finishes / Formatos y Acabados Disponibles en Revestimientos Ductile

Nominal Size Formato Nominal	Real Size Formato Real	Soft Textured	Price Code	Pz/Box	M2/Box	Kg/Box	Box/Pa	M2/Pa	Kg/Pa
Ductile 60x120 cm. 24"x48"	59,8x119,8x0,6 cm.	●	620	3	2,15	25,80	24	51,48	649
Ductile 90x270 cm. 36"x106"	89,8x269,8x0,6 cm.	●	970	1	2,42	29,04	24	58,08	801

Porcelain Tiles Available Sizes & Finishes / Formatos y Acabados Disponibles en Porcelánico

Nominal Size Formato Nominal	Real Size Formato Real	Honed	Soft Textured C2-R10-CB	B.Hammered C2-R10-CB	B. H. Anti-Slip C3-R11-CC	Price Code	Pz/Box	M2/Box	Kg/Box	Box/Pa	M2/Pa	Kg/Pa
30x60 cm. 12"x24"	29,8x59,8x0,9 cm.	●	●		●	30 / 30H	6	1,07	22,00	48	51,36	1094
60x60 cm. 24"x24"	59,8x59,8x0,9 cm.	●	●		●	60 / 60H	3	1,07	23,22	40	42,91	962
45x90 cm. 18"x36"	44,8x89,8x0,9 cm.	●	●		●	45 / 45H	3	1,21	25,50	32	38,62	849
90x90 cm. 36"x36"	89,8x89,8x0,9 cm.	●	●		●	90 / 90H	2	1,61	34,00	24	38,71	846
*90x90x2 cm. 36"x36"	89,8x89,8x2 cm.				●	94	1	0,81	37,09	24	19,35	946
60x120 cm. 24"x48"	59,8x119,8x0,9 cm.	●	●		●	62 / 62H	2	1,43	30,32	24	34,32	767
120x120 cm. 48"x48"	119,8x119,8x0,9 cm.	●	●		●	120 / 120H	1	1,44	30,50	40	57,41	1265
*120x120x2 cm. 48"x48"	119,8x119,8x2 cm.				●	121	1	1,44	66,02	16	22,96	1140
120x270 cm. 48"x106"	119,8x269,8x0,6 cm.	●	●	●		276 / 276H	1	3,23	45,50	24	77,52	1250
Mosaic 25	29,8x29,8x0,9 cm.	●	●		●	25 / 25H	5	0,44	9,00	60	26,40	576
Mosaic 55	29,8x29,8x0,9 cm.	●	●		●	55 / 55H	5	0,44	9,00	60	26,40	576
Mureto Mosaic	29,8x29,8x0,9 cm.	●	●		●	300 / 300H	5	0,44	9,00	40	17,60	395

Ductile Reliefs

The richness of the Verso surface is reinforced by the two new wall tiles with relief. Arpa and Arco are reliefs created from parallel and symmetrical lines. The surface is flat and the grooves are in the shape of a semicircle. Both are available in two graphics. Vein Cut, the graphics in favor of the vein that reveals the travertine strata. And Cross Cut, the graphic against the vein.

La riqueza en la superficie de Verso se refuerza con los dos nuevos revestimientos en relieve. Arpa y Arco son relieves creados a partir de líneas paralelas y simétricas. La superficie es plana y las ranuras tienen forma de semicírculo. Ambas están disponibles en dos gráficas. Vein Cut, la gráfica a favor de la veta que releva los estratos del travertino. Y Cross Cut, la gráfica a contraveta.



Ductile Reliefs

Ductile Wall Tiles · Revestimientos Ductile

Available Sizes / Formatos Disponibles

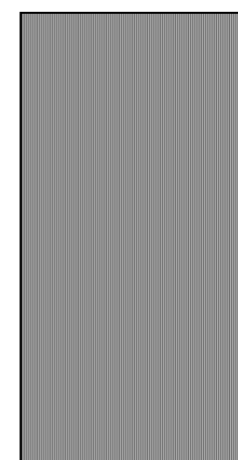

ARPA
Ductile
60x120x0,9 cm.
24"x48"

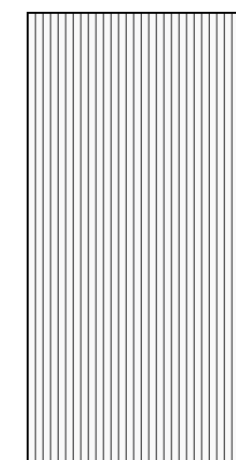

ARCO
Ductile
60x120x0,9 cm.
24"x48"

Available Colours / Colores Disponibles



Verso Cross Cut Light Verso Cross Cut Classic Verso Cross Cut Grey

Wall Tiles Available Sizes & Finishes / Formatos y Acabados Disponibles en Revestimientos Cerámicos

Nominal Size Formato Nominal	Real Size Formato Real	Arpa	Arco	Price Code	Pz/Box	M2/Box	Kg/Box	Box/Pa	M2/Pa	Kg/Pa
Ductile Relief 60x120 cm. 24"x48"	59,8x119,8x0,9 cm.	●	●	620	2	1,43	22,00	24	34,32	558



Honed Finish Soft Textured Finish B.H. Finish B.H. Anti-Slip Finish

Color Body Porcelain & Ductile / Porcelánico Masa Coloreada y Ductile
Rectified / Destonified V.3 / Rectificado / Destonificado V.3
N° Designs By Format / N° De Diseños Por Formato :
120x270: 7 / D-90x270: 7 / D-60x120: 24 / 120x120: 14 / 60x120: 24 / 90x90: 16 / 45x90: 32 / 60x60: 48 / 30x60: 96

3D-Fit
Technology

Vonn Greige
Soft Textured Finish
Escala 1/4

Available Colours:

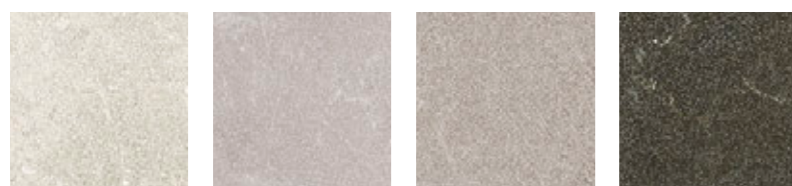

*Vonn Light *Vonn Grey Vonn Greige *Vonn Anthracite

*20mm. Thickness Available Colour
*Color Disponible en 20mm.

Available Sizes / Formatos Disponibles

Step Tile & Countertops Available. Consult Special Pieces Section.
Peldaños y Encimeras disponibles. Consulte la Sección de Piezas Especiales.

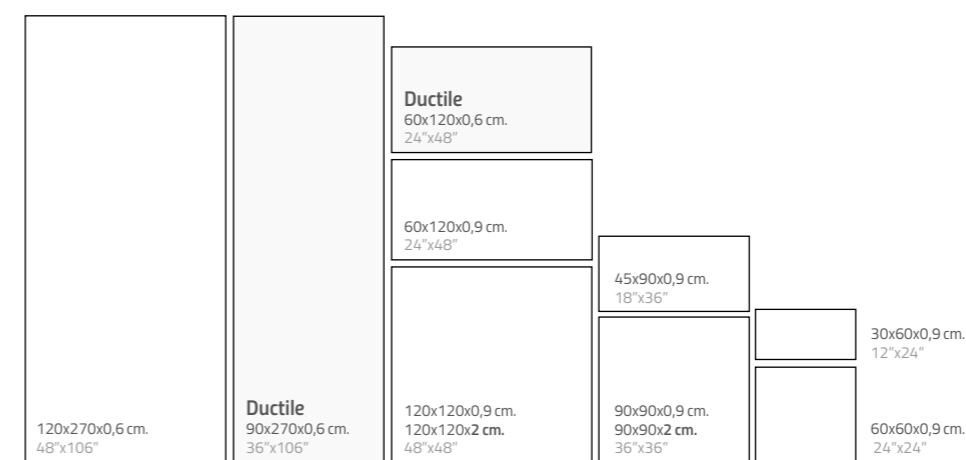

Complements / Complementos

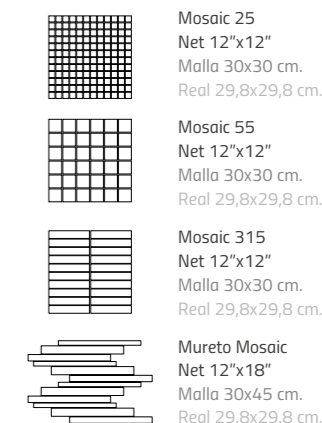

Ductile Wall Tiles Available Sizes & Finishes / Formatos y Acabados Disponibles en Revestimientos Ductile

Nominal Size Formato Nominal	Real Size Formato Real	Soft Textured	Price Code	Pz/Box	M2/ Box	Kg/Box	Box/Pa	M2/Pa	Kg/Pa
Ductile 60x120 cm. 24"x48"	59,8x119,8x0,6 cm.	●	620	3	2,15	25,80	24	51,48	649
Ductile 90x270 cm. 36"x106"	89,8x269,8x0,6 cm.	●	970	1	2,42	29,04	24	58,08	801

Porcelain Tiles Available Sizes & Finishes / Formatos y Acabados Disponibles en Porcelánico

Nominal Size Formato Nominal	Real Size Formato Real	Honed	Soft Textured C2-R10-CB	B.Hammered C2-R10-CB	B. H. Anti-Slip C3-R11-CC	Price Code	Pz/Box	M2/ Box	Kg/Box	Box/Pa	M2/Pa	Kg/Pa
30x60 cm. 12"x24"	29,8x59,8x0,9 cm.	●	●		●	30 / 30H	6	1,07	22,00	48	51,36	1094
60x60 cm. 24"x24"	59,8x59,8x0,9 cm.	●	●		●	60 / 60H	3	1,07	23,22	40	42,91	962
45x90 cm. 18"x36"	44,8x89,8x0,9 cm.	●	●		●	45 / 45H	3	1,21	25,50	32	38,62	849
90x90 cm. 36"x36"	89,8x89,8x0,9 cm.	●	●		●	90 / 90H	2	1,61	34,00	24	38,71	846
*90x90x2 cm. 36"x36"	89,8x89,8x2 cm.				●	94	1	0,81	37,09	24	19,35	946
60x120 cm. 24"x48"	59,8x119,8x0,9 cm.	●	●		●	62 / 62H	2	1,43	30,32	24	34,32	767
120x120 cm. 48"x48"	119,8x119,8x0,9 cm.	●	●		●	120 / 120H	1	1,44	30,50	40	57,41	1265
*120x120x2 cm. 48"x48"	119,8x119,8x2 cm.				●	121	1	1,44	66,02	16	22,96	1140
120x270 cm. 48"x106"	119,8x269,8x0,6 cm.	●	●	●		276 / 276H	1	3,23	45,50	24	77,52	1250
Mosaic 25	29,8x29,8x0,9 cm.	●	●		●	25 / 25H	5	0,44	9,00	60	26,40	576
Mosaic 55	29,8x29,8x0,9 cm.	●	●		●	55 / 55H	5	0,44	9,00	60	26,40	576
Mosaic 315	29,8x29,8x0,9 cm.	●	●		●	315	5	0,44	9,00	60	26,40	576
Mureto Mosaic	29,8x29,8x0,9 cm.	●	●		●	300 / 300H	5	0,44	9,00	40	17,60	395

Ductile Reliefs

Livingceramics' soft marbling series launches two raised tiles with Ductile. Leaf, a herringbone-shaped relief in two directions and soft edges. And Loom, a parallel relief with also rounded edges but at different distances from each other. Two very different options capable of adapting to any decorative style.

La serie de marmoleado suave de Livingceramics lanza dos revestimientos en relieve con Ductile. Leaf, un relieve en forma de espiga con cantos suaves. Y Loom, un relieve paralelo de bordes también redondeados pero a diferentes distancias unas de las otras. Dos opciones muy diferentes entre sí capaces de adaptarse a cualquier estilo decorativo.



Ductile Reliefs

Ductile Wall Tiles · Revestimientos Ductile

Available Sizes / Formatos Disponibles

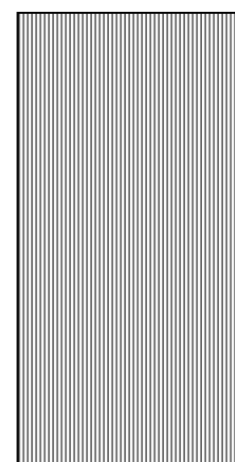

LOOM
Ductile
60x120x0,9 cm.
24"x48"

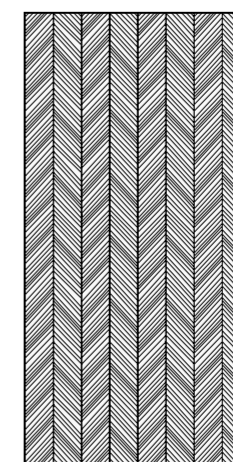

LEAF
Ductile
60x120x0,9 cm.
24"x48"

Available Colours:



Vonn Light

Vonn Grey

Vonn Greige

Wall Tiles Available Sizes & Finishes / Formatos y Acabados Disponibles en Revestimientos Cerámicos

Nominal Size Formato Nominal	Real Size Formato Real	Loom	Leaf	Price Code	Pz/Box	M2/Box	Kg/Box	Box/Pa	M2/Pa	Kg/Pa
Ductile Relief 60x120 cm. 24"x48"	59,8x119,8x0,9 cm.	●	●	620	2	1,43	22,00	24	34,32	558



Soft Textured Finish

Through-Body Porcelain / Porcelánico Técnico Todo Masa
Rectified / Destonified V.2 / Rectificado / Destonificado V.2
N° Designs By Format / N° De Diseños Por Formato :
Unlimited designs by Format.

3D-Fit[®]
Technology

Corelith[®]
Technology

Kron Grey
Soft Textured Finish
Escala 1/3

Available Colours:



Kron Grey

Through-Body Porcelain / Porcelánico Todo Masa

The full body porcelain tile delivers certain advantages vs other collections, without losing all benefits the glaze porcelain offers, its main feature resides in its inside. The raw material that shapes the tile become uniform without any superficial decoration that delivers the same aesthetic throughout the tile, this particularity make it the best fit for all those spaces that demand the most hard wearing materials.

La cerámica técnica de alto rendimiento confiere ciertas ventajas con respecto a otras colecciones. Sin dejar de ofrecer todos los beneficios de un Gres Porcelánico, su característica más evidente se encuentra en su interior. La masa cerámica que conforma la pieza pasa a ser uniforme y deja de utilizarse una decoración superficial, para conferir a toda la pieza el mismo aspecto, incluyendo laterales e interior. Esta particularidad lo hace idóneo para revestir espacios con alto tráfico peatonal sometidos a un gran desgaste y que necesiten de un pavimento que ofrezca las más altas garantías superficiales.

Available Sizes / Formatos Disponibles

Step Tile & Countertops Availables. Consult Special Pieces Section.
Peldaños y Encimeras disponibles. Consulte la Sección de Piezas Especiales.

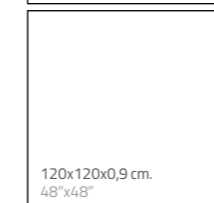

Tech. Porcelain Tiles Available Sizes & Finishes / Formatos y Acabados Disponibles en Porcelánico Tec.

Nominal Size Formato Nominal	Real Size Formato Real	Soft Textured R10 · CB	Price Code	Pz/Box	M2/Box	Kg/Box	Box/Pa	M2/Pa	Kg/Pa
60x120 cm. 24"x48"	59,8x119,8x0,9 cm.	●	62T	2	1,43	30,32	24	34,32	728
120x120 cm. 48"x48"	119,8x119,8x0,9 cm.	●	120T	1	1,44	30,50	40	57,41	1265

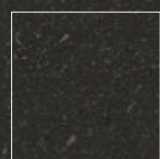

Soft Textured Finish

Through-Body Porcelain / Porcelánico Técnico Todo Masa
 Rectified / Destonified V.2 / Rectificado / Destonificado V.2
 N° Designs By Format / N° De Diseños Por Formato :
 Unlimited designs by Format.

3D-Fit®
 Technology

Corelith®
 Technology

Wega Black
 Soft Textured Finish
 Escala 1/3

Available Colours:

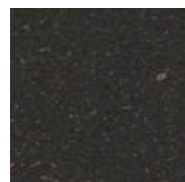

Wega Black

Through-Body Porcelain / Porcelánico Todo Masa

The full body porcelain tile delivers certain advantages vs other collections, without losing all benefits the glaze porcelain offers, its main feature resides in its inside. The raw material that shapes the tile become uniform without any superficial decoration that delivers the same aesthetic throughout the tile, this particularity make it the best fit for all those spaces that demand the most hard wearing materials.

La cerámica técnica de alto rendimiento confiere ciertas ventajas con respecto a otras colecciones. Sin dejar de ofrecer todos los beneficios de un Gres Porcelánico, su característica más evidente se encuentra en su interior. La masa cerámica que conforma la pieza pasa a ser uniforme y deja de utilizarse una decoración superficial, para conferir a toda la pieza el mismo aspecto, incluyendo laterales e interior. Esta particularidad lo hace idóneo para revestir espacios con alto tráfico peatonal sometidos a un gran desgaste y que necesiten de un pavimento que ofrezca las más altas garantías superficiales.

Available Sizes / Formatos Disponibles

Step Tile & Countertops Availables. Consult Special Pieces Section.
 Peldaños y Encimeras disponibles. Consulte la Sección de Piezas Especiales.

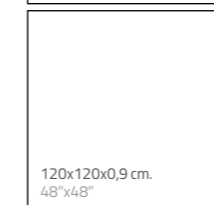
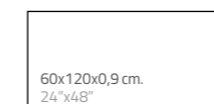

Tech. Porcelain Tiles Available Sizes & Finishes / Formatos y Acabados Disponibles en Porcelánico Tec.

Nominal Size Formato Nominal	Real Size Formato Real	Soft Textured R10 - CB	Price Code	Pz/Box	M2/Box	Kg/Box	Box/Pa	M2/Pa	Kg/Pa
60x120 cm. 24"x48"	59,8x119,8x0,9 cm.	●	62T	2	1,43	30,32	24	34,32	728
120x120 cm. 48"x48"	119,8x119,8x0,9 cm.	●	120T	1	1,44	30,50	40	57,41	1265

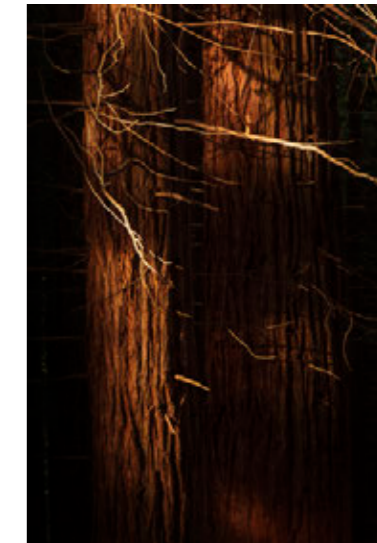

WOOD TRIBUTE COLLECTION

Tribute is a project in praise of nature. Going deeper into a material as incredible as wood and designing based on its aesthetics has allowed us to obtain a collection of series understood from a contemporary perspective.

Tribute es un proyecto de elogio a la naturaleza. Profundizar en un material tan increíble como la madera y diseñar partiendo de su estética nos ha permitido obtener una colección de series entendidas desde una perspectiva contemporánea.

Livingceramics

WOOD TRIBUTE COLLECTION

Due

Natural Brushed Oak in Ceramics
Roble Natural Cepillado en Cerámica



Soft Textured Finish Anti-slip Finish

Color Body Porcelain / Porcelánico Masa Coloreada
Rectified / Destonified V.3 / Rectificado / Destonificado V.3
N° Designs By Format / N° De Diseños Por Formato :
22,5x200: 32 / 22,5x160: 32 / 20x120: 33

3D-Fit®
Technology

Due Cognac
Soft Textured Finish
Escala 1/4

Available Sizes / Formatos Disponibles

Step Tile & Countertops Availables. Consult Special Pieces Section.
Peldaños y Encimeras disponibles. Consulte la Sección de Piezas Especiales.



20x120x0,9 cm.
8"x48"



22,5x160x0,9 cm.
9"x63"



22,5x200x0,9 cm.
9"x79"

Complements / Complementos



Mosaic 330
Net 12"x12"
Malla 30x30 cm.
Real 29,8x29,8 cm.

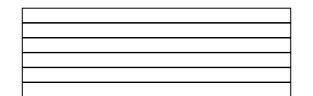

Mosaic 590
Net 12"x36"
Malla 30x90 cm.
Real 29,8x89,8 cm.

Available Colours / Colores Disponibles



Due Light

Due Sand

Due Canella

Due Cognac

Due Walnut

Porcelain Tiles Available Sizes & Finishes / Formatos y Acabados Disponibles en Porcelánico

Nominal Size Formato Nominal	Real Size Formato Real	Soft Textured C2 · R10 · CB	Anti-Slip C3 · R11	Price Code	Pz/Box	M2/Box	Kg/Box	Box/Pa	M2/Pa	Kg/Pa
20x120 cm. 8"x48"	19,8x119,8x0,9 cm.	●	●	20	5	1,19	25,15	45	53,55	1165
22,5x160 cm. 9"x63"	22,3x159,8x0,9 cm.	●		23	3	1,06	22,13	54	57,72	1230
22,5x200 cm. 9"x79"	22,3x199,8x0,9 cm.	●		22	3	1,33	27,69	42	56,14	1163
Mosaic 330	29,8x29,8x0,9 cm.	●		330	5	0,44	10,50	60	26,40	666
Mosaic 590	29,8x89,8x0,9 cm.	●		590	3	0,81	18,30	20	16,20	398

**WOOD
TRIBUTE
COLLECTION**

Giro
Natural Pine in Ceramics
Pino Natural en Cerámica



Soft Textured Finish Anti-slip Finish

Color Body Porcelain / Porcelánico Masa Coloreada
Rectified / Destonified V.2 / Rectificado / Destonificado V.2
N° Designs By Format / N° De Diseños Por Formato :
22,5x200: 24 / 22,5x160: 24 / 20x120: 33

3D-Fit®
Technology

Giro Light
Soft Textured Finish
Escala 1/4

Available Sizes / Formatos Disponibles

Step Tile & Countertops Availables. Consult Special Pieces Section.
Peldaños y Encimeras disponibles. Consulte la Sección de Piezas Especiales.



20x120x0,9 cm.
8"x48"



22,5x160x0,9 cm.
9"x63"



22,5x200x0,9 cm.
9"x79"

Complements / Complementos

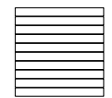

Mosaic 330
Net 12"x12"
Malla 30x30 cm.
Real 29,8x29,8 cm.

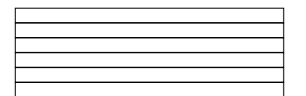

Mosaic 590
Net 12"x36"
Malla 30x90 cm.
Real 29,8x89,8 cm.

Available Colours / Colores Disponibles



Giro Light Giro Sand Giro Cream

Porcelain Tiles Available Sizes & Finishes / Formatos y Acabados Disponibles en Porcelánico

Nominal Size Formato Nominal	Real Size Formato Real	Soft Textured C2 · R10 · CB	Anti-Slip C3 · R11	Price Code	Pz/Box	M2/Box	Kg/Box	Box/Pa	M2/Pa	Kg/Pa
20x120 cm. 8"x48"	19,8x119,8x0,9 cm.	●	●	20	5	1,19	25,15	45	53,55	1165
22,5x160 cm. 9"x63"	22,3x159,8x0,9 cm.	●		23	3	1,06	22,13	54	57,72	1230
22,5x200 cm. 9"x79"	22,3x199,8x0,9 cm.	●		22	3	1,33	27,69	42	56,14	1163
Mosaic 330	29,8x29,8x0,9 cm.	●		330	5	0,44	10,50	60	26,40	666
Mosaic 590	29,8x89,8x0,9 cm.	●		590	3	0,81	18,30	20	16,20	398

**WOOD
TRIBUTE
COLLECTION**

Kora
Wildwood in Ceramics
Madera Salvaje en Cerámica



Soft Textured Finish Anti-slip Finish

Color Body Porcelain / Porcelánico Masa Coloreada
Rectified / Destonified V.3 / Rectificado / Destonificado V.3
N° Designs By Format / N° De Diseños Por Formato :
22,5x200: 32 / 22,5x160: 32 / 20x120: 33

3D-Fit®
Technology

Kora Autumn
Soft Textured Finish
Escala 1/3

Available Sizes / Formatos Disponibles

Step Tile & Countertops Availables. Consult Special Pieces Section.
Peldaños y Encimeras disponibles. Consulte la Sección de Piezas Especiales.



20x120x0,9 cm.
8"x48"



22,5x160x0,9 cm.
9"x63"



22,5x200x0,9 cm.
9"x79"

Complements / Complementos



Mosaic 330
Net 12"x12"
Malla 30x30 cm.
Real 29,8x29,8 cm.

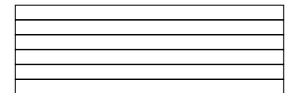

Mosaic 590
Net 12"x36"
Malla 30x90 cm.
Real 29,8x89,8 cm.

Available Colours / Colores Disponibles

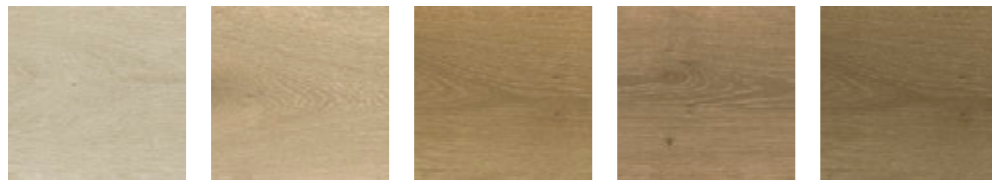

Kora Sand Kora Canela Kora Autumn Kora Cognac Kora Walnut

Porcelain Tiles Available Sizes & Finishes / Formatos y Acabados Disponibles en Porcelánico

Nominal Size Formato Nominal	Real Size Formato Real	Soft Textured C2 · R10 · CB	Anti-Slip C3 · R11	Price Code	Pz/Box	M2/Box	Kg/Box	Box/Pa	M2/Pa	Kg/Pa
20x120 cm. 8"x48"	19,8x119,8x0,9 cm.	●	●	20	5	1,19	25,15	45	53,55	1165
22,5x160 cm. 9"x63"	22,3x159,8x0,9 cm.	●		23	3	1,06	22,13	54	57,72	1230
22,5x200 cm. 9"x79"	22,3x199,8x0,9 cm.	●		22	3	1,33	27,69	42	56,14	1163
Mosaic 330	29,8x29,8x0,9 cm.	●		330	5	0,44	10,50	60	26,40	666
Mosaic 590	29,8x89,8x0,9 cm.	●		590	3	0,81	18,30	20	16,20	398

Ductile Reliefs

Kora is the new Livingceramics collection inspired by wood. This series presents a surface with a shade-matched marking which becomes more intense thanks to the digital printing of 3D-Fit. The wall reliefs for this collection are formed from ordered semicircles of two different sizes. Cozy, with soft parallel semicircular pieces that offer a smooth effect. And Cabana, with broader lines and deeper grooves that create the effect of perfectly aligned reeds.

Kora es la nueva colección de Livingceramics inspirada en la madera. Esta serie presenta una superficie con marcado destonificado que coge fuerza gracias a la impresión digital de 3D-Fit. Los revestimientos en relieve para esta colección se forman a partir de semicírculos ordenados de dos tamaños distintos. Cozy, de líneas finas y con suaves piezas semicirculares paralelas que ofrecen un efecto suave y ordenado. Y Cabana, de líneas más amplias, con surcos más profundos que crean el efecto de cañas perfectamente alineadas.

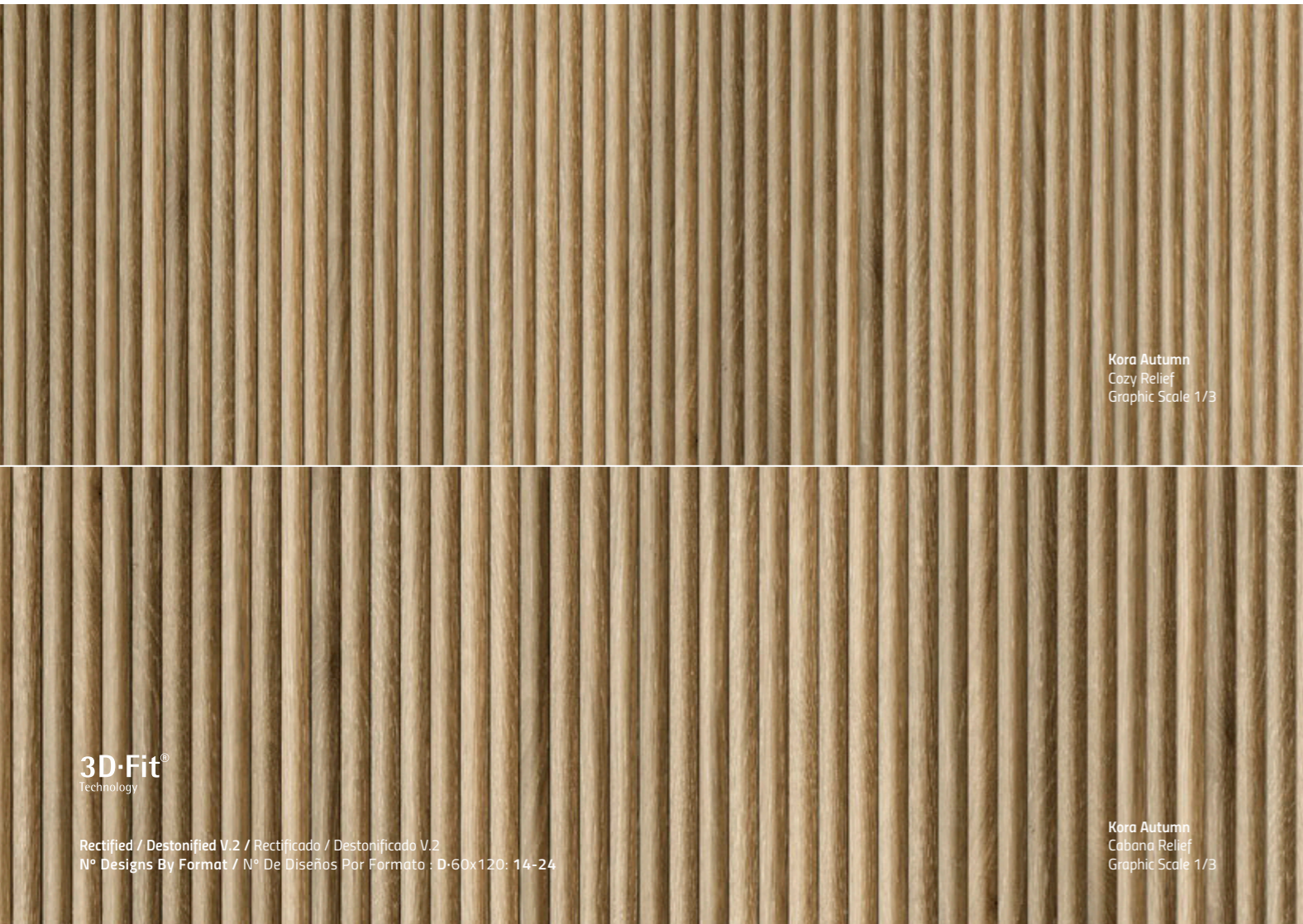

Kora Autumn
Cozy Relief
Graphic Scale 1/3

Kora Autumn
Cabana Relief
Graphic Scale 1/3

3D-Fit®
Technology

Rectified / Destonified V.2 / Rectificado / Destonificado V.2
Nº Designs By Format / Nº De Diseños Por Formato : D-60x120: 14-24

Available Colours / Colores Disponibles



Kora Sand

Kora Canella

Kora Autumn

Kora Cognac

Ductile Reliefs

Ductile Wall Tiles · Revestimientos Ductile

Available Sizes / Formatos Disponibles

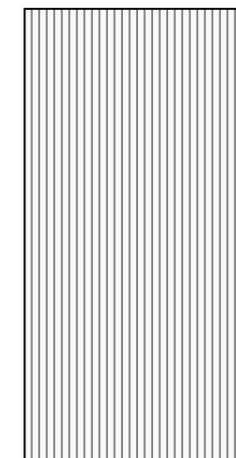

COZY
Ductile
60x120x0,9 cm.
24"x48"

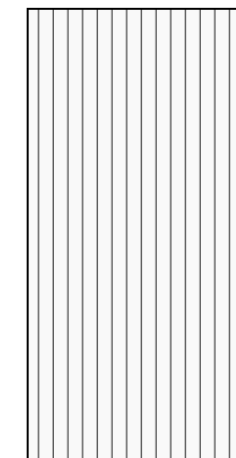

CABANA
Ductile
60x120x0,9 cm.
24"x48"

Wall Tiles Available Sizes & Finishes / Formatos y Acabados Disponibles en Revestimientos Cerámicos

Nominal Size Formato Nominal	Real Size Formato Real	Cozy	Cabana	Price Code	Pz/Box	M2/Box	Kg/Box	Box/Pa	M2/Pa	Kg/Pa
Ductile Relief 60x120 cm. 24"x48"	59,8x119,8x0,9 cm.	●	●	620	2	1,43	22,00	24	34,32	558

**WOOD
TRIBUTE
COLLECTION**

Niu
French Oak in Ceramics
Roble Frances en Cerámica

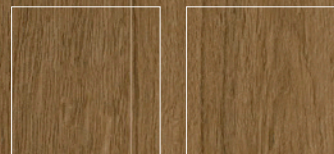

Soft Textured Finish Anti-slip Finish

Color Body Porcelain / Porcelánico Masa Coloreada
Rectified / Destonified V.3 / Rectificado / Destonificado V.3
N° Designs By Format / N° De Diseños Por Formato :
22,5x200: 32 / 22,5x160: 32 / 20x120: 33

3D-Fit®
Technology

Niu Autumn
Soft Textured Finish
Escala 1/3

Available Sizes / Formatos Disponibles

Step Tile & Countertops Availables. Consult Special Pieces Section.
Peldaños y Encimeras disponibles. Consulte la Sección de Piezas Especiales.



20x120x0,9 cm.
8"x48"



22,5x160x0,9 cm.
9"x63"



22,5x200x0,9 cm.
9"x79"

Complements / Complementos



Mosaic 330
Net 12"x12"
Malla 30x30 cm.
Real 29,8x29,8 cm.

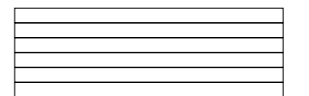

Mosaic 590
Net 12"x36"
Malla 30x90 cm.
Real 29,8x89,8 cm.

Available Colours / Colores Disponibles



Niu Sand Niu Canella Niu Light Walnut Niu Autumn

Porcelain Tiles Available Sizes & Finishes / Formatos y Acabados Disponibles en Porcelánico

Nominal Size Formato Nominal	Real Size Formato Real	Soft Textured C2 · R10 · CB	Anti-Slip C3 · R11	Price Code	Pz/Box	M2/Box	Kg/Box	Box/Pa	M2/Pa	Kg/Pa
20x120 cm. 8"x48"	19,8x119,8x0,9 cm.	●	●	20	5	1,19	25,15	45	53,55	1165
22,5x160 cm. 9"x63"	22,3x159,8x0,9 cm.	●		23	3	1,06	22,13	54	57,72	1230
22,5x200 cm. 9"x79"	22,3x199,8x0,9 cm.	●		22	3	1,33	27,69	42	56,14	1163
Mosaic 330	29,8x29,8x0,9 cm.	●		330	5	0,44	10,50	60	26,40	666
Mosaic 590	29,8x89,8x0,9 cm.	●		590	3	0,81	18,30	20	16,20	398

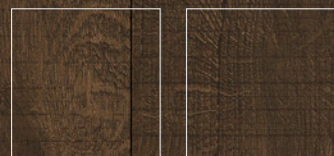

Soft Textured Finish Anti-slip Finish

Color Body Porcelain / Porcelánico Masa Coloreada
Rectified / Destonified V.3 / Rectificado / Destonificado V.3
N° Designs By Format / N° De Diseños Por Formato :
22,5x200: 32 / 22,5x160: 32 / 20x120: 33

3D-Fit®
Technology

Ombra Cocoa
Soft Textured Finish
Escala 1/3

Available Sizes / Formatos Disponibles

Step Tile & Countertops Availables. Consult Special Pieces Section.
Peldaños y Encimeras disponibles. Consulte la Sección de Piezas Especiales.



20x120x0,9 cm.
8"x48"



22,5x160x0,9 cm.
9"x63"



22,5x200x0,9 cm.
9"x79"

Complements / Complementos



Mosaic 330
Net 12"x12"
Malla 30x30 cm.
Real 29,8x29,8 cm.

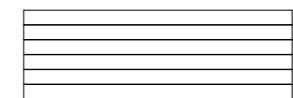

Mosaic 590
Net 12"x36"
Malla 30x90 cm.
Real 29,8x89,8 cm.

Available Colours / Colores Disponibles



Ombra Sand Ombra Cognac Ombra Walnut Ombra Cocoa

Porcelain Tiles Available Sizes & Finishes / Formatos y Acabados Disponibles en Porcelánico

Nominal Size Formato Nominal	Real Size Formato Real	Soft Textured C2 · R10 · CB	Anti-Slip C3 · R11	Price Code	Pz/Box	M2/Box	Kg/Box	Box/Pa	M2/Pa	Kg/Pa
20x120 cm. 8"x48"	19,8x119,8x0,9 cm.	●	●	20	5	1,19	25,15	45	53,55	1165
22,5x160 cm. 9"x63"	22,3x159,8x0,9 cm.	●		23	3	1,06	22,13	54	57,72	1230
22,5x200 cm. 9"x79"	22,3x199,8x0,9 cm.	●		22	3	1,33	27,69	42	56,14	1163
Mosaic 330	29,8x29,8x0,9 cm.	●		330	5	0,44	10,50	60	26,40	666
Mosaic 590	29,8x89,8x0,9 cm.	●		590	3	0,81	18,30	20	16,20	398

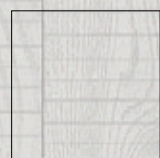
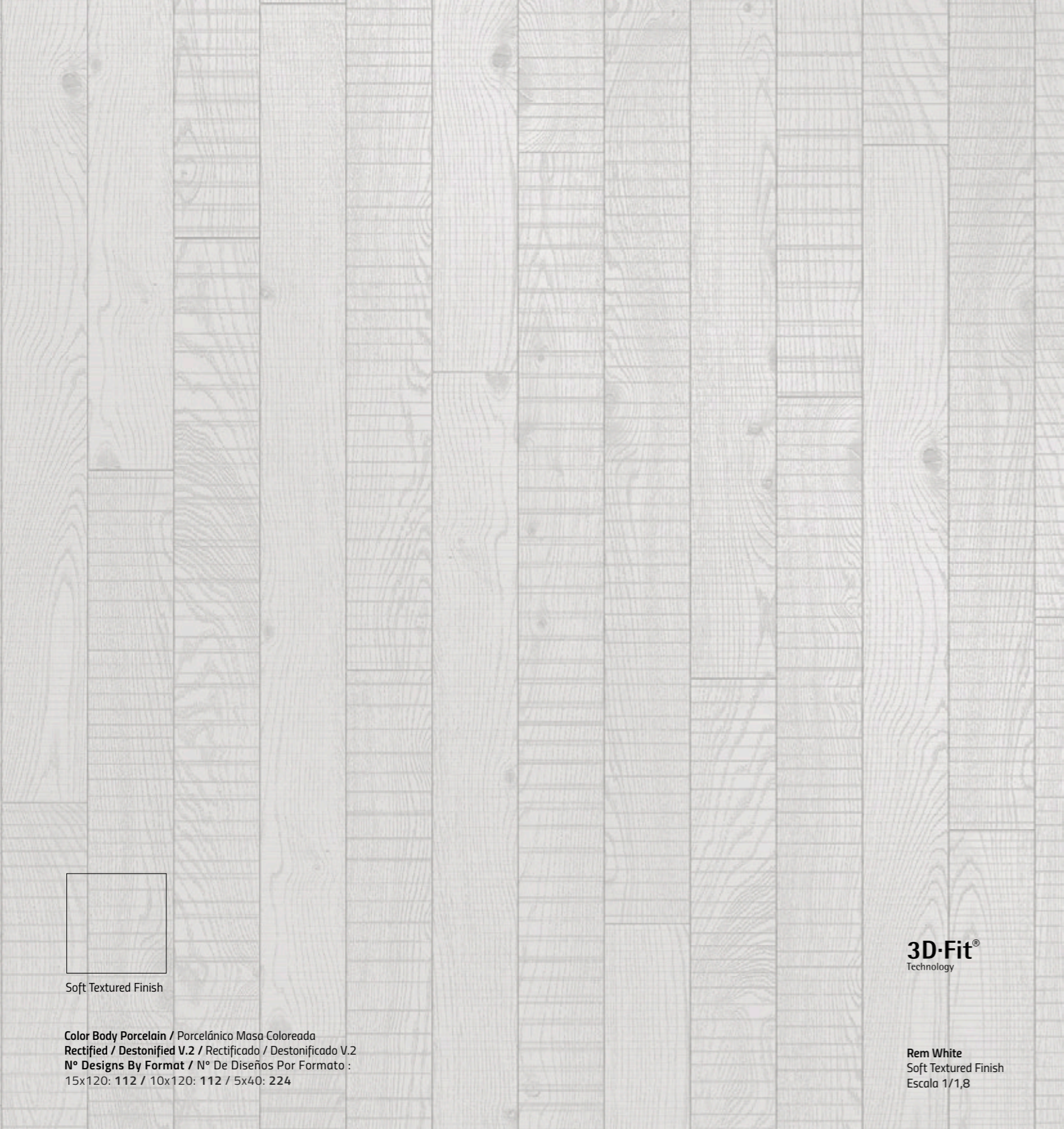

Soft Textured Finish

Color Body Porcelain / Porcelánico Masa Coloreada
Rectified / Destonified V.2 / Rectificado / Destonificado V.2
N° Designs By Format / N° De Diseños Por Formato :
15x120: 112 / 10x120: 112 / 5x40: 224

3D-Fit®
Technology

Rem White
Soft Textured Finish
Escala 1/1,8

Available Sizes / Formatos Disponibles



5x40x0,9 cm.
2"x16"



10x120x0,9 cm.
4"x48"

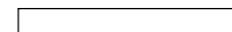

15x120x0,9 cm.
6"x48"

Available Colours / Colores Disponibles



Rem White



Rem Soft Grey

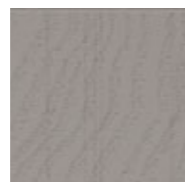

Rem Grey

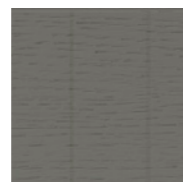

Rem Taupe



Rem Black

Porcelain Tiles Available Sizes & Finishes / Formatos y Acabados Disponibles en Porcelánico

Nominal Size Formato Nominal	Real Size Formato Real	Soft Textured C2 · R10 · CB	Price Code	Pz/Box	M2/Box	Kg/Box	Box/Pa	M2/Pa	Kg/Pa
5x40 cm. 2"x16"	4,8x39,8x0,9 cm.	●	6	50	0,95	19,77	50	47,5	989
10x120 cm. 4"x48"	9,8x119,8x0,9 cm.	●	19	9	1,057	21,87	48	43,2	1050
15x120 cm. 6"x48"	14,8x119,8x0,9 cm.	●	18	6	1,064	22,02	48	51,07	1057

**WOOD
TRIBUTE
COLLECTION**

Riga
Striped Wood in Ceramics
Madera Rayada Cerámica

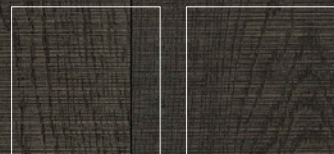

Soft Textured Finish Anti-slip Finish

Color Body Porcelain / Porcelánico Masa Coloreada
Rectified / Destonified V.3 / Rectificado / Destonificado V.3
N° Designs By Format / N° De Diseños Por Formato :
22,5x200: 28 / 22,5x160: 28 / 20x120: 33

3D-Fit®
Technology

Riga Taupe
Soft Textured Finish
Escala 1/3

Available Sizes / Formatos Disponibles

Step Tile & Countertops Availables. Consult Special Pieces Section.
Peldaños y Encimeras disponibles. Consulte la Sección de Piezas Especiales.



20x120x0,9 cm.
8"x48"



22,5x160x0,9 cm.
9"x63"



22,5x200x0,9 cm.
9"x79"

Complements / Complementos

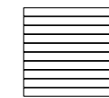

Mosaic 330
Net 12"x12"
Malla 30x30 cm.
Real 29,8x29,8 cm.

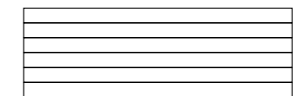

Mosaic 590
Net 12"x36"
Malla 30x90 cm.
Real 29,8x89,8 cm.

Available Colours / Colores Disponibles

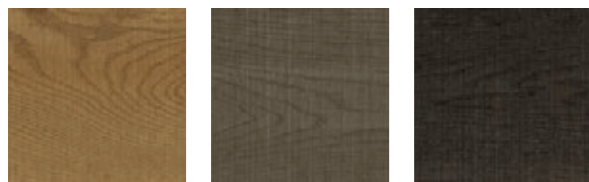

Riga Honey Riga Walnut Riga Taupe

Porcelain Tiles Available Sizes & Finishes / Formatos y Acabados Disponibles en Porcelánico

Nominal Size Formato Nominal	Real Size Formato Real	Soft Textured C2 · R10 · CB	Anti-Slip C3 · R11	Price Code	Pz/Box	M2/Box	Kg/Box	Box/Pa	M2/Pa	Kg/Pa
20x120 cm. 8"x48"	19,8x119,8x0,9 cm.	●	●	20	5	1,19	25,15	45	53,55	1165
22,5x160 cm. 9"x63"	22,3x159,8x0,9 cm.	●		23	3	1,06	22,13	54	57,72	1230
22,5x200 cm. 9"x79"	22,3x199,8x0,9 cm.	●		22	3	1,33	27,69	42	56,14	1163
Mosaic 330	29,8x29,8x0,9 cm.	●		330	5	0,44	10,50	60	26,40	666
Mosaic 590	29,8x89,8x0,9 cm.	●		590	3	0,81	18,30	20	16,20	398

**WOOD
TRIBUTE
COLLECTION**

Uno
Oak in Ceramics
Roble en Cerámica

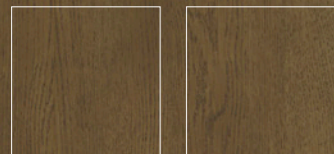

Soft Textured Finish Anti-slip Finish

Color Body Porcelain / Porcelánico Masa Coloreada
Rectified / Destonified V.3 / Rectificado / Destonificado V.3
N° Designs By Format / N° De Diseños Por Formato :
22,5x200: 24 / 22,5x160: 24 / 20x120: 39

3D-Fit®
Technology

Uno Cocoa
Soft Textured Finish
Escala 1/3

Available Sizes / Formatos Disponibles

Step Tile & Countertops Availables. Consult Special Pieces Section.
Peldaños y Encimeras disponibles. Consulte la Sección de Piezas Especiales.



20x120x0,9 cm.
8"x48"



22,5x160x0,9 cm.
9"x63"



22,5x200x0,9 cm.
9"x79"

Complements / Complementos



Mosaic 330
Net 12"x12"
Malla 30x30 cm.
Real 29,8x29,8 cm.

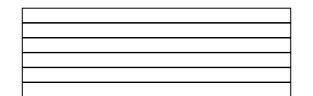

Mosaic 590
Net 12"x36"
Malla 30x90 cm.
Real 29,8x89,8 cm.

Available Colours / Colores Disponibles



Uno Sand

Uno Canella

Uno Cognac

Uno Walnut

Uno Cocoa

Uno Nightfall

Porcelain Tiles Available Sizes & Finishes / Formatos y Acabados Disponibles en Porcelánico

Nominal Size Formato Nominal	Real Size Formato Real	Soft Textured C2 · R10 · CB	Anti-Slip C3 · R11	Price Code	Pz/Box	M2/Box	Kg/Box	Box/Pa	M2/Pa	Kg/Pa
20x120 cm. 8"x48"	19,8x119,8x0,9 cm.	●	●	20	5	1,19	25,15	45	53,55	1165
22,5x160 cm. 9"x63"	22,3x159,8x0,9 cm.	●		23	3	1,06	22,13	54	57,72	1230
22,5x200 cm. 9"x79"	22,3x199,8x0,9 cm.	●		22	3	1,33	27,69	42	56,14	1163
Mosaic 330	29,8x29,8x0,9 cm.	●		330	5	0,44	10,50	60	26,40	666
Mosaic 590	29,8x89,8x0,9 cm.	●		590	3	0,81	18,30	20	16,20	398



White Body / Pasta Blanca
Non Rectified / Destonified V.2 / No Rectificado / Destonificado V.2
N° Designs By Format / N° De Diseños Por Formato : 7,5x30: 2 / 7,5x15: 4

Mayolica Soft Grey
Glossy Finish
Graphic Scale 1/2,7

Available Sizes / Formatos Disponibles



7,5x30 cm.
3"x12"



7,5x15 cm.
3"x6"

Placement Proposals / Propuestas de Colocación

7,5x15 cm.
3"x6"

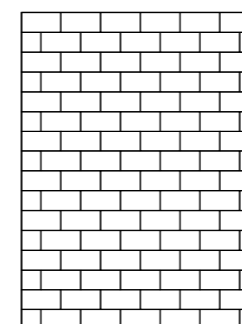

7,5x15 cm.
3"x6"

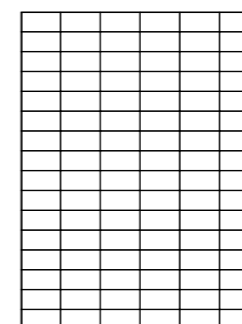

7,5x30 cm.
3"x12"

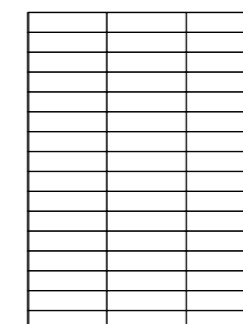

7,5x30 cm.
3"x12"

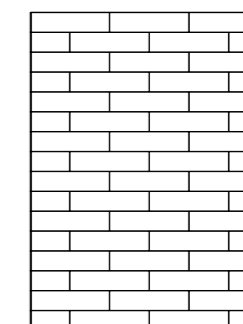

Available Colours / Colores Disponibles

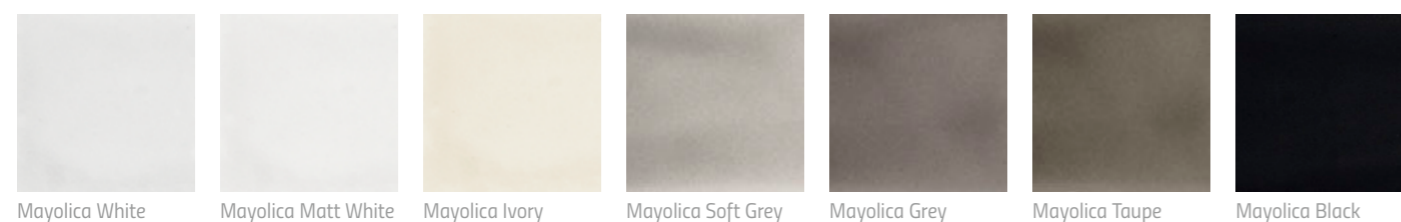

Mayolica White Mayolica Matt White Mayolica Ivory Mayolica Soft Grey Mayolica Grey Mayolica Taupe Mayolica Black

Wall Tiles Available Sizes & Finishes / Formatos y Acabados Disponibles en Revestimientos Cerámicos

Nominal Size Formato Nominal	Real Size Formato Real	Glossy	Price Code	Pz/Box	M2/Box	Kg/Box	Box/Pa	M2/Pa	Kg/Pa
P.B. 7,5x15 cm. 3"x6"	7,5x15 cm.	●	7	44	0,50	7,04	120	60,00	880
P.B. 7,5x30 cm. 3"x12"	7,5x30 cm.	●	7	22	0,50	6,60	120	60,00	828



SIGNATURE SURFACES

The passion we feel at *Living* for good design has resulted in Signature Surfaces. This line comes from the union, from the fusion between the creative talent of great designers and their way of interpreting ceramics, joint with our desire of contributing in the world of interior design and architecture giving unique cutting edge ceramic solutions.

The ending of this collaboration is untold pieces with innovative finishes and textures that grant an exclusive identity to the creation. The personality of the result makes the difference, from the elegance, beauty and sobriety that define us.

La pasión que sentimos en *Living* por el buen diseño ha dado lugar a Signature Surfaces. Esta línea nace de la unión, de la fusión entre el talento creativo de grandes diseñadores y su modo de interpretar la cerámica, junto con nuestro deseo de contribuir en el mundo del interiorismo y la arquitectura aportando soluciones cerámicas únicas de estilo vanguardista. El desenlace de esta colaboración son piezas inéditas con acabados y texturas innovadoras que conceden a la creación una identidad exclusiva. La personalidad del resultado marca la diferencia, desde la elegancia, belleza y sobriedad que nos define.

Livingceramics



Nuer

by KensakuOshiro

Nuer investigates the function of the wall covering by separating the tile from its conception as a mere decorative element to extend it to the whole surface.

The tile is made up of the repetition of a module with three faces, each with its angle and color, designed to create interesting color gradations that blend depending on the point of view, the angle, and the distance of the observer. The size allow you to both tint huge surfaces and compose different chromatic effects of innovative dynamism.

Nuer profundiza en la función del revestimiento de pared, desprendiéndose del concepto del azulejo como puro elemento decorativo para extender este concepto a toda la superficie. El mosaico se compone de la repetición de un módulo con tres caras anguladas, cada una con un color, diseñadas para crear interesantes juegos de tonalidades que varían dependiendo del punto de vista, el ángulo y la distancia desde la que se observe. El formato en el que se producen las baldosas permiten fusionar grandes superficies o crear composiciones y juegos cromáticos de dinamismo innovador.

Kensaku Oshiro

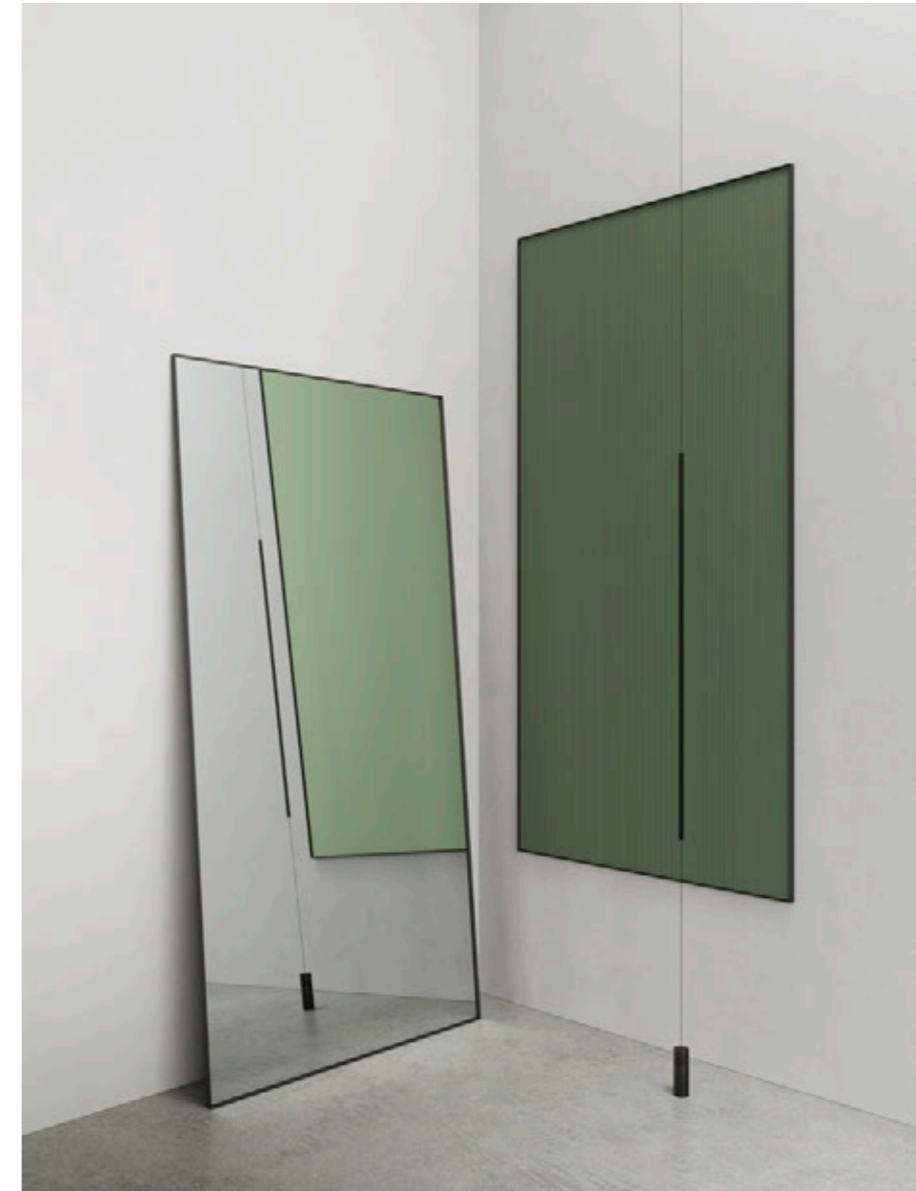

Nuer Moss 60x120 (24"x48")



SIGNATURE SURFACES

140

Thanks to the precision of Livingceramics' digital printing technology applied to the three-dimensional design of this tile, it is possible to reproduce the soft shades and combinations of colors inspired by nature, thereby designing a connection between interior and exterior enhancing the quality of the space.

Gracias a la precisión de la tecnología de impresión digital de Livingceramics aplicada al diseño tridimensional de esta baldosa, es posible reproducir bellas tonalidades y combinaciones de colores inspiradas en la naturaleza, creando así una conexión entre el interior y el exterior y mejorando la calidad del espacio.



Nuer Sunset 60x120 (24"x48")



Nuer by KensakuOshiro

141

Available Sizes / Formatos Disponibles

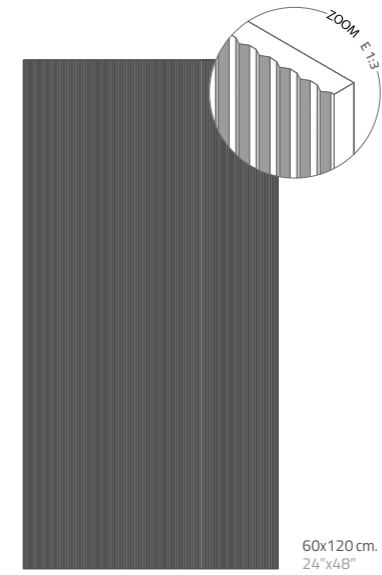

Technical Specifications / Especificaciones Técnicas

White Body / Pasta Blanca
 Non Rectified / Destonified V.0 / No Rectificado / Destonificado V.0
 N° Designs By Format / N° De Diseños Por Formato :
 60x120: 1



Design Collection / Diseño de la Colección

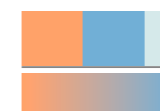

Sunset



Clay



Magic Hour



Sand



Moss



Marine

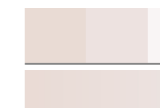

Quartz



Fog

Wall Tiles Available Sizes & Finishes / Formatos y Acabados Disponibles en Revestimiento

Nominal Size Formato Nominal	Real Size Formato Real	Natural Natural	Price Code	Pz/Box	M2/Box	Kg/Box	Box/Pa	M2/Pa	Kg/Pa
NUER 60x120 cm. 24"x48"	59,8x119,8x0,9 cm.	●	52	2	1,43	22	24	34,32	558



Bisel

by Víctor Carrasco

Bisel is the new collection designed by Víctor Carrasco for the Signature Surfaces series at Livingceramics. A collection which transmits the designer's way of conceiving interior design and architecture, drawing from the essential to create pleasant, elegant and inspiring spaces. With ideas designed by and for people.

The base is formed from an imaginary grid upon which the pieces are combined. They have two different surfaces: one smooth and one with a bevel along one of the piece's sides which creates a slightly oversized mosaic effect in the set. The combination of both pieces makes lines of different intensities on the surface, providing many composition possibilities. A collection open to ideas, creativity and diversity. And which reminds us that designing is investigating, experimenting and feeling. Enjoy the experience.

Bisel es la nueva colección que Víctor Carrasco ha diseñado para las series Signature Surfaces de Livingceramics. Una colección que transmite la manera de concebir el interiorismo y la arquitectura del diseñador, partiendo siempre de lo esencial para crear espacios amables, elegantes e inspiradores. Con ideas pensadas desde y para las personas.

La base se forma a partir de una cuadrícula imaginaria sobre la que combinar las piezas, que cuentan con dos superficies distintas: una lisa y una con un bisel a lo largo de uno de los laterales de la pieza que crea un efecto de mosaico ligeramente sobredimensionado en el conjunto. La combinación de ambas piezas forma líneas de diferentes intensidades en la superficie, aportando muchas posibilidades de composición. Una colección abierta a las ideas, a la creatividad y la diversidad. Y a que recordemos que diseñar es investigar, experimentar y sentir. Disfruta de la experiencia.

Víctor Carrasco



Two different pieces for infinite combinations

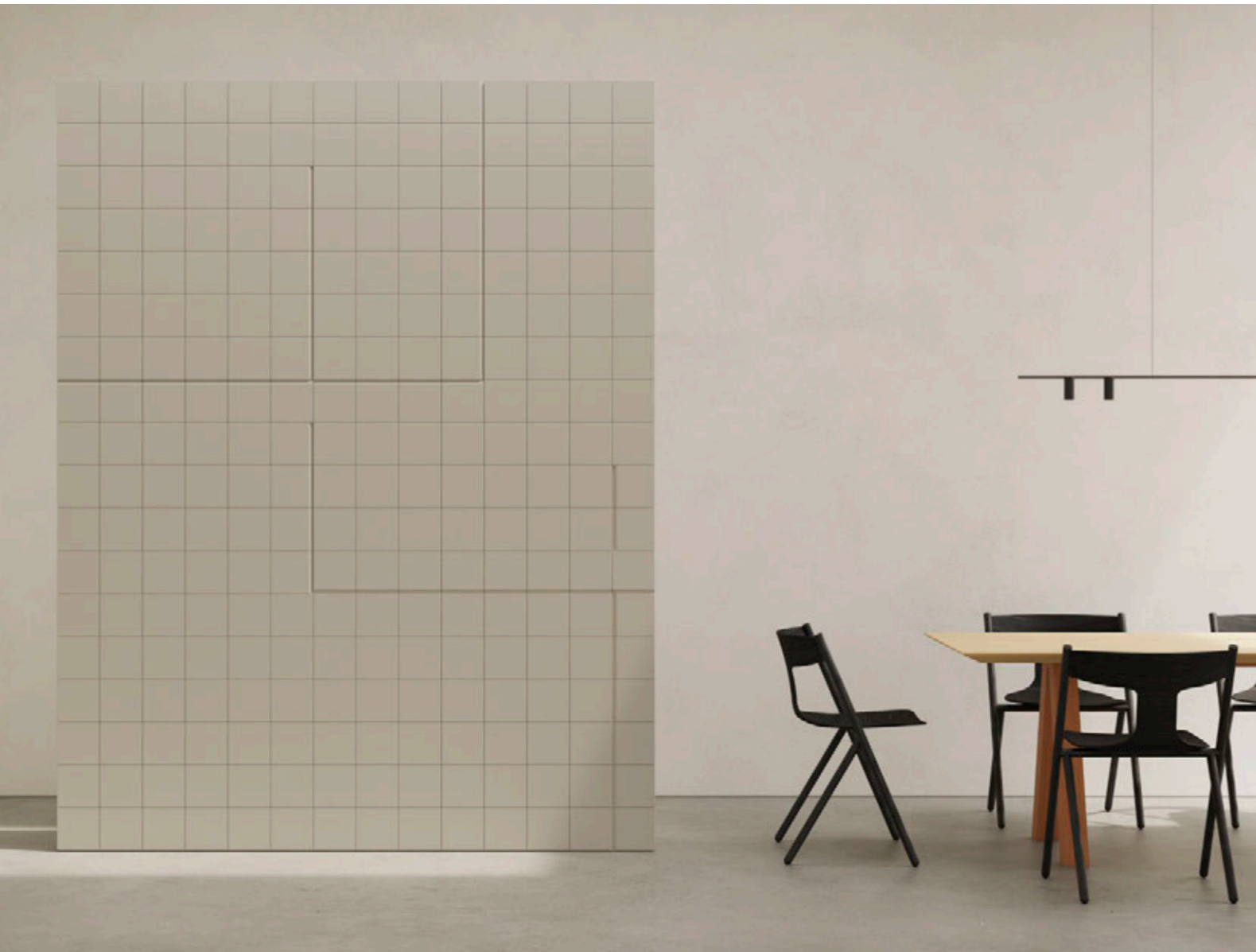

Bisel Linen 15x15 cm. (6"x6")

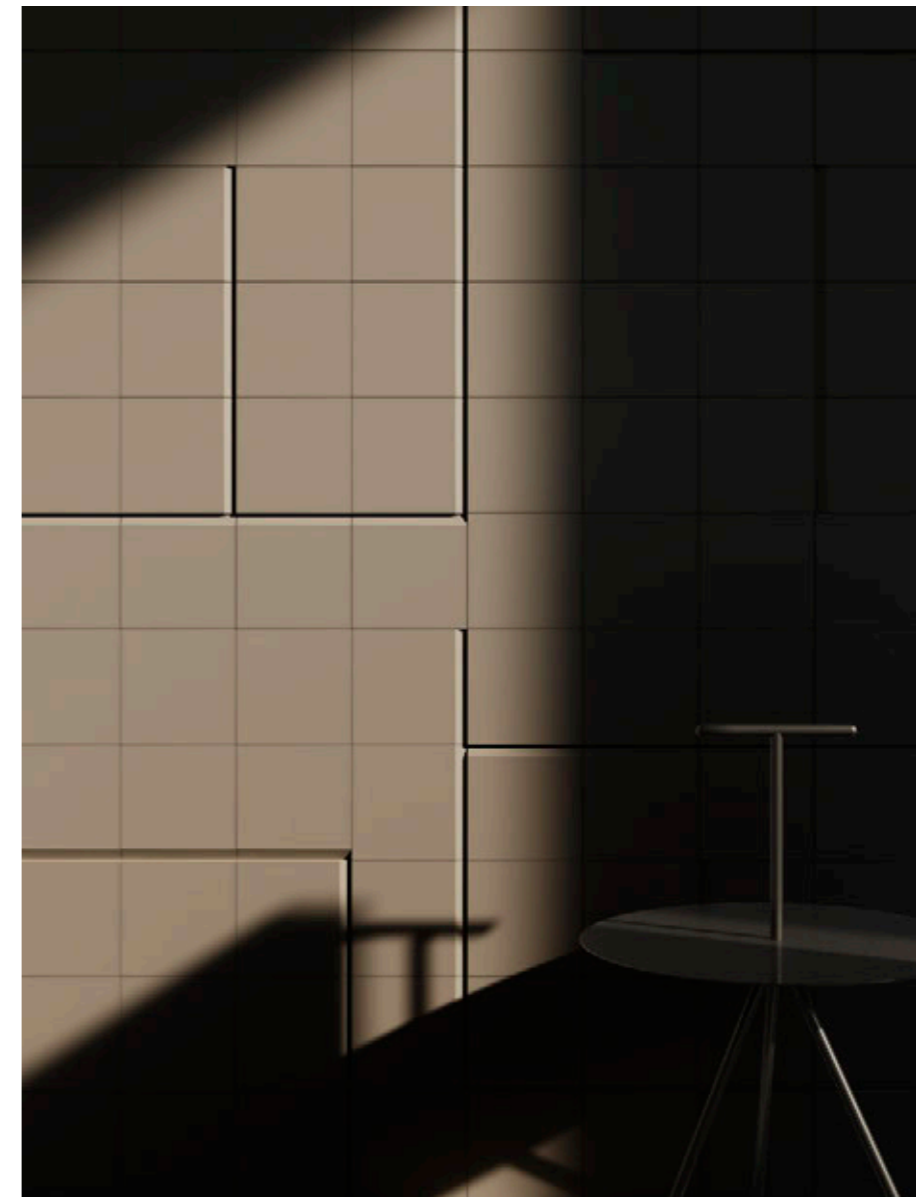

Bisel Pietra 15x15 cm. (6"x6")

Thus Bisel, a collection which showcases the idea as a fundamental part of the design, came into existence. The power of a pencil and a blank sheet of paper, the process of thinking and exploring as the origin of everything which is to come. That enthusiasm and enjoyment one feels when starting a project, which should never be forgotten.

In Bisel, everything is still unwritten. As a starting point: a format, two surfaces and seven colours which will help you think beyond, giving shape to ideas and creating innovative compositions. An apparently simple proposal originating from a deep reflection on our behaviour and interaction with the space. A differentiation tool so that from my side I leave 50% of the design on the table, with the user completing the other 50% with their choice.

Así nace Bisel, una colección que ensalza a la idea como parte fundamental del diseño. El poder de la hoja en blanco y el lápiz, el proceso de pensar y explorar como origen de todo lo que vendrá después. Ese entusiasmo y disfrute que se siente al iniciar un proyecto y que no debería olvidarse jamás.

En Bisel aún no hay nada escrito. Como punto de partida, un formato, dos superficies y siete colores que te ayudarán a pensar más allá, dar forma a las ideas y crear composiciones novedosas. Una aparente simple propuesta nacida de una profunda reflexión sobre nuestro comportamiento e interacción con el espacio. Una herramienta de diferenciación en la que Víctor Carrasco deja sobre la mesa el 50% del diseño siendo el usuario quien complete el otro 50% a su elección.

Technical Specifications / Especificaciones Técnicas

White Body / Pasta Blanca
 Non Rectified / Destonified V.0 / No Rectificado / Destonificado V.0
 N° Designs By Format / N° De Diseños Por Formato:
 15x15: 1



Design Collection / Diseño de la Colección

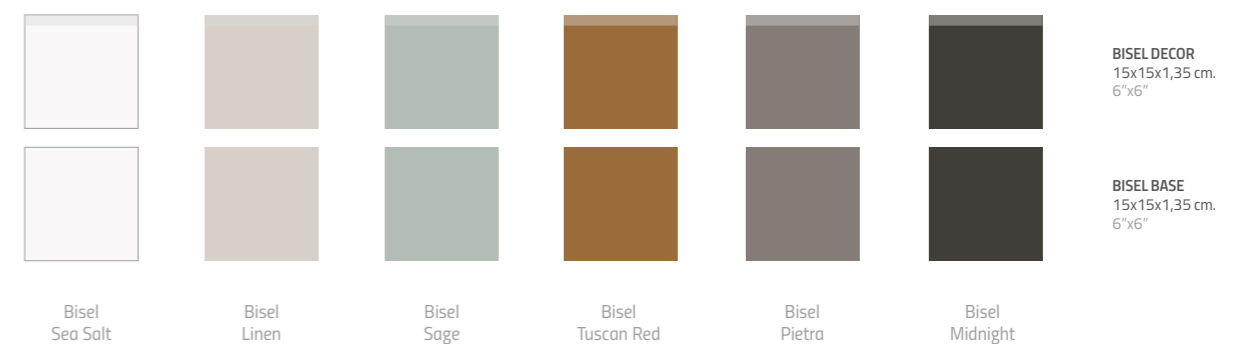

Wall Tiles Available Sizes & Finishes / Formatos y Acabados Disponibles en Revestimiento

Nominal Size Formato Nominal	Real Size Formato Real	Natural Natural	Price Code	Pz/Box	M2/Box	Kg/Box	Box/Pa	M2/Pa	Kg/Pa
BISEL DECOR 15x15 cm. 6"x6"	15x15x1,35 cm.	●	51	16	0,36	7,85	120	43,2	942
BISEL BASE 15x15 cm. 6"x6"	15x15x1,35 cm.	●	51	16	0,36	7,85	120	43,2	942

Balance

by Víctor Carrasco

The incidence of light is represented in the different formats, creating a certain relationship between the combination of the different pieces and finishes. Luminosity and opacity are reflected in this collection, these are brought together and supplement one another through their contrasting yet connecting tonalities.

In the Balance collection all of the superfluous and redundant elements have been eliminated and the pieces which make up this collection are defined by their exquisite design, which represents both the heart and soul of the light; an element which despite being so simple, brings great value to the space it complements. Through its well-thought out study of gradients, this collection looks to reflect the real power of this piece, using intensity to turn it into a truly unique element.

La colección Balance es un sutil ejercicio de iluminación sobre cuidados materiales creando un collage de sinuosas luces y sombras. Atemporal y sorpresiva, Balance nace para crear espacios nobles. La elegancia se aprecia entre las luces y sombras con una gran sutileza; reflejando su paso a través de la pieza, se consigue un acabado sutil y natural.

La incidencia de la luz se representa en los diferentes formatos, creando una relación y complementación entre la combinación de las diferentes piezas y acabados. Se refleja la luminosidad y la opacidad, uniéndose y complementándose mediante tonalidades que contrastan y se relacionan a su vez.

Balance elimina elementos superfluos y redundantes, definiendo unas piezas con un diseño exquisito que representan la esencia y el alma de la luz. Un elemento tan simple, pero que a su vez añade un gran valor, al espacio que complementa. Su poder se ha querido reflejar mediante una estudiada representación de degradados, transmitiendo el juego de su intensidad que convierte una pieza en un elemento único.

Víctor Carrasco

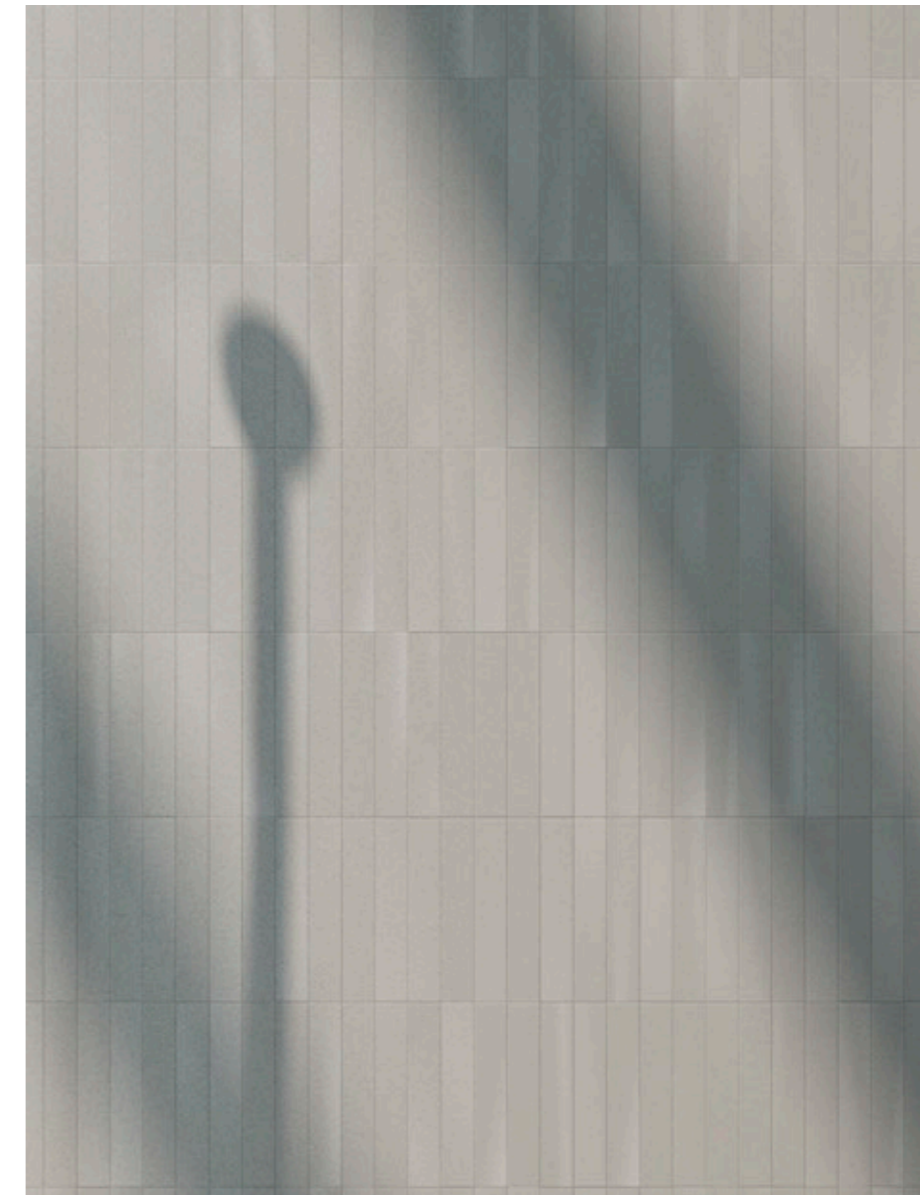

Balance Pavilion Grey 5x30 cm. (2"x12")



Balance by Víctor Carrasco

151

In architectural design, importance has always been placed on letting light reach where it is needed most. Light becomes the protagonist of the piece, enabling shadows to emerge, reflecting a mixture of light and dark tonalities and textures. A certain poetry is reflected and defined through these contrasts, highlighting every individual detail in this dance of shadows.

Desde los inicios de la arquitectura la conducción de la luz hacia donde más se necesitaba ha sido una prioridad ante cada nuevo proyecto. La luz se convierte en la protagonista, representando su papel principal, nacen sombras que reflejan un juego entre tonalidades, claroscuros y texturas. La poesía se refleja y define mediante contrastes, realzando cada detalle y estableciendo un baile de sombras.

Technical Specifications / Especificaciones Técnicas

Color Body Porcelain / Porcelánico Masa Coloreada
 Rectified / Destonified V.4 / Rectificado / Destonificado V.4
 Nº Designs By Format / Nº De Diseños Por Formato :
 5x15: 56 / 5x30: 28 / 10x10: 55

Design Collection / Diseño de la Colección

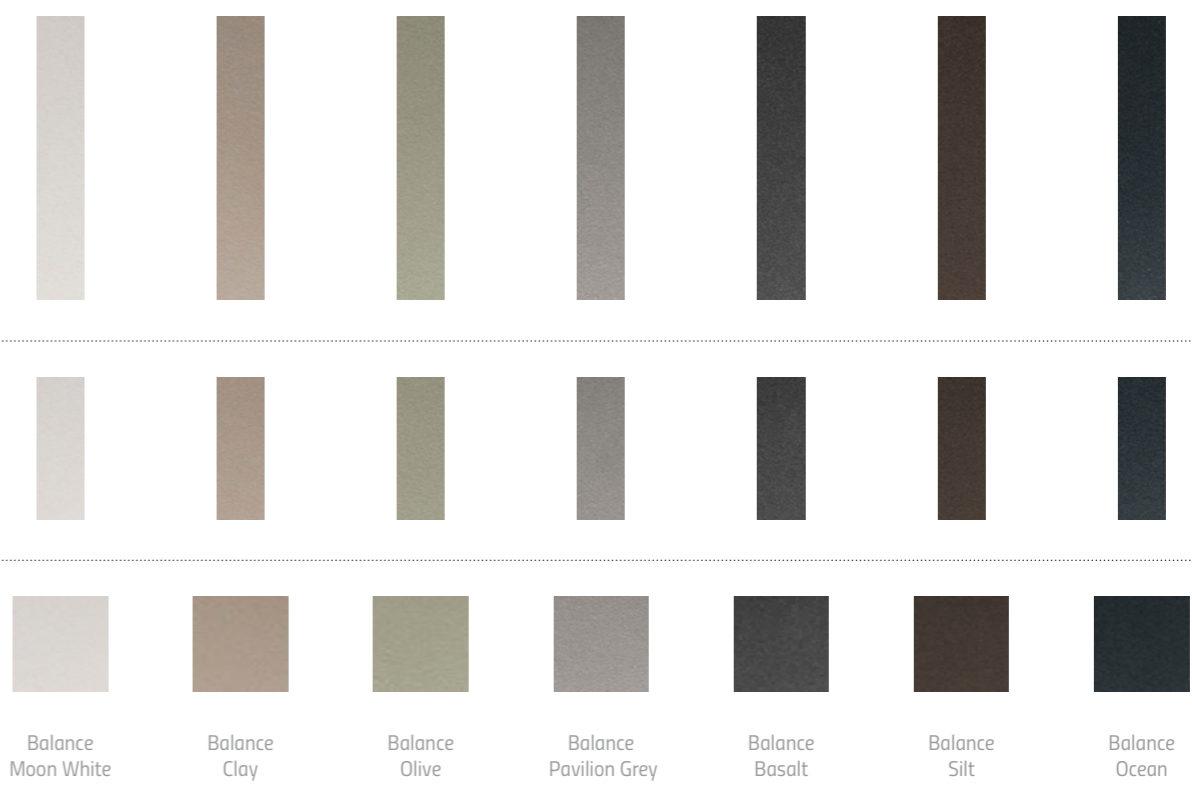

Balance Basalt 5x15 cm. (2"x6")

Porcelain Tiles Available Sizes & Finishes / Formatos y Acabados Disponibles en Porcelánico

Nominal Size Formato Nominal	Real Size Formato Real	Natural Natural C1 · R9 · CA	Price Code	Pz/Box	M2/Box	Kg/Box	Box/Pa	M2/Pa	Kg/Pa
5x15 cm. 2"x6"	4,8x14,8x0,9 cm.	●	50-1	60	0,43	9,60	60	25,80	612
5x30 cm. 2"x12"	4,8x29,8x0,9 cm.	●	50-2	30	0,43	9,60	60	25,80	612
10x10 cm. 4"x4"	9,8x9,8x0,9 cm.	●	50-3	45	0,43	9,60	60	25,80	612

Cava

by LucidiPevere

Cava is the new collection designed by the Italian studio LucidiPevere, it arises from a mix of formats, decorations engraved on the piece and a play with the color scheme. Combining recorded and flat surfaces endless compositions are born. It is not until the installation of the chosen color joint is completed, that the collection takes sense: real leaks and mixed engravings are confused resulting in the final decoration >. LP

Cava es la nueva colección diseñada por el estudio italiano LucidiPevere, surge de una mezcla de formatos, decoraciones grabadas sobre la pieza y un juego con las combinaciones de colores. De la combinación de superficies grabadas y lisas nacen infinitas posibilidades de composición. No es hasta que se completa la instalación con la junta de color escogida, cuando la colección cobra el sentido completo: fugas reales y grabados que se mezclan y confunden dando lugar a la decoración final >. LP

LucidiPevere

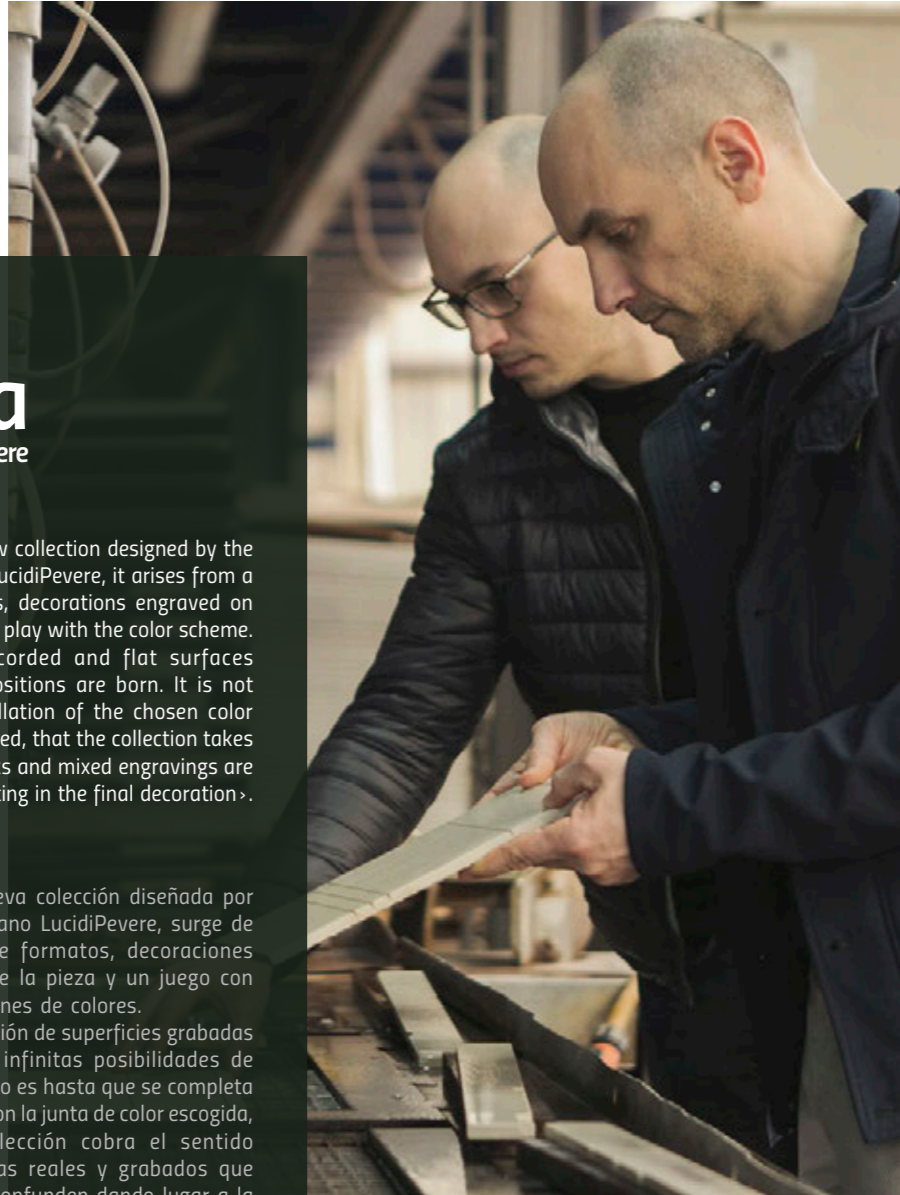

Luca Pevere & Paolo Lucidi



Cava Brown 15.B + J · Turquoise



Cava Mosaic Beige. E + J. Tierra de Siena

Technical Information / Información Técnica

Color Body Porcelain / Porcelánico Masa Coloreada
 Rectified / Destonified V.2 / Rectificado / Destonificado V.2
 N° Designs By Format / N° De Diseños Por Formato :
 90x90: 3 / 45x90: 6 / 60x60: 3 / 30x60: 6 / 10x60: 18 / 15x30: 24 / 7,5x30: 48 / 13x15: 48



Available Colours / Colores Disponibles

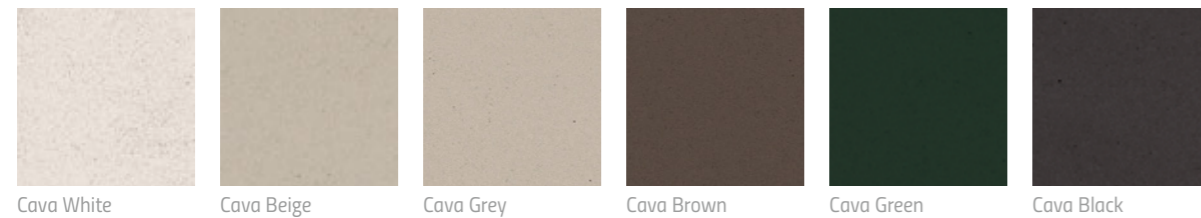

Cava Graphic Patterns / Patrones Gráficos Cava

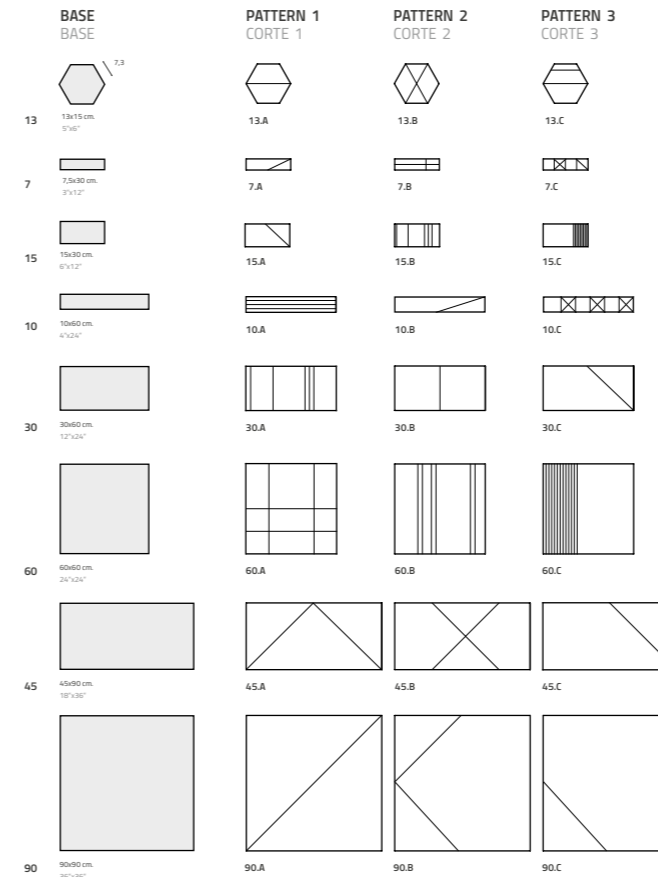

Cava Mosaic Graphic Patterns / Patrones Gráficos Cava Mosaic

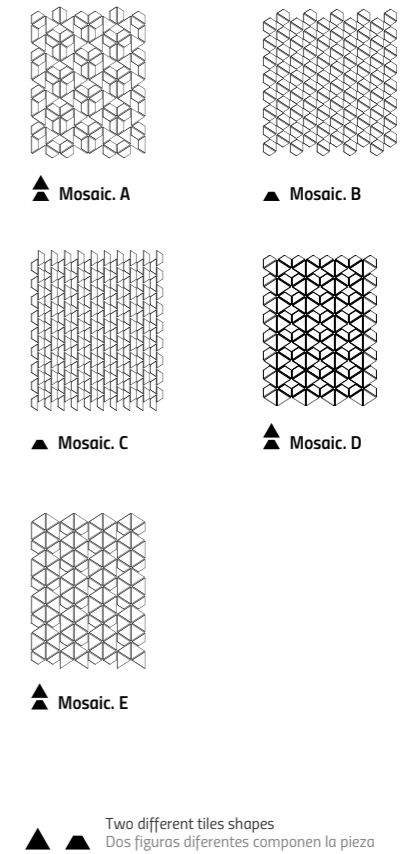

Porcelain Tiles Available Sizes & Finishes / Formatos y Acabados Disponibles en Porcelánico

Nominal Size Formato Nominal	Real Size Formato Real	Natural Natural C1 · R9 · CA	Price Code	Pz/Box	M2/Box	Kg/Box	Box/Pa	M2/Pa	Kg/Pa
13x15 cm. 5"x6"	12,6x14,6x0,9 cm.	●	11	24	0,33	8,40	60	19,96	540
7,5x30 cm. 3"x12"	7,3x29,8x0,9 cm.	●	12	24	0,52	11,52	60	31,33	703
15x30 cm. 6"x12"	14,8x29,8x0,9 cm.	●	13	12	0,53	11,76	60	31,75	742
10x60 cm. 4"x24"	9,8x59,8x0,9 cm.	●	14	10	0,59	13,30	60	35,40	837
30x60 cm. 12"x24"	29,8x59,8x0,9 cm.	●	30	6	1,07	22,74	40	42,80	940
60x60 cm. 24"x24"	59,8x59,8x0,9 cm.	●	60	3	1,07	23,22	40	42,91	962
45x90 cm. 18"x36"	44,8x89,8x0,9 cm.	●	45	3	1,21	25,50	32	38,62	849
90x90 cm. 36"x36"	89,8x89,8x0,9 cm.	●	90	2	1,62	40,00	27	43,74	1100
Cava Mosaic. A.	22,8x27,8x0,9 cm.	●	20-1	5	0,31	9,00	60	19,02	565
Cava Mosaic. B.	27,5x29,6x0,9 cm.	●	20-2	5	0,40	9,00	60	24,42	565
Cava Mosaic. C.	29,5x29,9x0,9 cm.	●	20-3	5	0,44	9,00	60	26,46	565
Cava Mosaic. D.	22,8x27,1x0,9 cm.	●	20-4	5	0,30	9,00	60	18,54	565
Cava Mosaic. E.	22,8x27,8x0,9 cm.	●	20-5	5	0,31	9,00	60	19,02	565

CONTEMPORARY MIXTURES SURFACES

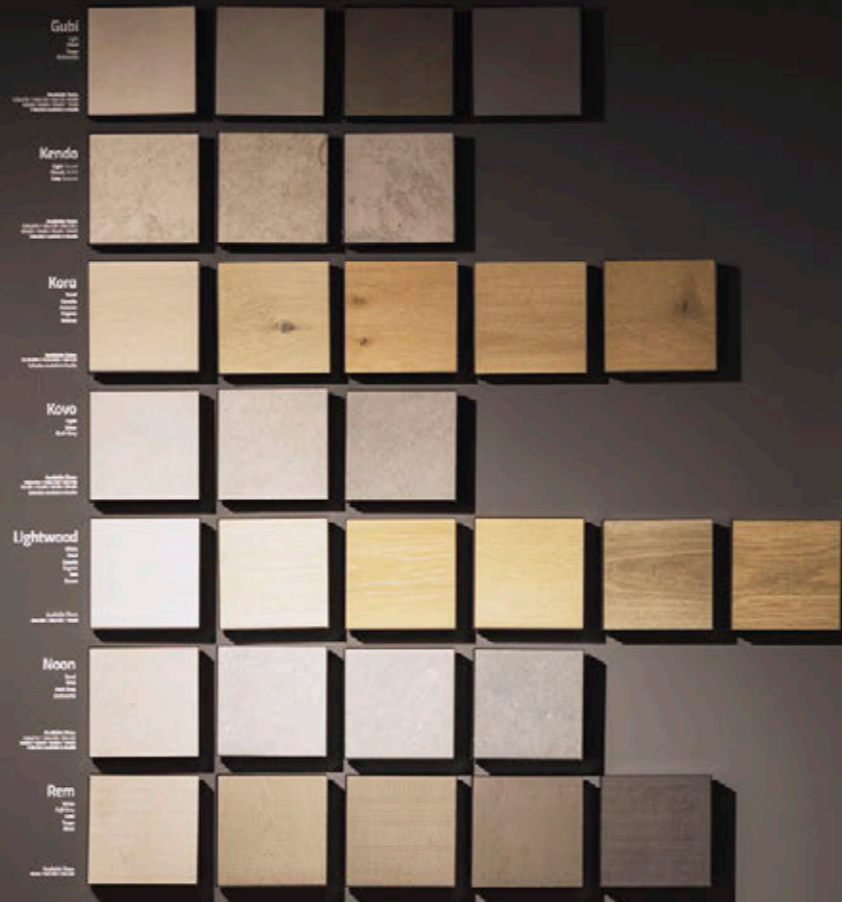
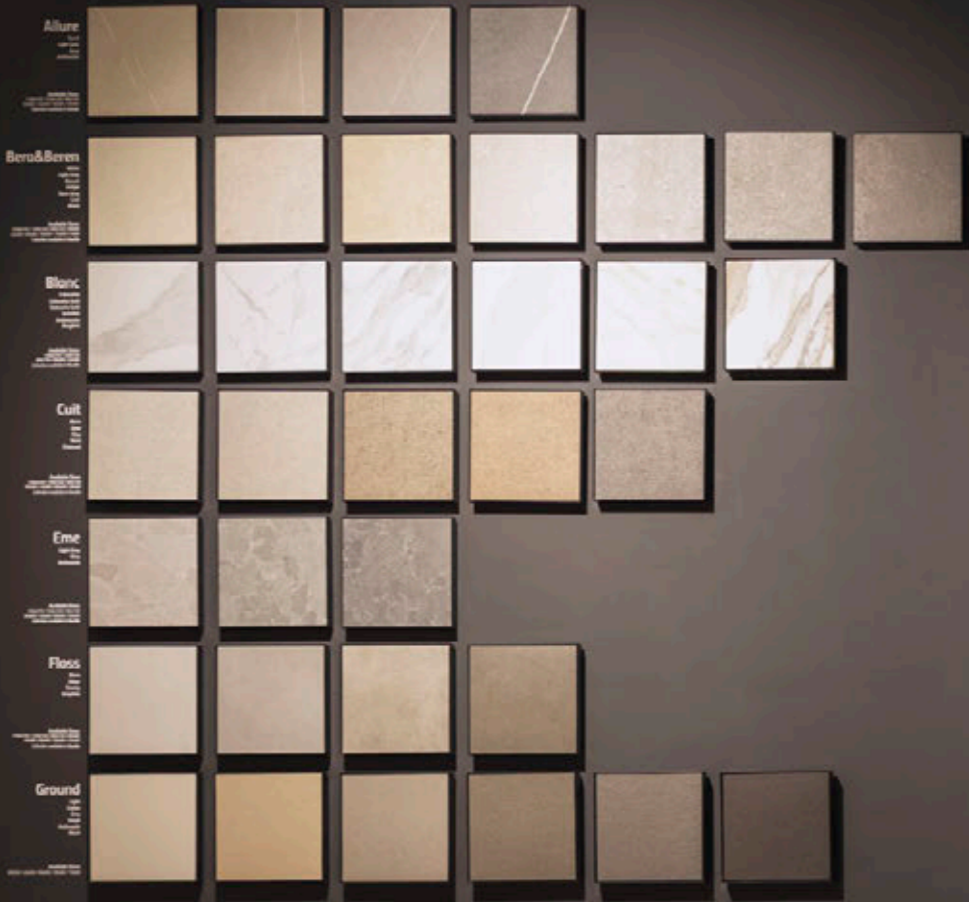

SIGNATURE SURFACES



DISCOVER OUR SHOWROOM

We are non-conformists with a passion for detail and determined to achieve optimum results in everything we do. We believe that the best way of demonstrating our work is to share what we feel with you, which is why our head offices include a space that reflects the true character of our brand. These pages will take you on a tour of our Showroom; our home is ready to welcome you, so enjoy the visit and find out how ceramic tile architecture became our true passion and vocation. Welcome to Livingceramics.

Somos inconformistas, nos gustan los detalles e insistimos con el fin de obtener un resultado óptimo en todo lo que hacemos. Pensamos que la mejor manera de demostrar nuestro trabajo es que lo sientas como nosotros, por eso, en nuestras oficinas centrales, tenemos una muestra del carácter que respira la marca. En estas páginas, te invitamos a entrar en nuestro Showroom, nuestra casa se abre para recibirte, así que disfruta del paseo y descubre cómo la arquitectura cerámica se ha convertido en nuestra pasión. Bienvenido a Livingceramics.



PLAY THE VIDEO

Livingceramics

20MM Thickness Floor

20mm. Porcelain Tiles

Porcelánico en 20mm.

Extra-thick porcelain tiles offer numerous benefits, thanks to their versatility and high resistance. These are properties fully able to meet the tough technical demands and aesthetic requirements of outdoor spaces, public areas, and places subject to high loads or stresses.

The tiles can be used in false floor systems, creating raised access flooring that provides easy access to plumbing and electricity networks. They are swift and easy to lay, and the perfect choice for outdoor areas.

El gres porcelánico espesorado ofrece múltiples ventajas gracias a su elevada resistencia y versatilidad. Características que responden a las más altas exigencias a nivel técnico y estético que requieren zonas de exterior, áreas públicas y zonas sometidas a altas cargas y tensiones.

Permite su ejecución en sistemas registrables, ofreciendo suelos técnicos elevados fácilmente accesibles a instalaciones de fontanería y electricidad. Rápido y fácil en su ejecución, se trata de un material perfecto para el pavimentado de exteriores.

Allure

Marbled Stone in Ceramics
Piedra Veteada Cerámica



Bera&Beren

Lusitan & Catalan Limestone Ceramics
Caliza Lusitana & Catalana Cerámica

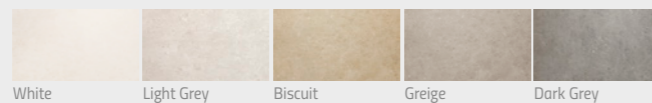

Eme

Mediterranean Stone in Ceramics
Piedra mediterránea Cerámica

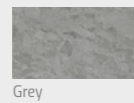

Gubi

Microcement Ceramics
Microcemento Cerámico

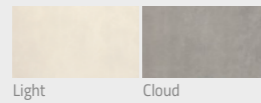

Kendo

Jura Stone in Ceramics
Piedra Jura en Cerámica

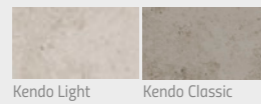

Kovo

Mixed Concrete in Ceramics
Mezcla de Cementos en Cerámica

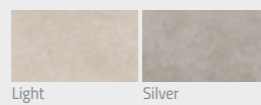

Noon

Northern Stone in Ceramics
Piedra del Norte Cerámica

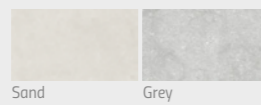

Verso Vein Cut

Travertine Stone in Ceramics
Piedra Travertino en Cerámica

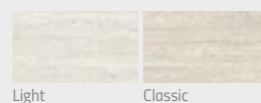

Verso Cross Cut

Travertine Stone in Ceramics
Piedra Travertino en Cerámica

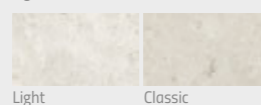

Vonn

Textured Stone in Ceramics
Piedra Texturada en Cerámica

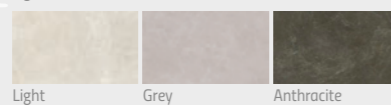

Our 20mm-thick collections can be used both indoors and out, ensuring seamless visual continuity. This is a definite asset in the design of spaces for residential, leisure or public use.

Nuestras colecciones de 20mm ofrecen la posibilidad de emplear el mismo material tanto en la zona interior como en la exterior, haciendo desaparecer los límites entre áreas y ofreciendo así continuidad visual al espacio. Una cualidad muy valorada a la hora de diseñar espacios como residenciales, zonas de ocio o espacios públicos.

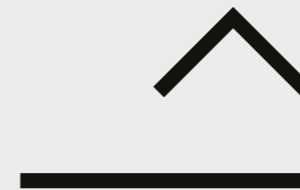

Thanks to the high resistance and inalterability of our 20mm-thick porcelain tiles, they are ideal for places subject to adverse conditions and extreme temperatures, such as covered terraces, gardens or patios.

Las cualidades técnicas de resistencia e inalterabilidad que presenta el gres porcelánico de 20mm lo hacen idóneo para revestir las áreas más expuestas a condiciones adversas: zonas de exterior como porches, jardines o terrazas en las que las temperaturas extremas inciden de manera directa.



All our 20mm-thick tile series are non-slip, guaranteeing a safe grip in wet areas or places close to water, such as poolside terraces. Likewise, the tiles are non-porous; that is, they do not absorb water and so they will not crack. What is more, they do not require any kind of special treatment.

Todas nuestras series disponibles en 20mm cuentan con acabado anti slip, destinado a garantizar la seguridad en zonas húmedas o cercanas al agua, como los bordes de las piscinas. Asimismo, al tratarse de un material no poroso, no absorbe agua y, por tanto, no se agrieta y no requiere de tratamientos específicos.



In order to ensure visual continuity between indoor and outdoor areas and to fit in with the needs of each individual project, extra-thick special porcelain tile pieces are available, such as step tiles, skirting tiles, corner tiles and finishing pieces. The range's high versatility contributes to projects' visual coherence.

Con el fin de mantener la continuidad estética entre los espacios interiores y exteriores y adaptarse a cada proyecto, el gres porcelánico espesorado se utiliza en piezas especiales como peldaños, zócalos, ángulos y remates cerámicos. La elevada versatilidad del material facilita la coherencia visual en el resultado final del proyecto.

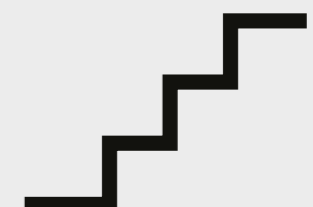

CONTEMPORARY CERAMIC SURFACES

160

Dimensions Dimensiones

Our thickened porcelain is available in the 90x90cm and 120x120cm formats.
Nuestro porcelánico espesorado está disponible en los formatos de 90x90cm y 120x120cm.

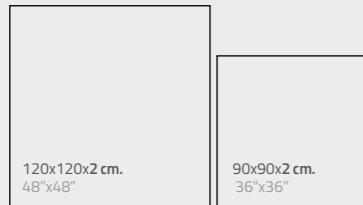

Breaking Strength		Resistencia a la Flexión
Breake Resistance		Resistencia a la Rotura
Waterproof Material		Material Impermeable
UV Resistant		Resistencia a los Rayos UV
Frost Resistant		Resistencia a la Climas Extremos
Resistant to Chemical Agents and Detergents		Resistencia a los Agentes Químicos y Detergentes
Easy to Clean		Fácil Limpieza
Reusable and Accesible		Registrable y Reutilizable
Fast Installation		Rápida Colocación
Easy to Install		Fácil Instalación
Colour Stability		Estabilidad Cromática

20MM THICKNESS

161

Pedestals Installation Example
Ejemplo de Instalación sobre Plots



ON PEDESTALS

Our 20mm-thick tiles can be rested on pedestals to create raised-access flooring (RAF). This swift, adhesive-free installation system allows networks to be concealed under the floor, such as wiring or pipes. Used in conjunction with conventionally laid tile surfaces and thanks to the large formats that Livingceramics offers, visual continuity can be ensured; for instance, to create terraces or in projects for the contract market.

SOBRE PLOTS

La instalación del porcelánico espesorado 20mm. sobre plots, crea un sistema de Suelo Técnico Elevado (STE) que permite una instalación libre de adhesivos, de ejecución rápida y con la ventaja de poder realizar una instalación bajo el pavimento, capaz de albergar cableado o tuberías. Junto con el sistema tradicional, y gracias al gran formato ofrecido por Livingceramics, permite instalaciones de una continuidad visual óptima en terrazas y proyectos contract.

CONVENTIONAL TILE-LAYING SYSTEMS

This is the most common system for creating flooring able to withstand high pedestrian traffic or moving vehicles in garages or up and down entrance ramps. The tiles are laid in a similar way to standard porcelain floor tiles, although the necessary joints for outdoor areas must be inserted.

SISTEMA TRADICIONAL

Es la instalación más normalizada para conseguir un sistema capaz de absorber grandes tránsitos peatonales o paso de vehículos en garajes y rampas de acceso. Su ejecución es similar a la de un pavimento porcelánico, manteniendo especial atención a las juntas recomendadas en zonas exteriores.

ON LAWNS, SAND OR GRAVEL

These dry-installation systems are very common in outdoor areas. The main benefit is the swift installation method with no need for any kind of chemical adhesive. This makes it both simple and economical.

Whether the tiles are to be laid on grass, gravel or sand, they must be supported by an approximately 6cm-thick bed of gravel with a 4 to 8mm particle size.

SOBRE CÉSPED, ARENA o GRAVA

Estos sistemas de colocación en seco son muy comunes en las zonas de exterior. Su mayor ventaja es su colocación rápida y sin ningún tipo de adhesivo químico, por lo que resulta un sistema económico y fácil de acometer.

Tanto si queremos realizar una instalación sobre césped, como si lo hacemos sobre gravilla o arena, deberemos tener en cuenta que la pieza deberá descansar sobre un lecho de unos 6 cm. de espesor de una gravilla de granulometría 4-8 mm.

9&20MM THICKNESS

STANDARD STEP TILES

Standard Step Tiles Specifications Especificaciones De Peldaños Estándar

COLOR BODY PORCELAIN / PORCELÁNICO MASA COLOREADA
RECTIFIED / REINFORCEMENT SIDES / RECTIFICADO / REFUERZO DE CANTOS

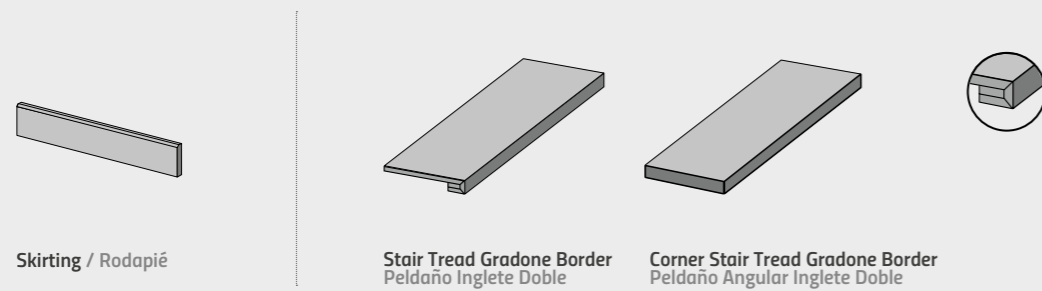

Skirting / Rodapié

Stair Tread Gradone Border
Peldaño Inglete Doble

Corner Stair Tread Gradone Border
Peldaño Angular Inglete Doble

Other Special Pieces Otras Piezas Especiales

Our solutions include customized steps from our mass colored porcelain lines. It is a product capable of adjusting to any type of stairs: catalan stair, floating stairs, turning floating stairs. The measurements and data are recorded in a simple form, collecting the necessary information for cutting the steps.

Nuestras soluciones incluyen peldaños a medida de nuestras colecciones de porcelánico de masa coloreada. Un producto a medida capaz de adecuarse a cualquier tipo de escalera: escalera catalana, escalera colgada, de ojo colgada... Los datos y medidas se anotan en un sencillo formulario que recoge toda la información necesaria para el corte de los peldaños.

Tailored Step Tiles Specifications. OTHER FINISHES Especificaciones De Peldaños A Medida. OTROS ACABADOS

COLOR BODY PORCELAIN / PORCELÁNICO MASA COLOREADA
RECTIFIED / REINFORCEMENT SIDES / RECTIFICADO / REFUERZO DE CANTOS

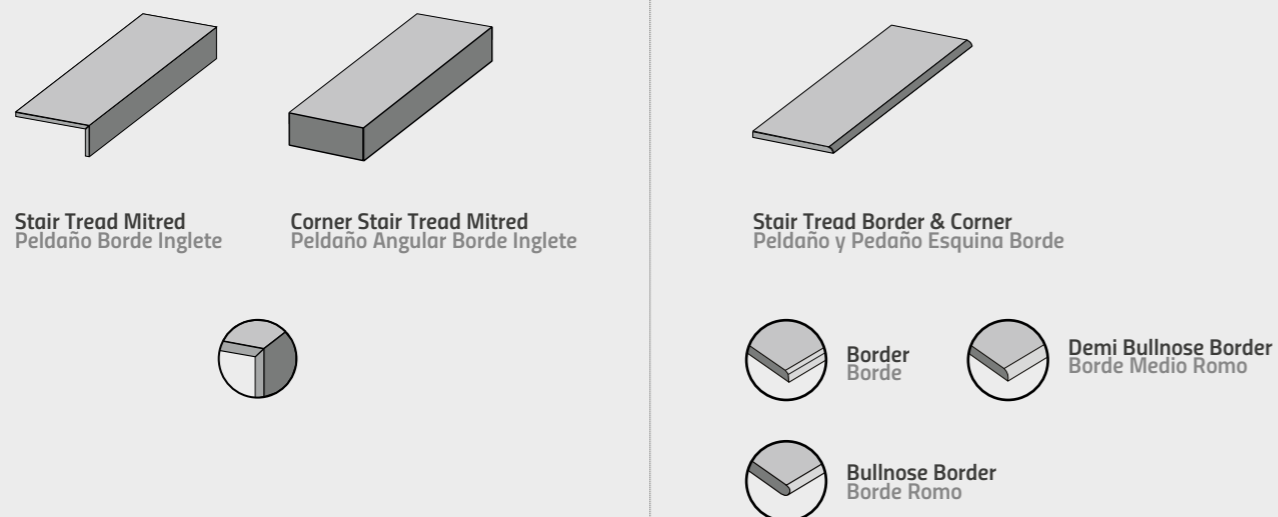

Stair Tread Mitred
Peldaño Borde Inglete

Corner Stair Tread Mitred
Peldaño Angular Borde Inglete

Stair Tread Border & Corner
Peldaño y Pedaño Esquina Borde

Border
Borde

Demi Bullnose Border
Borde Medio Romo

Bullnose Border
Borde Romo

POOL SPECIAL PIECES

20MM Pool Grid Example
Ejemplo Rejillas 20MM



Special Pieces / Pool Grids Piezas Especiales / Rejillas de Piscina

Extra-thick porcelain tiles offer numerous benefits, thanks to their versatility and high resistance. These are properties fully able to meet the tough technical demands and aesthetic requirements of outdoor spaces, public areas, and places subject to high loads or stresses. The tiles can be used in false floor systems, creating raised access flooring that provides easy access to plumbing and electricity networks. They are swift and easy to lay, and the perfect choice for outdoor areas.

El gres porcelánico espesorado ofrece múltiples ventajas gracias a su elevada resistencia y versatilidad. Características que responden a las más altas exigencias a nivel técnico y estético que requieren zonas de exterior, áreas públicas y zonas sometidas a altas cargas y tensiones. Permite su ejecución en sistemas registrables, ofreciendo suelos técnicos elevados fácilmente accesibles a instalaciones de fontanería y electricidad. Rápido y fácil en su ejecución, se trata de un material perfecto para el pavimentado de exteriores.

20MM Standard Pieces for Pools Piezas Estándar para Piscinas en 20MM

COLOR BODY PORCELAIN / PORCELÁNICO MASA COLOREADA
RECTIFIED / REINFORCEMENT SIDES / RECTIFICADO / REFUERZO DE CANTOS



Stair Tread Gradone Border
Peldaño Inglete Doble
298x898x50 mm.
298x1198x50 mm.

Corner Stair Tread Gradone Border
Peldaño Angular Inglete Doble
898x898x50 mm.
1198x1198x50 mm.

Inside Corner Pool Gradone Border
Esquina Int. Piscina Inglete Doble
898x898x50 mm.
1198x1198x50 mm.

Tailored Step Tiles Specifications. OTHER POOL FINISHES Especificaciones De Peldaños A Medida. OTROS ACABADOS PARA PISCINAS

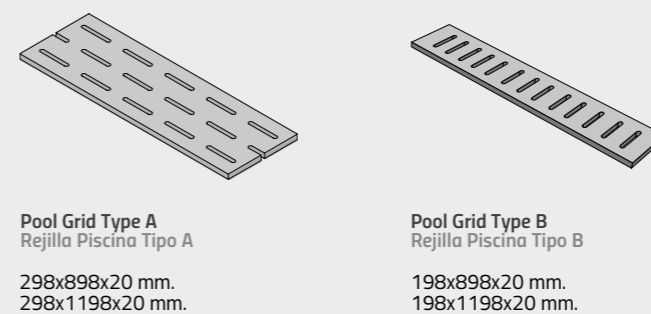

Pool Grid Type A
Rejilla Piscina Tipo A
298x898x20 mm.
298x1198x20 mm.

Pool Grid Type B
Rejilla Piscina Tipo B
198x898x20 mm.
198x1198x20 mm.

Porcelain Tiles Available Sizes & Finishes

Formatos y Acabados Disponibles en Porcelánico

Nominal Size Formato Nominal	Real Size Formato Real	Nat/SBH Finish Acabado Natural Abujardado Suave	Anti-Slip Antideslizante	P.C.	Pz/Box	ML/Box	Kg/Box	Box/Pa	M2/Pa	Kg/Pa
Skirting / Rodapié 5x60 cm.	4,8x59,8x0,9 cm.	●		561	5	2,99	3,00	120	-	-
Skirting / Rodapié 5x90 cm.	4,8x89,8x0,9 cm.	●		591	5	4,49	5,50	70	-	-
Skirting / Rodapié 5x120 cm.	4,8x119,8x0,9 cm.	●		521	5	5,99	7,00	70	-	-
Stair Tread Gradone Border 33,3x60 cm. Peldaño Inglete Doble 33,3x60 cm.	33,3x59,8	●	●	360	2	1,20	-	-	-	-
Stair Tread Gradone Border 33,3x90 cm. Peldaño Inglete Doble 33,3x90 cm.	33,3x89,8	●	●	390	2	1,80	-	-	-	-
Stair Tread Gradone Border 33,3x120 cm. Peldaño Inglete Doble 33,3x120 cm.	33,3x119,8	●	●	792	2	2,40	-	-	-	-
Corner Stair Tread Gradone Border 33,3x60 cm. Peldaño Angular Inglete Doble 33,3x60 cm.	33,3x59,8	●	●	361	1	0,60	-	-	-	-
Corner Stair Tread Gradone Border 33,3x90 cm. Peldaño Angular Inglete Doble 33,3x90 cm.	33,3x89,8	●	●	391	1	0,90	-	-	-	-
Corner Stair Tread Gradone Border 33,3x120 cm. Peldaño Angular Inglete Doble 33,3x120 cm.	33,3x119,8	●	●	822	1	1,20	-	-	-	-

20MM Step Tile & Countertops Availables. Check for Packaging.
Peldaños y Encimeras disponibles en 20MM. Consulte el Embalaje.

Step Tiles Example
Ejemplo De Peldaños



Order Special Pieces On The Web
Hoja De Piezas Especiales En La Web



Livingceramics ORDER FORM PLAN 11.22: SPECIAL PIECES
HOJA DE PEDIDO ENCIMERAS ORDER FORM PLAN COUNTERTOPS

CÓDIGO: CLIENTE: FECHA:

1. MODEL / COLOUR: FINISH: Select finish / Selec. acabado...

2. INDICATE TONE: INDIFFERENT

3. THICKNESS: 6 mm 9 mm 20 mm 4. NUMBER OF UNITS:

5. TYPE OF PIECE:

STAR TREAD BORDER PSELLADO BORDO STAR TREAD SEMI-BELLINO BORDER PSELLADO BORDO MEDIO BORDO STAR TREAD BELLINO BORDER PSELLADO BORDO BORDO

STAR TREAD GRADONE BORDER PSELLADO INGLETE DOBLE BORDO CORNER POOL GRADONE BORDER ESQUINA INT. PISCINA INGLETE DOBLE OUTSIDE CORNER POOL GRADONE BORDER ESQUINA EXT. PISCINA INGLETE DOBLE

STAR TREAD MIMED PSELLADO BORDO INGLETE POOL GRID TYPE A REJILLA PISCINA TIPO A POOL GRID TYPE B REJILLA PISCINA TIPO B

INCLUDE CRISP EDGE INCLUIR "SOTERON" INCLUDE EXTRA GRIP INCLUIR EXTRA AGARRAR NUMBER OF GROOVES / NUMERO DE TRINCHOS 3 4 5

6. DIMENSIONS: A= CM B= CM Th= CM 7. EDGES TREATMENT: FRONT: FRONTAL RIGHT: DERECHO LEFT: IZQUIERDO BACK: POSTERIOR

OBSERVATIONS:

T: +34 964 914 181 / F: +34 964 914 250 WWW.LIVINGCERAMICS.COM - COMERCIAL@LIVINGCERAMICS.COM

BATHROOM FURNITURE SERIES

Special Pieces / Tailored Countertops
Piezas Especiales / Encimeras A Medida

The versatility of our mass colored porcelain pieces allows us to manufacture countertops for bathrooms increasing the decorative options of our lines. The format is customized according to the needs of each client. The measurements and data are recorded in a simple collecting the necessary information for the production of the countertop.

La versatilidad de nuestras piezas porcelánicas de masa coloreada, permite elaborar encimeras para baños aumentando las opciones decorativas de las colecciones. El formato se personaliza en función de las necesidades de cada cliente. Los datos y medidas se anotan en un sencillo formulario que recoge toda la información necesaria para la producción de la encimera.

Countertop Specifications
Especificaciones De Encimeras

COLOR BODY PORCELAIN / PORCELÁNICO MASA COLOREADA
RECTIFIED / REINFORCEMENT FIBERGLASS POLYESTER RESIN
RECTIFICADO / REFUERZO DE FIBRA DE VIDRIO CON RESINA POLIÉSTER

Basins
Lavabos



BATHROOM COUNTERTOPS
ENCIMERAS DE BAÑO

Order Plan Sheet On The Web
Hoja De Pedido En La Web

Livingceramics HOJA DE PEDIDO ENCIMERAS ORDER FORM PLAN COUNTERTOPS

CÓDIGO: CLIENTE: FECHA:

1. MODELO / COLOR: ESPESOR: THICKNESS:

2. Nº DE UNIDADES: NUMBER OF UNITS:

3. DISEÑO DE ENCIMERA: RELENAR LOS SIGUIENTES CAMPOS Y MARCAR LAS CASILLAS CORRESPONDIENTES. COUNTERTOP DESIGN: FILL THE FOLLOWING FIELDS AND MARK THE RESPECTIVE BOXES.

3.1. DIMENSIONES: A= CM B= CM h= CM 3.2. LATERALES A TRATAR: 1= 2= 3=

3.3. AGUJEROS DE DESAGUE: C1= CM C2= CM D1= CM D2= CM 3.4. AGUJEROS GRIFFERIA: E1= CM E2= CM F1= CM F2= CM

4. ESTRUCTURA DE APOYO: SI No 5. MATERIAL EN STOCK: SI No

OBSERVACIONES: ANOTAR EN OBSERVACIONES LOS PEDIDOS ESPECIALES. THE SPECIAL ORDERS SHOULD BE RECORDED BELOW.

T: +34 964 914 181 / F: +34 964 914 250 WWW.LIVINGCERAMICS.COM - COMERCIAL@LIVINGCERAMICS.COM

FURNITURE SERIES & BASINS
MUEBLES DE BAÑO Y LAVABOS

Order Plan Sheet On The Web
Hoja De Pedido En La Web



Livingceramics HOJA DE PEDIDO BAÑO ORDER FORM PLAN BATHROOM

CÓDIGO: CLIENTE: FECHA:

RELENAR LOS SIGUIENTES CAMPOS Y MARCAR LAS CASILLAS CORRESPONDIENTES. FILL THE FOLLOWING FIELDS AND MARK THE RESPECTIVE BOXES.

8. BASINS & FURNITURE / LAVABOS Y MUEBLES

LAVABOS CERÁMICOS CERAMIC BASINS MUEBLES DE MADERA WOODEN FURNITURE

DIMENSION 47 CM: A= 47 (47 cm) B= 58 (58 cm) C= 63 (63 cm) D= 63 (63 cm) E= 63 (63 cm) F= 63 (63 cm)

DIMENSION 50 CM: A= 50 (50 cm) B= 58 (58 cm) C= 63 (63 cm) D= 63 (63 cm) E= 63 (63 cm) F= 63 (63 cm)

DIMENSION 52 CM: A= 52 (52 cm) B= 58 (58 cm) C= 63 (63 cm) D= 63 (63 cm) E= 63 (63 cm) F= 63 (63 cm)

DIMENSION 58 CM: A= 58 (58 cm) B= 58 (58 cm) C= 63 (63 cm) D= 63 (63 cm) E= 63 (63 cm) F= 63 (63 cm)

DIMENSION 60 CM: A= 60 (60 cm) B= 58 (58 cm) C= 63 (63 cm) D= 63 (63 cm) E= 63 (63 cm) F= 63 (63 cm)

DIMENSION 62 CM: A= 62 (62 cm) B= 58 (58 cm) C= 63 (63 cm) D= 63 (63 cm) E= 63 (63 cm) F= 63 (63 cm)

DIMENSION 64 CM: A= 64 (64 cm) B= 58 (58 cm) C= 63 (63 cm) D= 63 (63 cm) E= 63 (63 cm) F= 63 (63 cm)

DIMENSION 66 CM: A= 66 (66 cm) B= 58 (58 cm) C= 63 (63 cm) D= 63 (63 cm) E= 63 (63 cm) F= 63 (63 cm)

DIMENSION 68 CM: A= 68 (68 cm) B= 58 (58 cm) C= 63 (63 cm) D= 63 (63 cm) E= 63 (63 cm) F= 63 (63 cm)

DIMENSION 70 CM: A= 70 (70 cm) B= 58 (58 cm) C= 63 (63 cm) D= 63 (63 cm) E= 63 (63 cm) F= 63 (63 cm)

DIMENSION 72 CM: A= 72 (72 cm) B= 58 (58 cm) C= 63 (63 cm) D= 63 (63 cm) E= 63 (63 cm) F= 63 (63 cm)

DIMENSION 74 CM: A= 74 (74 cm) B= 58 (58 cm) C= 63 (63 cm) D= 63 (63 cm) E= 63 (63 cm) F= 63 (63 cm)

DIMENSION 76 CM: A= 76 (76 cm) B= 58 (58 cm) C= 63 (63 cm) D= 63 (63 cm) E= 63 (63 cm) F= 63 (63 cm)

DIMENSION 78 CM: A= 78 (78 cm) B= 58 (58 cm) C= 63 (63 cm) D= 63 (63 cm) E= 63 (63 cm) F= 63 (63 cm)

DIMENSION 80 CM: A= 80 (80 cm) B= 58 (58 cm) C= 63 (63 cm) D= 63 (63 cm) E= 63 (63 cm) F= 63 (63 cm)

FINISHED / ACABADO: ACABADO CERÁMICA CERAMIC FINISH

COLOR: COLOR: COLOR MADERA WOOD COLOR: NATURAL OAK DARK OAK DRY OAK

TEXTURA MADERA WOOD TEXTURE: SHADOW FINISH STROKES STRIPED

OBSERVATIONS / OBSERVACIONES:

T: +34 964 914 181 / F: +34 964 914 250 WWW.LIVINGCERAMICS.COM - COMERCIAL@LIVINGCERAMICS.COM

Recommendations / Recomendaciones

Livingceramics recommends consulting the norms that regulate the placement of ceramic tiles. It is essential, before any installation, to carefully read the **UNE 138002 and UNE 12004** standard, and to attend to the specified in order to achieve a correct placement of the ceramic tile. We indicate below, a summary of the most important points to take into account:

Livingceramics recomienda consultar la normativa que regula la colocación de baldosas cerámicas. Es indispensable, antes de cualquier instalación, leer con detenimiento la norma **UNE 138002 y UNE 12004**, y atender a lo especificado con el fin de conseguir una correcta colocación de la baldosa cerámica. Señalamos a continuación, un resumen de los puntos más importantes a tener en cuenta:

Installation Recommendations / Recomendaciones De Instalación

- 1 CONFORMITY OF TONE AND CALIBER OF THE MATERIAL.
VERIFICAR EL DESTONIFICADO DEL MATERIAL.
- 2 MAKE SURE THAT THE AREA TO CLAD IS CLEAN AND DRY.
ASEGURAR QUE LA ZONA A REVESTIR ESTÁ LIMPIA Y SECA.
- 3 CEMENT-BASED ADHESIVE SHOULD BE USED FOR EACH TYPE OF PRODUCT; PORCELAIN COLOR BODY OR WHITE BODY.
UTILIZAR EL ADHESIVO DE CLASE CEMENTO COLA SEGÚN TIPOLOGÍA DE PRODUCTO; PORCELÁNICO MASA COLOREADA O PASTA BLANCA.
- 4 THE AREA TO CLAD MUST BE UNIFORMLY LEVELED. THE USE OF LEVELING SYSTEMS IS MANDATORY FOR A PERFECT INSTALLATION.
EL USO DE SISTEMAS DE NIVELACIÓN ES OBLIGATORIO PARA UNA PERFECTA COLOCACIÓN. LA ZONA A REVESTIR DEBE ESTAR PERFECTAMENTE NIVELADA.
- 5 A 2 MM MINIMUM JOINT IS RECOMMENDED TO PLACE THE PIECES CORRECTLY.
SE RECOMIENDA UNA JUNTA MÍNIMA DE 2 MM PARA LA COLOCACIÓN ENTRE PIEZAS.
- 6 THE RECTANGULAR FORMATS CANNOT BE PLACED UNITED TO ANY MORE THAN 1/4 OF THE PIECE.
LOS FORMATOS RECTANGULARES NO SE PUEDEN COLOCAR TRABADOS A MÁS DE 1/4 DE LA PIEZA.

THE SLAB INSTALLATION REQUIRES THE USE OF TOOLS AND SPECIFIC TRAINING BY THE INSTALLER. IN ADDITION TO THE ABOVE, THESE ARE SOME OF THE RECOMMENDATIONS TO TAKE INTO ACCOUNT IN THE INSTALLATION OF LARGE TILE FORMATS:

LA INSTALACIÓN DE GRANDES FORMATOS REQUIERE DE HERRAMIENTAS Y UNA FORMACIÓN ESPECÍFICA POR PARTE DEL COLOCADOR. A DEMÁS DE LAS ANTERIORES, ESTAS SON ALGUNAS DE LAS RECOMENDACIONES A TENER EN CUENTA EN LA INSTALACIÓN DE GRANDES FORMATOS CERÁMICOS:



CUTTING DETAIL WITH GUIDE ON SLAB
DETALLE DE CORTE CON GUÍA SOBRE PLANCHA

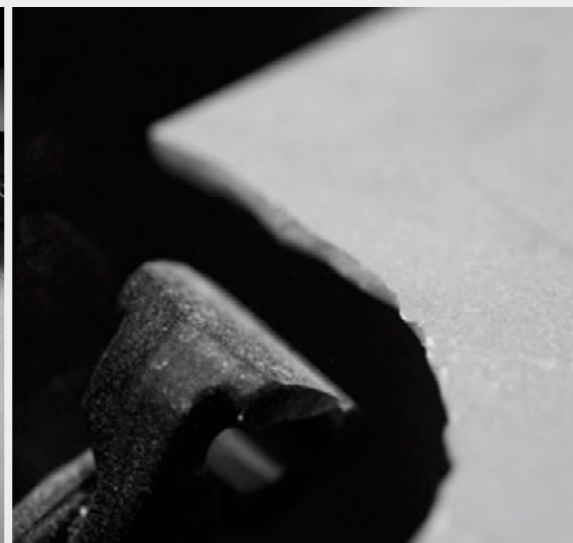

THE TILES' DUCTILE PROPERTIES MAKE THEM EASY TO CUT
LAS PROPIEDADES ESPECIALES DE DUCTILE LO HACEN MÁS FÁCIL DE CORTAR

- 7 THE DOUBLE BONDING TECHNIQUE MUST ALWAYS BE USED.
SE HA DE EMPLEAR SIEMPRE LA TÉCNICA DEL DOBLE ENCOLADO.

**THE DOUBLE BONDING TECHNIQUE MUST ALWAYS BE USED.
SE HA DE EMPLEAR SIEMPRE LA TÉCNICA DEL DOBLE ENCOLADO.**

- 8 THIS MATERIAL REQUIRES THE USE OF C2 CLASS ADHESIVES (BICOMPONENT TYPE S2).
ES RECOMENDABLE EL USO DE ADHESIVOS CLASE C2 ALTAMENTE FLEXIBLES (BICOMPONENTES TIPO S2).

- 9 THE APPEARANCE OF AIR POCKETS BETWEEN TILE AND SUBSTRATE SHOULD BE AVOIDED BY THE SYSTEMATIC KNOCKING OF THE TILE WITH A RUBBER TROWEL. THIS WILL AVOID TENSIONS AND BREAKS AFTER THE MATERIAL HAS BEEN SET.
SE DEBERÁ EVITAR LA APARICIÓN DE BOLSAS DE AIRE ENTRE BALDOSA Y SUSTRATO MEDIANTE EL GOLPEADO SISTEMÁTICO DE LA CERÁMICA CON UNA LLANA DE GOMA. ESTO EVITARÁ TENSIONES Y ROTURAS TRAS EL FRAGUADO DEL MATERIAL.

- 10 THE USE OF SPECIFIC TOOLS FOR INSTALLING CERAMIC TILES IS MANDATORY. CONSULT YOUR TRUSTED SUPPLIER TO RECEIVE INSTRUCTIONS ON THE CORRECT HANDLING OF THESE TOOLS AND THEIR NEEDS.
ES INDISPENSABLE UTILIZAR HERRAMIENTAS ESPECÍFICAS PARA EL ALICATADO DEL GRAN FORMATO CERÁMICO. CONSULTE CON SU PROVEEDOR DE CONFIANZA PARA RECIBIR INTRUCCIONES DEL CORRECTO MANEJO DE ESTAS HERRAMIENTAS Y SUS NECESIDADES.

Play Video / Reproducir Video



BIG SLAB INSTALLATION
INSTALACIÓN DEL GRAN FORMATO

Cleaning & Maintenance / Limpieza & Mantenimiento

Once placed and grout cleaning equipment is mandatory. Improper cleaning may leave traces of products used in the placement or the protection of the tiles, as cements, resins epoxilicas, grout, waxes or fats. For optimal cleaning after placement for cases of intense and stubborn dirt accumulated over time, and for maintenance, required to use the right products. The following table shows some of the recommendations.

Una vez colocado y rejuntado el material es obligatoria la limpieza. Una limpieza incorrecta puede dejar restos de productos empleados en la colocación o de la protección de las baldosas, como cementos, resinas epoxilicas, material de rejuntado, ceras o grasas. Para una optima limpieza tras la colocación, para casos de suciedad intensa e incrustada acumulada en el tiempo, y para su mantenimiento, se precisa emplear los productos adecuados. En la tabla siguiente mostramos algunas de las recomendaciones.

FILACLEANER	MAINTENANCE IN GENERAL. MANTENIMIENTO EN GENERAL.
FILACR10	WASTE EPOXY, VITRIFIED OR RESIN BOARD. RESIDUOS DE JUNTA EPOXI, JUNTA VITRIFICADA O JUNTA RESINOSA.
DETERDEK	WASTE CONCRETE PLACEMENT, LIMESCALE, METALS STRIPES, OXIDE DEPOSITS. RESIDUOS DE CEMENTO DE COLOCACIÓN, RESIDUOS CALCÁREOS, RAYAS METALES, DEPOSITOS DE ÓXIDO.
FILASOLV	CANDLE WAX, TREE RESINS, TAPE RESIDUE, TAR RESIDUE. CERA DE VELAS, RESINA DE ÁRBOL, RESIDUOS DE CINTA ADHESIVA, RESIDUOS ALQUITRÁN.
FILANOPAINT STAR	PAINTED GRAFFITI, SPRAY ACRYLIC, ALKYD AND SYNTHETIC NITROS. PINTADAS DE GRAFITIS, SPRAY ACRÍLICOS, ALQUÍDICOS Y NITROS SINTÉTICOS.
FILAPS87	DRINKS, FOOD, FATS, OILS, RUBBER, DYES, MARKER, ACRYLIC PAINT DROPS. BEBIDAS, COMIDAS, GRASAS, ACEITES, GOMA, TINTES, ROTULADOR, GOTAS DE PINTURA PLÁSTICA.

THE FOLLOWING GENERAL TERMS AND CONDITIONS GOVERN SALES BETWEEN LVG Ceramic Surfaces. S.L. AND ITS CLIENTS.**1. Orders**

The parties' obligations concerning deliveries of goods (the transfer of responsibilities, expenses, insurance, customs procedures etc.) shall be those deriving from the agreed specific terms and conditions (INCOTERMS 2020). Barring possible agreed written amendments or exceptions, the general terms and conditions outlined herein shall regulate all sale agreements between our company and the buyer and hence both the contractual agreement that was reached on acceptance of this order and any future agreement for the supply of products by our company through successive different orders. Variations in the general sales conditions and in any sales offers, transactions, credit notes or discounts agreed upon by our Agents or by other intermediaries shall only be deemed to be valid once they have been accepted in writing by our head office and, in all such cases, this written acceptance shall only apply to the related agreement.

2. Supplies and deliveries of goods

On reception of a delivery of goods, the buyer shall immediately inspect them for flaws or defects. LVG Ceramic Surfaces. S.L. must be given written notice of any external or visible flaws within

fifteen (15) days of the reception of the goods. In the case of hidden flaws, the deadline for claims shall be thirty (30) days from the reception of the goods. If no notice of any flaws is given by the buyer within the said deadlines, the latter shall be deemed to have approved the goods. The buyer of a faulty product must make a claim within the aforementioned stipulated period, opting for one of the following possible solutions:

1. The delivery of a new product in exchange for the return of the faulty one.
2. A refund of the price that was paid in exchange for the return of the faulty product.

The distributor shall be liable for attaching the warranty, technical specifications and product care instructions to the invoice given to the client.

3. Returns

Faulty goods must be returned in the same state and packaging in which they were received. Orders received directly from clients or placed on the latter's behalf by our representatives shall always be subject to our acceptance. The acceptance of a return by LVG Ceramic Surfaces. S.L. does not mean that it admits or agrees to the claim for the faulty product. In the event of mistakes in the number of goods that are supplied, the buyer shall only be entitled to claim for the number that was not delivered.

LAS SIGUIENTES CONDICIONES GENERALES RIGEN LAS COMPRAVENTAS ENTRE LVG Ceramic Surfaces. S.L. Y EL CLIENTE.**1. Normativa para la contratación**

Las obligaciones de las partes en relación a la entrega de la mercancía (traspaso de responsabilidad, gastos, seguros, trámites aduaneros, etc.) serán las resultantes de las condiciones particulares pactadas (INCOTERMS 2020). Las condiciones generales aquí detalladas, salvo posibles modificaciones o excepciones acordadas por escrito, regulan todos los contratos de venta celebrados entre nuestra empresa y el comprador, y por consiguiente, tanto el contrato concluido al aceptar el presente pedido, como cualquier futuro contrato de suministro de los productos de nuestra empresa que se solicitarán con sucesivos y distintos pedidos. Las variaciones de las condiciones generales de venta, las ofertas, las transacciones, los abonos o los descuentos, acordados por nuestros Agentes u otros intermediarios, no se consideran válidos si nuestra sede no los ha aceptado por escrito, limitándose, en cualquier caso, a los contratos a los que se refieren.

2. Suministro y entrega

Tras la recepción de la mercancía, el comprador está obligado a examinarla inmediatamente en cuanto a sus defectos o vicios. Los defectos externos o visibles deberán notificarse por escrito a LVG Ceramic Surfaces. S.L. en el plazo de quince (15) días desde la recepción de la mercancía. Tratándose de vicios ocultos el plazo de reclamación será de treinta (30) días desde su recepción. Si

el comprador no realiza notificación alguna de defectos en dichos plazos, la mercancía se considerará conforme. La parte compradora de una mercancía que se encuentre en estado defectuoso, como se ha indicado, debe reclamar en plazo y optar a las siguientes vías de solución:

1. La entrega de una mercancía nueva a cambio de la devolución de la defectuosa.
2. Reintegro del precio abonado a cambio de la de la devolución de la defectuosa.

Por otra parte, el distribuidor se responsabiliza de adjuntar en la factura que debe dar al cliente tanto la Garantía, como las especificaciones técnicas y mantenimiento.

3. Devolución

La mercancía defectuosa debe devolverse en el estado y con en el embalaje mediante el cual ha sido entregada. Los pedidos recibidos directamente de los clientes o realizados por nuestros representantes en nombre de ellos siempre estarán sujetos a nuestra aceptación. Se tiene en cuenta que la realización de una devolución aceptada por LVG Ceramic Surfaces. S.L. no significa que se asuma o reconozca la reclamación debida a defectos en la mercancía. En caso de defectos en la cantidad suministrada, el comprador tendrá únicamente derecho a poder reclamar la cantidad no entregada.

4. Deliveries

Goods delivered by LVG Ceramic Surfaces. S.L. are subject to retention of title. The ownership of the goods shall only be transferred to the buyer when they have been fully paid for. LVG Ceramic Surfaces. S.L. shall be entitled to offset any sum owed to it by the buyer against any sum payable by the company to the buyer. In the event of failure to comply with the conditions regarding the payment and/or return of the agreed goods, the buyer shall be liable for the cost of their return, plus any expenses of an administrative nature or costs derived from legal claims, including the fees of solicitors and court representatives. In the event of a delay in the payment of goods by the buyer, the seizure of the latter's goods or a substantial decline in the buyer's financial situation, LVG Ceramic Surfaces. S.L. shall be entitled to claim immediate payment of the invoiced amount, to withhold all pending supplies and services, to condition the delivery of goods—once the buyer is no longer in arrears—upon their advance payment and, if applicable, to claim for any corresponding compensation. Under no circumstances may the goods be resold through a website (online sales). Unless agreed otherwise, the buyer shall be forbidden from exporting materials supplied by LVG Ceramic Surfaces. S.L. and from making them available to companies or individuals who go on to export them.

4. Entrega

Las mercancías entregadas por LVG Ceramic Surfaces. S.L. están sujetas a reserva de dominio. La propiedad de la mercancía únicamente pasará al comprador en el momento en que esté completamente pagada. LVG Ceramic Surfaces. S.L. tiene derecho a compensar cualquier suma que le adeude el comprador contra cualquier suma que resulte pagadera al comprador. En caso de incumplimiento de las condiciones de pago y/o devolución de los efectos negociados, serán de cuenta del comprador los gastos de devolución más los gastos de administración y reclamación judicial que se originen en su caso, incluidos los honorarios de letrados y procuradores. En caso de mora en el pago de la mercancía por el comprador, así como si sufriera embargo en sus bienes o si se produjera un empeoramiento sustancial de su situación patrimonial, LVG Ceramic Surfaces. S.L. estará facultada para reclamar el pago inmediato del importe facturado y retener todos los suministros y prestaciones pendientes y condicionar la entrega de las mercaderías - aun cuando el comprador ya no se encuentre en mora - al pago por adelantado de las mismas así como, en su caso, a reclamar la indemnización correspondiente. En ningún caso la mercancía podrá ser objeto de reventa mediante el uso de una página web (venta online). Siempre que no existan acuerdos contrarios, se prohíbe al Comprador exportar los materiales que le suministre nuestra empresa, o cedérsela a empresas o personas que los exporten.

5. Competent jurisdiction

The resulting relations between the parties shall be subject to the legislation of the Kingdom of Spain. Both parties expressly waive their right to any other corresponding jurisdiction and they agree to abide by the decisions of the Vila-real Law Courts (Castellón) in the settlement of any dispute, controversy or claim that might arise in connection with the said commercial relations.

6. Data protection

In accordance with Spanish Data Protection Act 15/1999 of December 13th, the personal data supplied by the buyer shall be entered in LVG Ceramic Surfaces. S.L.'s client file for the purpose of managing contractual relations and controlling and managing sales and the corresponding collection of payment. LVG Ceramic Surfaces. S.L. shall process the said data with all due confidentiality and it undertakes not to use the said information for any other purpose than that cited above. Likewise, it agrees to take the necessary steps to keep the data safe and to avoid its alteration, loss, and unauthorized access or processing. The buyer shall be entitled to exercise its right of access, rectification, cancellation and objection by giving written notice to LVG Ceramic Surfaces. S.L..

5. Tribunal competente

Las partes someten las relaciones resultantes entre las mismas a lo dispuesto en la Legislación del Reino de España y, con renuncia expresa al propio fuero que pudiera corresponderles, se someten a los juzgados y tribunales de Vila-real (Castellón) para resolver cualquier controversia, conflicto o reclamación que surja en conexión con la relación comercial establecida entre las mismas.

6. Protección de Datos de Carácter Personal

Conforme a la Ley Orgánica de 15/1999 de 13 de diciembre de Protección de Datos de Carácter Personal, los datos de carácter personal facilitados por el comprador formarán parte del fichero de clientes de LVG Ceramic Surfaces. S.L., cuyos fines son el mantenimiento de la relación contractual, el control y gestión de las ventas y sus correspondientes cobros. LVG Ceramic Surfaces. S.L. tratará dichos datos con la máxima confidencialidad, y se compromete a no utilizarlos con un fin distinto a aquel para el que han sido recabados, así como a conservarlos con las debidas medidas que garanticen su seguridad y eviten su alteración, pérdida, tratamiento o acceso no autorizados. El comprador tiene la posibilidad de ejercitar los derechos de acceso, rectificación, cancelación y oposición dirigiendo una comunicación por escrito a LVG Ceramic Surfaces. S.L..

CONTEMPORARY MIXTURES SURFACES & SIGNATURE SURFACES

2024 EDITION I / 2024 EDICIÓN I



Livingceramics

Headquarters, Showroom and Warehouse
Oficinas, Showroom Y Almacén
Ctra. Vila-real – Onda CV 20 KM 2.5
12540, Vila-real, Castellón, Spain

Production Center
Centro De Producción
Ctra. Onda – Ribesalbes CV 191 KM 3
12200, Onda, Castellón, Spain

Tel. +34 964 914 181
www.livingceramics.com
info@livingceramics.com

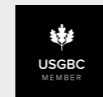

Legal Information
Información Legal

LVG Ceramic Surfaces. S.L. reserves the right to make changes and modifications deemed necessary. Because of the printing process, the colors shown in this catalog are approximate, not exact. The information in this catalog is fully protected by copyright. Total or partial reproduction of text, illustrations, images and graphical representations is forbidden without the express permission of Livingceramics.

LVG Ceramic Surfaces. S.L. se reserva el derecho de hacer variaciones y modificaciones que considere oportunas. A causa de los procesos de impresión, los colores que aparecen en este catálogo deben considerarse aproximados, no exactos. La información de este catálogo está protegida en su totalidad por copyright. Está prohibida la reproducción total o parcial de los textos, ilustraciones, imágenes y representaciones gráficas sin la autorización expresa de Livingceramics.



SME INNOVATIVE / PYME INNOVADORA

The Spanish Ministry for Science, Innovation & Universities rewards Livingceramics efforts in the fields of R&D and innovation. This mention is the outcome of the incorporation of state-of-the-art technology to our production plant in order to produce large-format tiles conspicuous for their unique finishes.

El Ministerio de Ciencia, Innovación y Universidades reconoce a Livingceramics la inversión en investigación y Desarrollo de productos diferenciadores en la industria cerámica actual. Se trata de un reconocimiento estatal que verifica la inversión realizada por la empresa en su proceso de producción y búsqueda continua. Galardona así la innovación y el esfuerzo realizado por Livingceramics a la hora de invertir en I+D+i.



Livingceramics