

03

antoniolupi

lo stato
delle idee /
the state of
ideas

antoniolupi

MADE IN ITALY

STRATO E DOMINO

attrezzatura cassette
drawers equipment

STRATO

2015

design_AL Studio

La cura dei dettagli, la coerenza estetica e progettuale, il senso del bello sotto ogni aspetto, anche in quello che può apparire secondario o poco visibile. antoniolupi esprime la propria attitudine a un total look sofisticato ed elegante anche all'interno di mobili, cassetti e contenitori. Uno spazio importante, fondamentale, per il quale è necessaria un'organizzazione funzionale, ma anche un territorio spesso sconosciuto, da esplorare e mostrare senza timore. Il sistema di attrezzature per cassetti Strato è l'essenza dell'eleganza che si esprime in un accessorio indispensabile non solo per il corretto svolgimento di semplici azioni quotidiane ma anche per definire l'immagine complessiva dell'arredo. Divisori eleganti e resistenti, realizzati in cristallo fumè e disponibili in diverse dimensioni, per cassetti Slim. Partizioni che permettono di razionalizzare lo spazio ma anche di conferire identità e stile all'interno dei cassetti. "Dio è nel dettaglio" diceva Mies van der Rohe. Per antoniolupi lo è anche in ciò che non sempre si vede.

The attention to detail, consistency and aesthetic design, the sense of beauty in every respect, even in what may seem secondary or inconspicuous. antoniolupi expresses its own attitude with a total sophisticated and elegant look also inside the furniture, drawers and containers. An important area, vital, for which you need functional organization, an unexplored territory to show without fear.

The internal drawer accessories Strato are the essence of elegance that is expressed in an essential accessory not only for the proper performance of simple daily actions but also to define the overall image of the cabinet. Elegant and resistant dividers made of smoked glass and available in different sizes, for Slim drawers. Partitions that allow you to rationalize space but also to confer identity and style inside the drawers.

"God is in the details" Mies van der Rohe would say. For antoniolupi it's important also in things that aren't visible.









L 27

Attrezzatura con 2 divisori in vetro fumé.
Internal drawer accessory with 2 dividers in fumé glass.



Cassetto interno
Internal drawer

Cassetto esterno
Drawer

P	L	ART.	ART.
40/47	27	SRC4027	SRI4027
50/54	27	SRC5427	SRI5427

L 36

Attrezzatura con 2 divisori in vetro fumé.
Internal drawer accessory with 2 dividers in fumé glass.



Cassetto interno
Internal drawer

Cassetto esterno
Drawer

P	L	ART.	ART.
40/47	36	SRC4036	SRI4036
50/54	36	SRC5436	SRI5436

L 45

Attrezzatura con 2 divisori in vetro fumé.
Internal drawer accessory with 2 dividers in fumé glass.



Cassetto interno
Internal drawer

Cassetto esterno
Drawer

P	L	ART.	ART.
40/47	45	SRC4045	SRI4045
50/54	45	SRC5445	SRI5445

L 54

07 Attrezzatura con 2 divisori in vetro fumé.
Internal drawer accessory with 2 dividers in fumé glass.

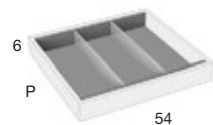

Cassetto interno
Internal drawer

Cassetto esterno
Drawer

P	L	ART.	ART.
40/47	54	SRC4054	SRI4054
50/54	54	SRC5454	SRI5454

L 63

07 Attrezzatura con 4 divisori in vetro fumé.
Internal drawer accessory with 4 dividers in fumé glass.

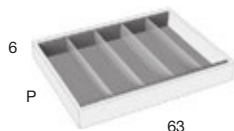

Cassetto interno
Internal drawer

Cassetto esterno
Drawer

P	L	ART.	ART.
40/47	63	SRC4063	SRI4063
50/54	63	SRC5463	SRI5463

07 Nel caso di cassetto sagomato non è possibile inserire l'attrezzatura. Non è possibile realizzare l'attrezzature a misura.
It is not possible to use the internal drawer accessory in shaped drawers. The drawer equipment can't be realized in custom size measurements.

L 72



07 Attrezzatura con 4 divisori in vetro fumé.
Internal drawer accessory with 4 dividers in fumé glass.

		Cassetto interno Internal drawer	Cassetto esterno Drawer
P	L	ART.	ART.
40/47	72	SRC4072	SRI4072
50/54	72	SRC5472	SRI5472

L 90

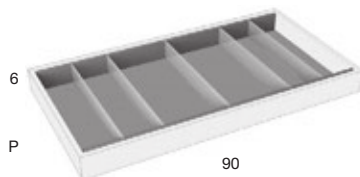

07 Attrezzatura con 5 divisori in vetro fumé.
Internal drawer accessory with 5 dividers in fumé glass.

		Cassetto interno Internal drawer	Cassetto esterno Drawer
P	L	ART.	ART.
40/47	90	SRC4090	SRI4090
50/54	90	SRC5490	SRI5490

L 108

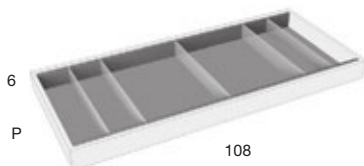

07 Attrezzatura con 5 divisori in vetro fumé.
Internal drawer accessory with 5 dividers in fumé glass.

		Cassetto interno Internal drawer	Cassetto esterno Drawer
P	L	ART.	ART.
40/47	108	SRC40108	SRI40108
50/54	108	SRC54108	SRI54108

L 126

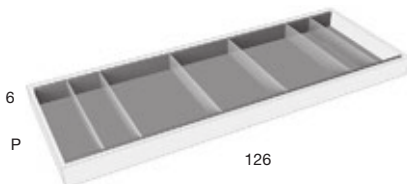

07 Attrezzatura con 6 divisori in vetro fumé.
Internal drawer accessory with 6 dividers in fumé glass.

		Cassetto interno Internal drawer	Cassetto esterno Drawer
P	L	ART.	ART.
40/47	126	SRC40126	SRI40126
50/54	126	SRC54126	SRI54126

Vaschetta porta oggetti per cassetti H 18 cm.
Storage compartment for drawers H 18 cm.

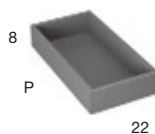

		ART.
P	L	ART.
40/47	22	SRV4022
50/54	22	SRV5422

DOMINO

2017

design_AL Studio

Sempre alla ricerca della qualità assoluta in ogni singolo dettaglio, anche in quelli apparentemente più nascosti, antoniolupi propone un sistema di divisori per cassetti che associa la massima funzionalità, all'eccellenza dei materiali e delle lavorazioni tipiche di ogni prodotto dell'azienda. Chiamati a svolgere un ruolo sempre più importante nella gestione dello spazio interno, questi accessori testimoniano la costante tensione verso la bellezza sotto ogni aspetto. Il progetto prevede due moduli che combinati tra loro, formano più composizioni divisorie ortogonali, così da garantire la massima personalizzazione, in base alle esigenze di contenimento. Anche in questi accessori, la qualità assoluta di una materia ricca di storia e la sofisticata contemporaneità della finitura in noce canaletto, incontrano il linguaggio minimale delle collezioni di mobili e contenitori, per dar vita a un interno ricco di fascino e di eleganza. Interni da mostrare, da svelare, da portare a testimonianza di stile, cultura e passione.

Always looking for the highest quality in every detail even in the most seemingly hidden. Antoniolupi proposes a dividing system for drawers that combines maximum functionality to the excellence of materials and processes typical of each product of the company. Called upon to play an increasingly important role in the management of the internal space, these accessories testify to the constant tension towards beauty in every aspect. The project includes two modules that combined between them form more perpendicular divider compositions, so as to ensure the maximum customization according to each need. Even in these accessories the absolute quality of a material rich in history and the contemporary sophistication of the finish in noce canaletto are suitable for the furniture collections to create an interior full of charm and elegance. Interior to show, to reveal, to demonstrate style, culture and passion.



antoniolupi ha scelto per garantire la qualità e la durata dei suoi divisori per cassetti, un materiale innovativo, l'HPL, un laminato ad alta pressione dello spessore di 5 mm, costituito da numerosi strati di carta impregnati con resine termoindurenti e compattati attraverso l'azione combinata del calore e della pressione. Un prodotto stabile e omogeneo, non poroso e di alta densità, con caratteristiche fisiche e chimiche del tutto diverse dai suoi elementi costitutivi. Questo straordinario materiale è stato poi impiallacciato in noce canaletto con finitura ad olio naturale. Gli accessori sovrapponibili sono invece realizzati in alluminio dello spessore di 2 mm, per poi essere rifiniti con vernici a polveri epossidica.

antoniolupi chose to guarantee quality and durability of its drawer accessories with an innovative material, HPL, a high pressure laminate 5 mm thick, consisting of many layers of paper saturated with thermosetting resins and compacted through the combined action of heat and pressure. A stable and homogeneous, non-porous and high density product, with physical and chemical characteristics quite different from its components. This extraordinary material was then veneered in walnut with a natural oil finish. The overlapping accessories are made of aluminum 2 mm thick, then finished with epoxy powder paints.



art. DOMINO12
H 5 / P 9,9 / L 23
divisorio per cassetti
divider for drawers



art. DOMINO20
H 5 / P 32,3 / L 23
vassoio da appoggio
tray

per cassetti profondità 40/47 cm e 54 cm

for drawers 40/47 and 54 cm deep



art. DOMINO1

H 5 / P 32,3 / L 23
divisorio per cassetti

divider for drawers

per cassetti profondità 54 cm

for drawers 54 cm deep



art. DOMINO2

H 5 / P 42,3 / L 23
divisorio per cassetti

divider for drawers

per cassetti profondità 40/47 cm

for drawers 40/47 cm deep



art. DOMINO10

H 5 / P 32,3 / L 13
divisorio per cassetti

divider for drawers

art. DOMINO13

H 4,5 / P 12 / L 12
vaschetta

storage compartment



art. DOMINO14

H 4,5 / P 12 / L 12
contenitore per rossetti

lipstick storage compartment



per cassetti profondità 54 cm

for drawers 54 cm deep



art. DOMINO11

H 5 / P 42,3 / L 13
divisorio per cassetti

divider for drawers

art. DOMINO13

H 4,5 / P 12 / L 12
vaschetta

storage compartment



art. DOMINO14

H 4,5 / P 12 / L 12
contenitore per rossetti

lipstick storage compartment



art. DOMINO16
H 1,3 / P 22 / L 12
porta oggetti

storage compartment



art. DOMINO30
H 4,5 / P 32,1 / L 12
porta oggetti

storage compartment



art. DOMINO15
H 4,5 / P 12 / L 22
contenitore per kleenex

tissue storage compartment



art. DOMINO16
H 1,3 / P 22 / L 12
porta oggetti

storage compartment



art. DOMINO31
H 4,5 / P 42,1 / L 12
porta oggetti

storage compartment



art. DOMINO15
H 4,5 / P 12 / L 22
contenitore per kleenex

tissue storage compartment



DOMINO1, DOMINO2, DOMINO10, DOMINO11, DOMINO12, DOMINO20
Noce Canaletto_Canaletto walnut

DOMINO13, DOMINO14, DOMINO15, DOMINO16, DOMINO30,
DOMINO31
Alluminio finitura bronzo_Aluminium bronze finish

per cassetti profondità 54 cm
for drawers 54 cm deep



art. DOMINO21
H 12,8 / P 9,9 / L 23
divisorio per cassetti solo per H 18 cm
divider only for drawers H 18 cm

per cassetti profondità 40/47 cm e 54 cm
for drawers 40/47 cm and 54 cm deep



art. DOMINO22
H 12,8 / P 32,3 / L 23
divisorio per cassetti solo per H 18 cm
divider only for drawers H 18 cm

per cassetti profondità 54 cm
for drawers 54 cm deep



art. DOMINO23
H 12,8 / P 42,3 / L 23
divisorio per cassetti solo per H 18 cm
divider only for drawers H 18 cm

DOMINO21, DOMINO22, DOMINO23
Noce Canaletto_Canaletto walnut

compensatore *filler*

Prof. 40/47 cm

art. DOMINOC1 L 5-24
art. DOMINOC2 L 25-49
art. DOMINOC3 L 50-74
art. DOMINOC4 L 75-100

Prof. 54 cm

art. DOMINOC5 L 5-24
art. DOMINOC6 L 25-49
art. DOMINOC7 L 50-74
art. DOMINOC8 L 75-100



La misura reale del cassetto vuoto è data dalla larghezza meno 7,6 cm.
Es. cassetto cm L 72 cm - misura del vuoto 64,4 cm.

*The actual size of the empty drawer is the length less 7,6 cm.
For example drawer measures L 72 cm - the usable empty space is 64,4 cm.*





CASSETTO INTERNO *_INTERNAL DRAWER*
L 90_H 9 cm



CASSETTO ESTERNO_DRAWER
L 90_H 18 cm

Potrete scoprire tutte le possibili combinazioni per la personalizzazione dei cassetti, in base alle dimensioni e ad ogni singola esigenza, consultando l'area dedicata alle attrezzature interne sul nostro sito internet www.antoniolupi.it.

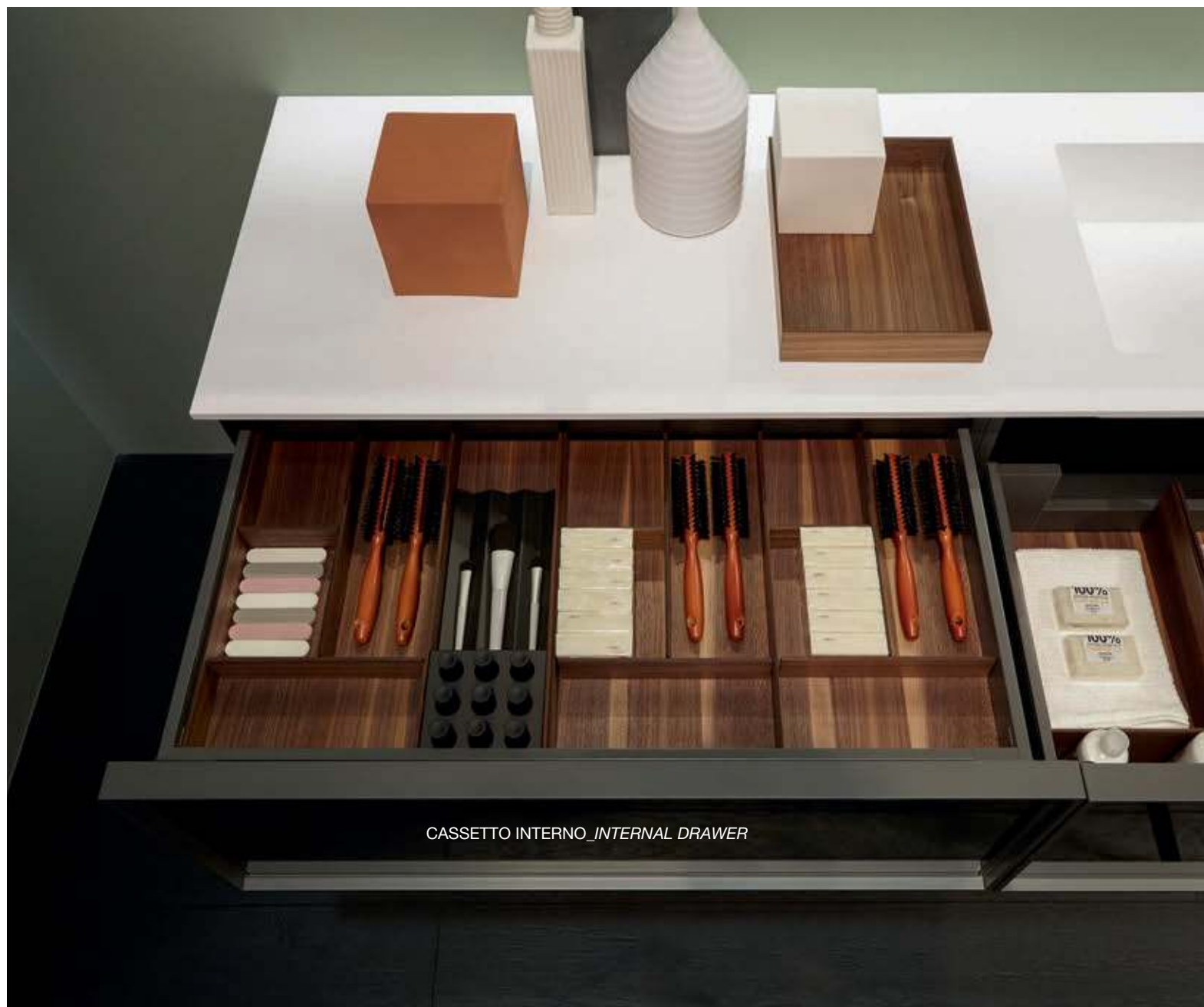

Cassetto interno opzionale art. SLIM54 con attrezzatura DOMINO

Internal optional drawer art. SLIM54 with accessories DOMINO

You can discover all the possible combinations for customizing the drawers, based on the size and each individual need, by consulting the area dedicated to internal equipment on our website www.antoniolupi.it.



BEMADE

2020

design_Carlo Colombo

Un perimetro rigoroso che delimita una superficie, una cornice che valorizza un'immagine, un segno che esprime il rigore creativo dell'uomo ed esalta il senso della misura, il valore delle proporzioni, la bellezza intrinseca dell'equilibrio.

Un profilo marcato, deciso, assoluto, è il tratto distintivo della collezione Bemade firmata Carlo Colombo.

Un segno grafico che diventa tratto distintivo del progetto per affermare uno stile, per disegnare un paesaggio domestico fatto di pieni e vuoti, di accostamenti cromatici ricercati, di riflessi e giochi di luci e ombre.

La collezione Bemade è l'evoluzione coerente di Bespoke, uno dei bestseller di antoniolupi, dalla quale eredita la purezza della forma e la flessibilità compositiva pur nel rispetto di un segno rigoroso ed essenziale.

L'evoluzione sta proprio nell'estremizzazione del concetto di cornice ma anche nella possibilità di offrire ancora maggiori possibilità di personalizzazione dei volumi per conferire identità allo spazio, per dialogare con gli elementi architettonici che caratterizzano l'ambiente bagno ma non solo.

Alle finiture della struttura già disponibili nel programma Bespoke (alluminio, bronzo, titanio, zirconio e champagne) si aggiungono ora il nero opaco ed il bianco opaco, in linea con le tendenze dell'interior contemporaneo per dialogare con le finiture matt degli altri elementi metallici o dei volumi ceramici.

O ancora all'ampia gamma di frontali anta (vetro argentato naturale/argentato fumè e bronzo/riflettente/acidato fumè, bronzo o retrolaccato nei colori/trasparente fumè e bronzo/cannettato trasparente e retrolaccato nei colori antoniolupi) si aggiunge anche la finitura in legno e l'aggiunta di vani a giorno che ampliano le modalità di impiego della serie per abbracciare l'ambiente living e portare in tutti gli spazi della casa lo stile inconfondibile di antoniolupi.

A rigorous perimeter that defines a surface, a frame that enhances an image, a sign that expresses man's creative rigor and increases the sense of measure, the value of proportions, the intrinsic beauty of balance.

A marked, decisive, absolute profile is the distinctive feature of the Bemade collection designed by Carlo Colombo.

A graphic sign that becomes a distinctive feature of the project to maintain a style, to draw a domestic landscape made of full and empty spaces, of refined chromatic combinations, of reflections and plays of lights and shadows.

The Bemade collection is the coherent evolution of Bespoke, one of antoniolupi's bestsellers, from which it inherits the purity of form and compositional flexibility while respecting a rigorous and essential sign.

The evolution lies precisely in the concept of the frame but also in the possibility of offering even greater possibilities for customizing the volumes to give identity to the space, to dialogue with the architectural elements that characterize the bathroom environment and not only.

The finishes of the aluminum frame already available in the Bespoke program (bronze, titanium, zirconium and champagne) are now joined by matt black and matt white, in line with the trends of contemporary interior to dialogue with the matt finishes of the other metal elements or ceramic volumes.

The wide range of glass fronts (natural silver / smoked and bronze silver / reflective / etched smoked or bronze glass, or back-lacquered in all the colors / smoked and bronze transparent / clear ribbed and back-lacquered in the antoniolupi colors) as well as the wooden finishes and the addition of open compartments that expand the way the series is used to embrace the living environment and bring the unmistakable style of antoniolupi to all spaces in the home.









Questa composizione comprende lo specchio art. WHITE309, L 54 cm H 75 cm, rubinetteria INDIGO art. ND921, art. ND601, finitura nero opaco. Il mobile è composto da un porta lavabo art. DAL290 e una base art. DAB254 entrambe hanno la struttura Rovere ardesia, cornice finitura nero opaco, frontale in vetro argentato fumé; basi con vani a giorno, due art. DBG254 e due art. DBG290, sono realizzate in finitura Rovere ardesia complete di illuminazione interna a led. Il top, in marmo Nero Marquinia art. MR154, con misure su richiesta, L 288 cm P 54 cm Sp 2 cm, ospita il lavabo da appoggio art. SENSOC in Cristalmoood colore Gran Cru. La colonna, art. DC3790 L 90 cm H 175 cm P 21,6 cm, completa di illuminazione interna a led, ha la struttura Rovere ardesia, cornice finitura nero opaco, frontale in vetro riflettente fumé. A parete la carta da parati TRALERIGHE, art. Q10P.



This composition includes the mirror art. WHITE309, L 54 cm H 75 cm, INDIGO taps art. ND921 and art. ND601, in a matt black finish. The furniture consists of a sink unit art. DAL290 and a cabinet art. DAB254 both with Rovere Ardesia structure, frame in a matt black finish, fumè mirrored glass front; cabinets with open compartments, two art. DBG254 and two art. DBG290, with Rovere Ardesia finish complete with internal led lighting. The top is in Nero Marquinia marble art. MR154, with measurements on request, L 288 cm D 54 cm and 2 cm thick, sink art. SENSOC in Cristalmood color Gran Cru. The column, art. DC3790 L 90 cm H 175 cm D 21,6 cm, complete with internal led lighting and Rovere Ardesia structure, matt black finish frame, front in fumè reflective glass. On the wall the TRALERIGHE wallpaper, art. Q10P.



La composizione si arricchisce di optional: art. BARRALED è un'illuminazione a led, applicata sotto al porta lavabo e alle basi, mentre gli elementi con vani a giorno hanno un'ulteriore illuminazione a led interna, completamente indipendente dalla prima.

The composition is enriched with optional: art. BARRALED is a strip of LED lighting applied under the sink unit and the cabinets, while the elements with open compartments have additional internal LED lighting, completely independent from the first.





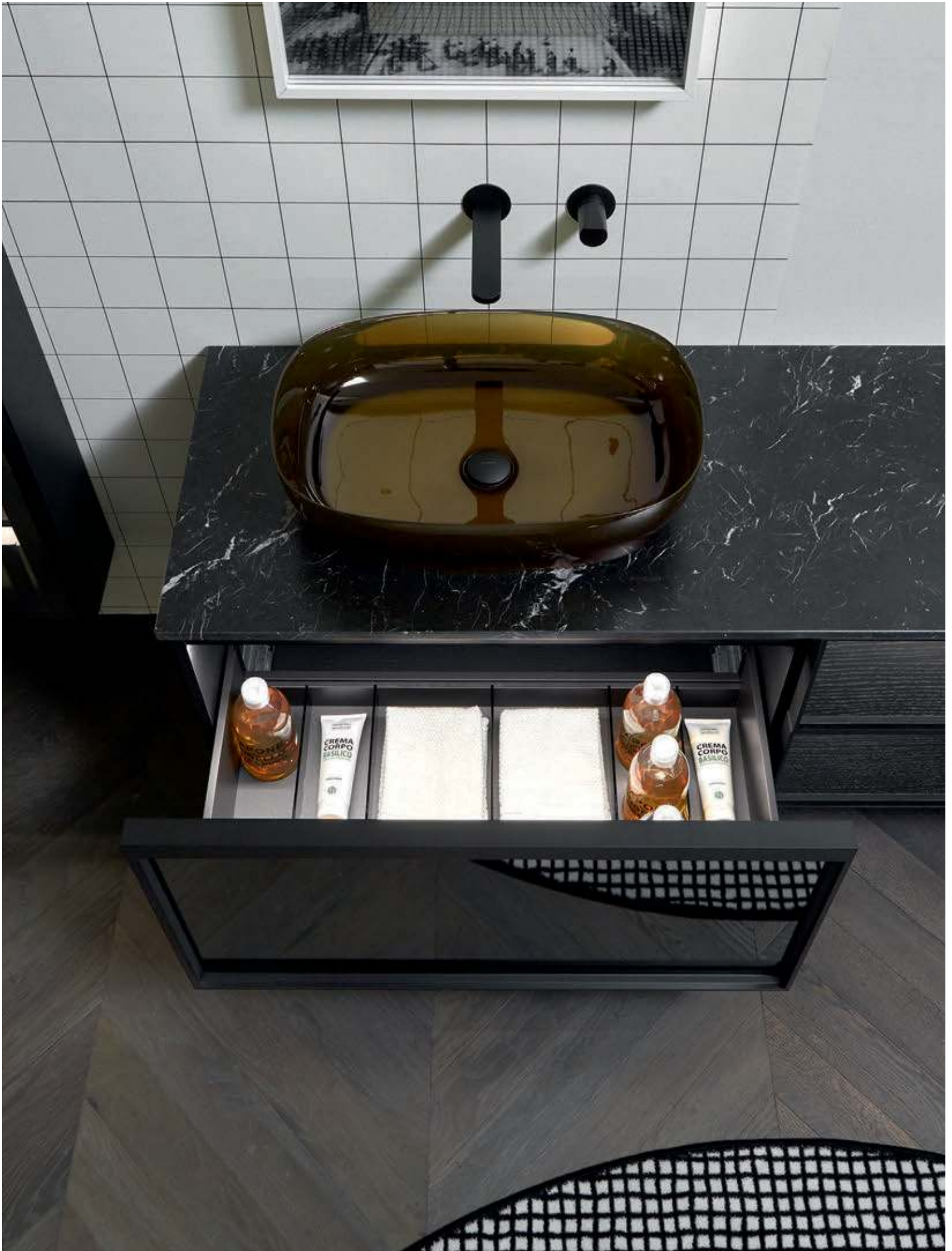







L'illuminazione a led può essere integrata anche su ogni singolo ripiano della colonna.

LED lighting can also be integrated in each single shelf of the high cabinet.



Nella versione con frontale anta in essenza di legno o verniciato, è possibile richiedere l'inserimento dello specchio all'interno dell'anta.

In the version with wood essence or laquered door front, it is possible to request the insertion of the mirror inside the door.



Piatto doccia SUMISURA art. SM_COMBI90, L 162 cm P 90 cm in Flumood Bianco con box doccia COMBI art. COMBI90, L 162 cm P 90 cm H 195, in vetro trasparente extrachiari e profili finitura nero opaco.
Al suo interno, soffione art. AZIMUT finitura grafite; deviatore art. MAYDAYD Acciaio Satinato e miscelatore monocomando art. MAYDAY verniciato bianco; doccia art. FILTRO in Acciaio Satinato e flessibile bianco.
A destra del box doccia, scaldasalviette art. STECCA60 L 60 cm P 7 cm H 12 cm e art. STECCA90 L 90 cm P 7 cm H 12 cm, entrambi verniciati Bianco RAL 9010.
Vasca art. REFLEX in Cristalmoed Gran Cru con rubinetteria INDIGO finitura bianco opaco art. ND903.
Carta da parati TRALERIGHE art. Q10N.



SUMISURA shower tray art. SM_COMBI90, L 162 cm D 90 cm in white Flumood with COMBI shower enclosure art. COMBI90, L 162 cm D 90 cm H 195, in extra-clear transparent glass and matt black finish profiles. Inside, shower head art. AZIMUT in a graphite finish; diverter art. MAYDAYD in Satin Steel and single lever mixer art. MAYDAY painted white; hand shower art. FILTER in satin steel and white flexible hose. To the right of the shower enclosure, towel warmer art. STECCA60 L 60 cm D 7 cm H 12 cm and art. STECCA90 L 90 cm D 7 cm H 12 cm, both painted white RAL 9010. Bathtub art. REFLEX in Cristalmood Gran Cru with Indigo tap in Matt White finish art. ND903. TRALERIGHE wallpaper, art. Q10N.





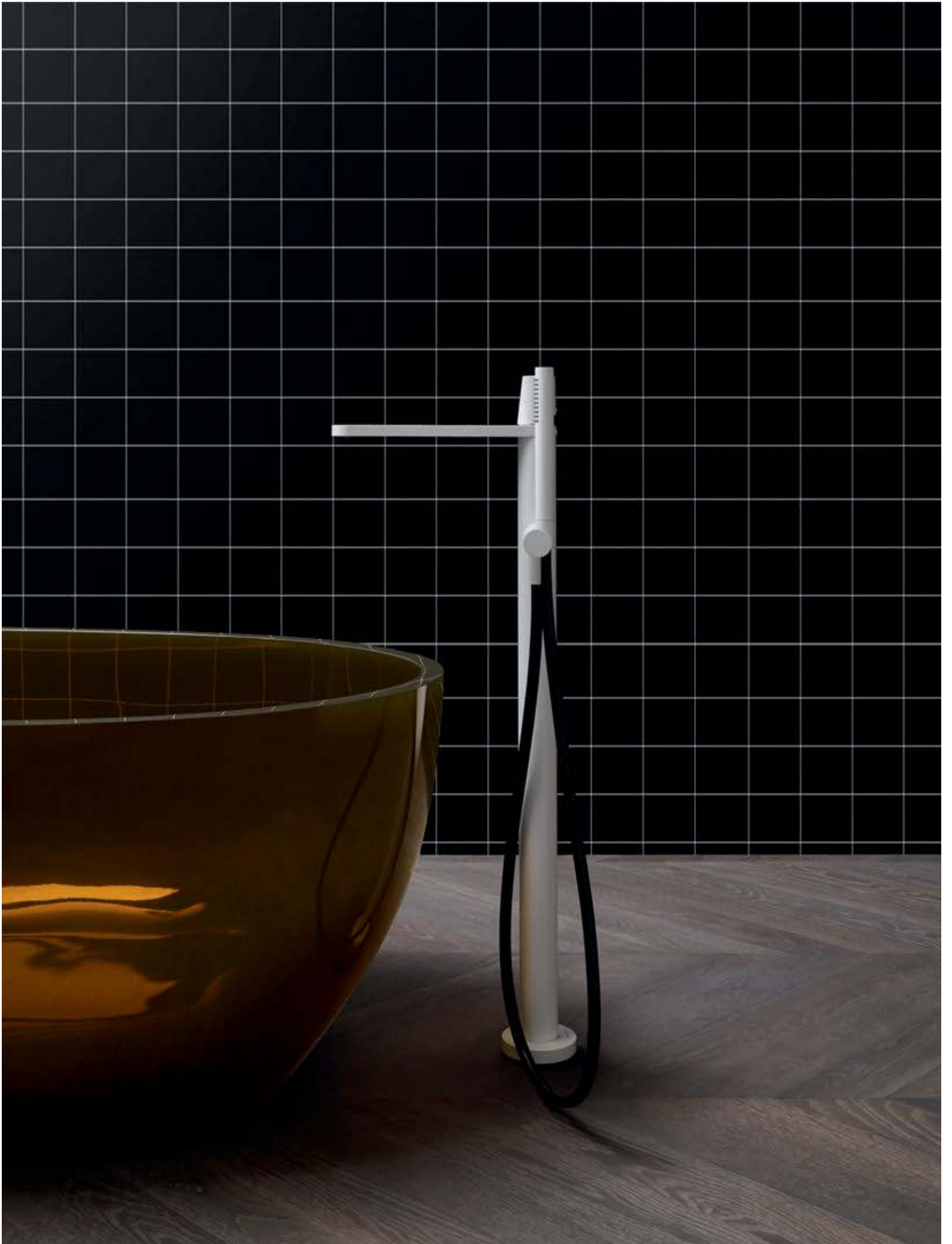









Questa composizione comprende lo specchio retroilluminato art. DISTINTO275W, L 225 cm H 75 cm, rubinetteria INDIGO art. ND921, art. ND601, finitura bianco opaco.

Il mobile è composto da due porta lavabi art. DIL290 e una base art. DIB245, struttura verniciata Bianco goffrato, cornice finitura bianco opaco, frontale in vetro acidato laccato Bianco.

Il top, in Marmo Carrara art. MR154 L 225 cm P 54 cm Sp 2 cm, ospita due lavabi da appoggio art. FONTE in Marmo Carrara.

La composizione è arricchita dall'illuminazione a led optional art. BARRALED, applicata sotto la composizione.

Carta da parati TRALERIGHE, art. A2P. Tappeto della collezione TRAMATO art. TR710 L 200 cm P 200 cm.

This composition includes the backlit mirror art. DISTINTO275W, L 225 cm H 75 cm, INDIGO taps art. ND921 and art. ND601, in matt white finish.

The cabinet consists of two sink units art. DIL290 and a cabinet art. DIB245, embossed white painted structure, finishing frame matt white, front in white lacquered acid-etched glass.

The top, in Carrara marble art. MR154 L 225 cm D 54 cm and 2 cm thick, two countertop sinks art. FONTE in Carrara marble.

The composition is enriched by an optional strip of LED lighting art. BARRALED, applied under the composition.

TRALERIGHE wallpaper, art. A2P. Carpet of the TRAMATO collection art. TR710 L 200 cm D 200 cm.









Sotto alla composizione, art. BARRALED illumina in maniera diffusa e discreta l'ambiente, mentre all'interno delle basi l'illuminazione, art. LED_IN, si accende aprendo il cassetto.



Under the composition, art. BARRALED illuminates the environment in a diffused and discreet way, while inside the cabinets the lighting, art. LED_IN, lights up when the drawer is opened.



Le finiture dei frontali e delle cornici possono essere personalizzate, scegliendo dalla gamma della nostra cartella colori oppure con colori a campione.



The finishes of the fronts and frames can be customized, choosing from the range of our color chart or with sample colors.



Le finiture dei frontali e delle cornici possono essere personalizzate, scegliendo dalla gamma della nostra cartella colori oppure con colori a campione.



The finishes of the fronts and frames can be customized, choosing from the range of our color chart or with sample colors.



Le finiture dei frontali e delle cornici possono essere personalizzate, scegliendo dalla gamma della nostra cartella colori oppure con colori a campione.



The finishes of the fronts and frames can be customized, choosing from the range of our color chart or with sample colors.



Le finiture dei frontali e delle cornici possono essere personalizzate, scegliendo dalla gamma della nostra cartella colori oppure con colori a campione.



The finishes of the fronts and frames can be customized, choosing from the range of our color chart or with sample colors.



Questa composizione comprende lo specchio art. TRATTEGGIO, L 36 cm H 108 cm, rubinetteria INDIGO art. ND921, art. ND601, finitura bianco opaco.

Il pensile a giorno art. DEG890, L 90 cm P 14 cm H 25 cm, è in Rovere thermo.

Sotto al top scatolare art. BCS47 con lavabo integrato art. GRAFFIO4772, in Flumood Bianco, la base art. DBB2M90, con struttura verniciata Bianco gofrato, cornice finitura bianco opaco e frontale in Rovere thermo.

Mensola da incasso a parete in alluminio bianco art. OMBRAL, L 180 cm completa di portasalviette bianco art. OMBRAPS27.

La carta da parati TRALERIGHE art. Q1P.



This composition includes the mirror art. TRATTEGGIO, L 36 cm H 108 cm, INDIGO taps art. ND921 and art. ND601, matt white finish.

The open wall unit art. DEG890, L 90 cm D 14 cm H 25 cm, is in Rovere thermo. Under the boxy top art. BCS47 with integrated washbasin art. GRAFFIO4772, in white Flumood, the cabinet art. DBB2M90, with structure lacquered white embossed, matt white finish frame and Rovere thermo front. Recessed wall shelf in white aluminum art. OMBRAL, L 180 cm complete with white towel holder art. OMBRAP27. The TRALERIGHE wallpaper, art. Q1P.





Il top scatolare in Flumood Bianco art. BCS47, nella misura di L 216 cm P 47 cm Sp 12,5 cm, ospita il nuovo lavabo integrato art. GRAFFIO4772.

The boxy top in white Flumood art. BCS47, in the measure of L 216 cm D 47 cm and 12,5 cm thick, houses the new integrated sink art. GRAFFIO4772.







Nella foto in alto e a destra, pensile a giorno art. DEG890, L 90 cm P 14 cm H 25 cm, in Rovere thermo.

In the photo above and on the right, open wall unit art. DEG890, L 90 cm D 14 cm H 25 cm, in Rovere thermo.









La composizione è arricchita dall'aggiunta di optional: art. BARRALED applicata sotto la composizione, art. LED_IN per l'interno delle basi e un'ulteriore illuminazione inserita nelle basi con vani a giorno.



The composition is enriched by the addition of optional: art. BARRALED applied under the composition, art. LED_IN for the interior of the cabinets and an additional lighting inserted in the cabinets with open compartments.



Questa composizione comprende specchi art. WHITE310, L 54 cm H 75 cm e rubinetteria INDIGO in finitura bianco opaco art. ND921 e art. ND601. Il mobile è composto da due porta lavabi art. DIL290 con struttura verniciata Bianco goffrato, cornice finitura bianco opaco, frontale in vetro trasparente cannettato e due basi con vani a giorno art. DIG245. La composizione si completa di illuminazione interna ed esterna a led. Sopra il top in Flumood colore Serena, art. BC154 L 270 cm P 54 cm Sp 1,2 cm, i lavabi da appoggio art. RIGATI45 in Marmo Carrara. La carta da parati TRALERIGHE art. V1P. Tappeto della collezione TRAMATO art. TR710 L 200 cm P 200 cm.

This composition includes mirrors art. WHITE310, L 54 cm H 75 cm and INDIGO taps in a matt white finish art. ND921 and art. ND601. The furniture consists of two sink units art. DIL290 with embossed white lacquered structure, matt white finish frame, front in a fluted transparent glass and two cabinets with open compartments art. DIG245. The composition is completed with internal lighting and external led. Above the top is in Flumood color Serena, art. BC154 L 270 cm D 54 cm 1,2 cm thick, the countertop sinks art. RIGATI45 in Marble Carrara. The TRALERIGHE wallpaper art. V1P. Carpet of the TRAMATO collection art. TR710 L 200 cm D 200 cm.









Questa composizione è composta dallo specchio retroilluminato della collezione SPECCHIDICARTA art. SDC10, L 60 cm H 81,8 cm, rubinetteria INDIGO art. ND921, art. ND601, finitura bianco opaco.

Il mobile è formato da un porta lavabo art. DIL254 e tre basi art. DIB254 con struttura Skin cenere, fianchi personalizzati in Rovere ardesia, cornice finitura bianco opaco, frontale in Rovere ardesia; corredata di illuminazione a led interna ed esterna optional.

Il top è in vetro acidato colore Nero art. 910, L 216 cm P 54 cm Sp 1,2 cm, sopra il lavabo da appoggio art. RIGATI60 in marmo Nero Marquina.

Sulle pareti le carte da parati della collezione TRALERIGHE in abbinamento al tappeto TRAMATO art. TR655 L 300 cm P 170 cm.



This composition is composed of the backlit mirror of the SPECCHIDICARTA collection art. SDC10, L 60 cm H 81,8 cm, INDIGO taps art. ND921 and art. ND601 in matt white finish. The furniture consists of a sink unit art. DIL254 and three cabinets art. DIB254 with Skin cenere structure, customized sides in Rovere ardesia, matt white finish frame, Rovere ardesia front; equipped with optional internal and external LED lighting. The top is in black etched glass art. 910, L 216 cm D 54 cm 1.2 cm thick, above the countertop sink art. RIGATI60 in Nero Marquinia marble. On the walls the wallpapers of the TRALERIGHE collection in combination with the TRAMATO carpet art. TR655 L 300 cm D 170 cm.





In questa immagine, particolare dello specchio collezione SPECCHIDICARTA art. SDC10, L 60 cm H 81,8 cm, lavabo da appoggio art. RIGATI60 in marmo Nero Marquinia, rubinetteria INDIGO art. ND921, art. ND601, finitura bianco opaco e carta da parati TRALERIGHE, art. V1N.

In this image, detail of the mirror collection SPECCHIDICARTA art. SDC10, L 60 cm H 81.8 cm, countertop sink art. RIGATI60 in Nero Marquinia marble, INDIGO taps art. ND921 and art. ND601, in matt white finish and TRALERIGHE wallpaper, art. V1N.

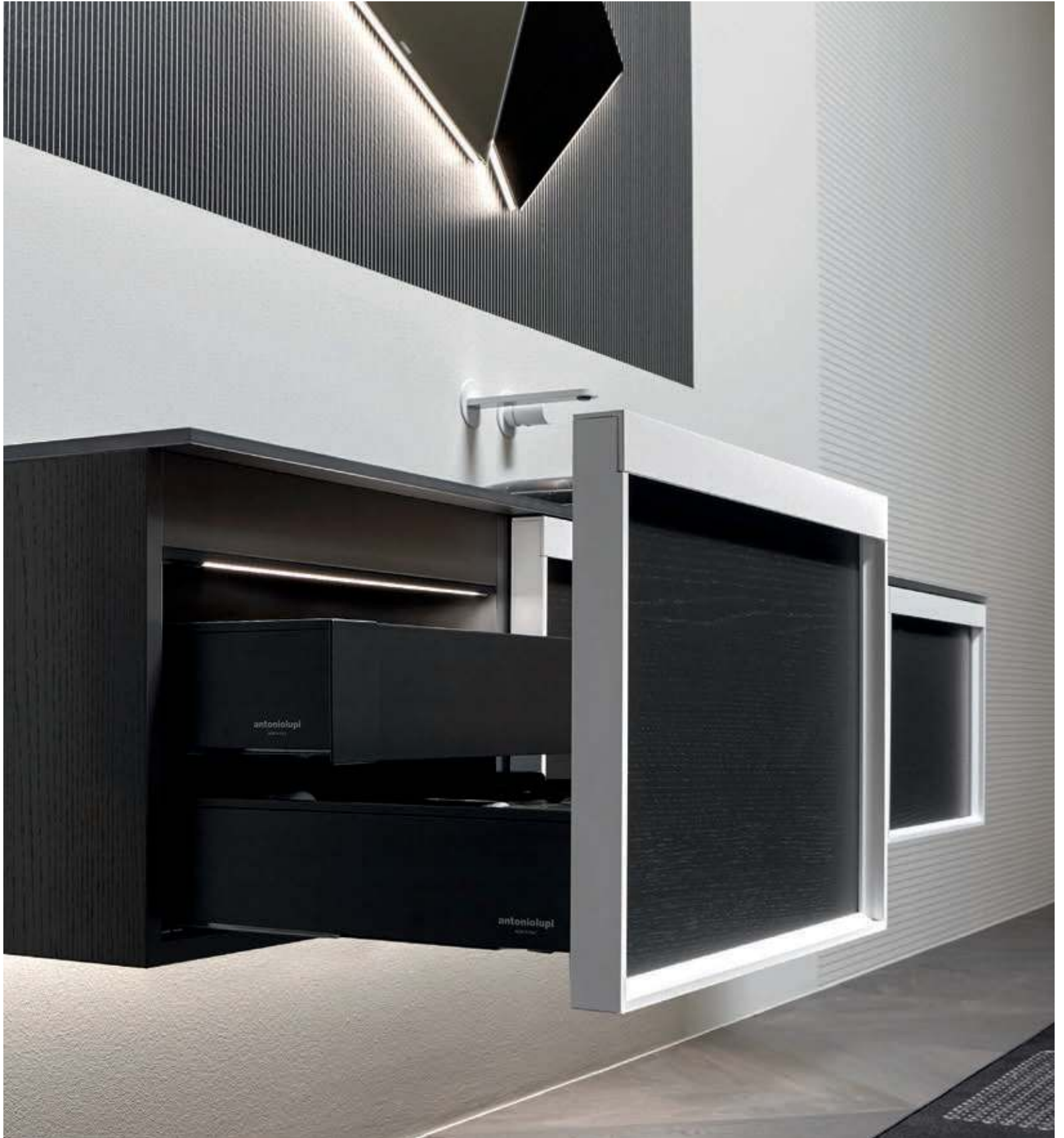

Cassetto interno opzionale art. SLIM54 e attrezzature STRATO con divisori in vetro fumè. Illuminazione interna a led optional art. LED_IN.

Internal optional drawer art. SLIM54 and accessories STRATO with dividers in fumè glass. Optional internal LED lighting art. LED_IN.

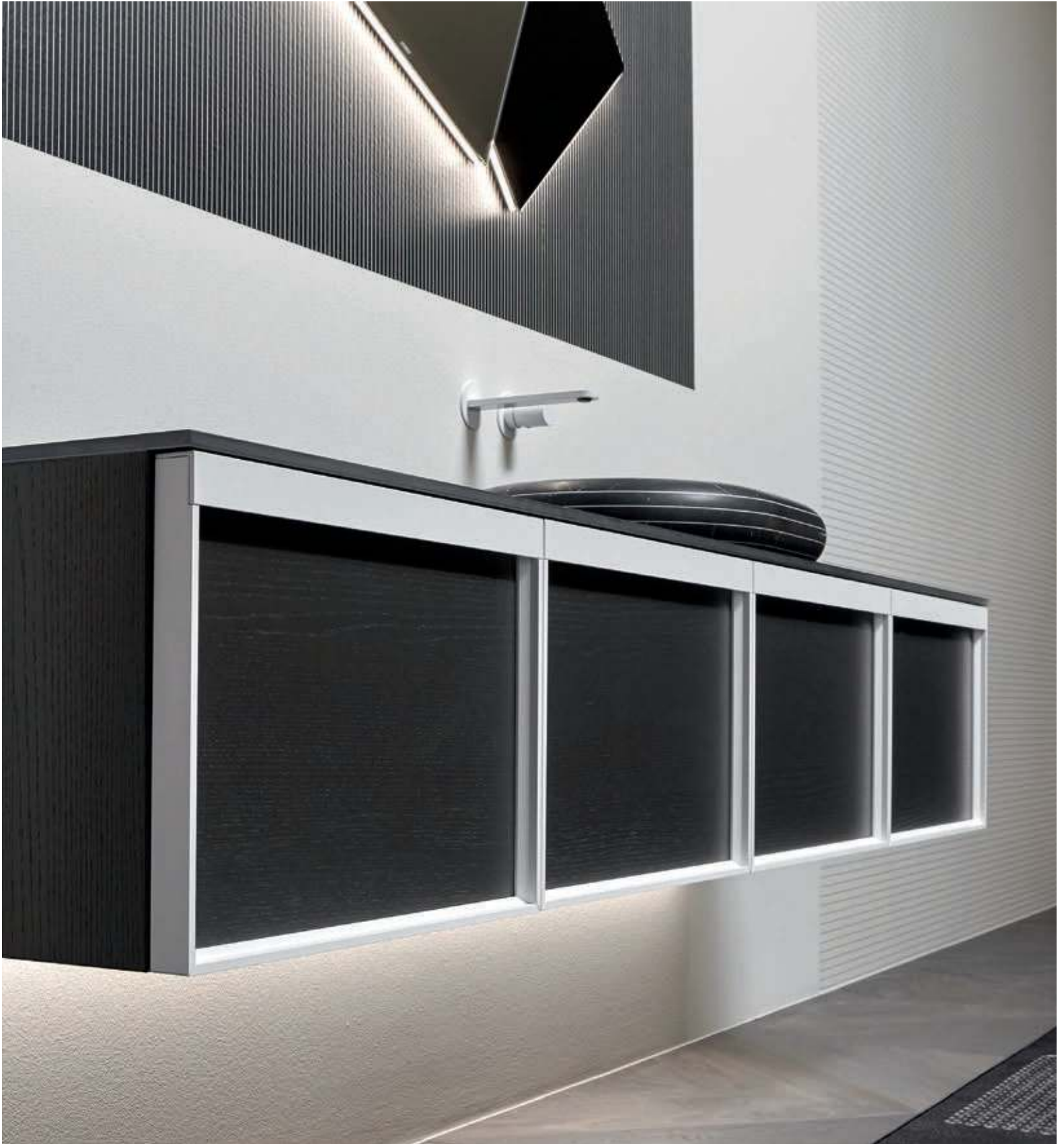







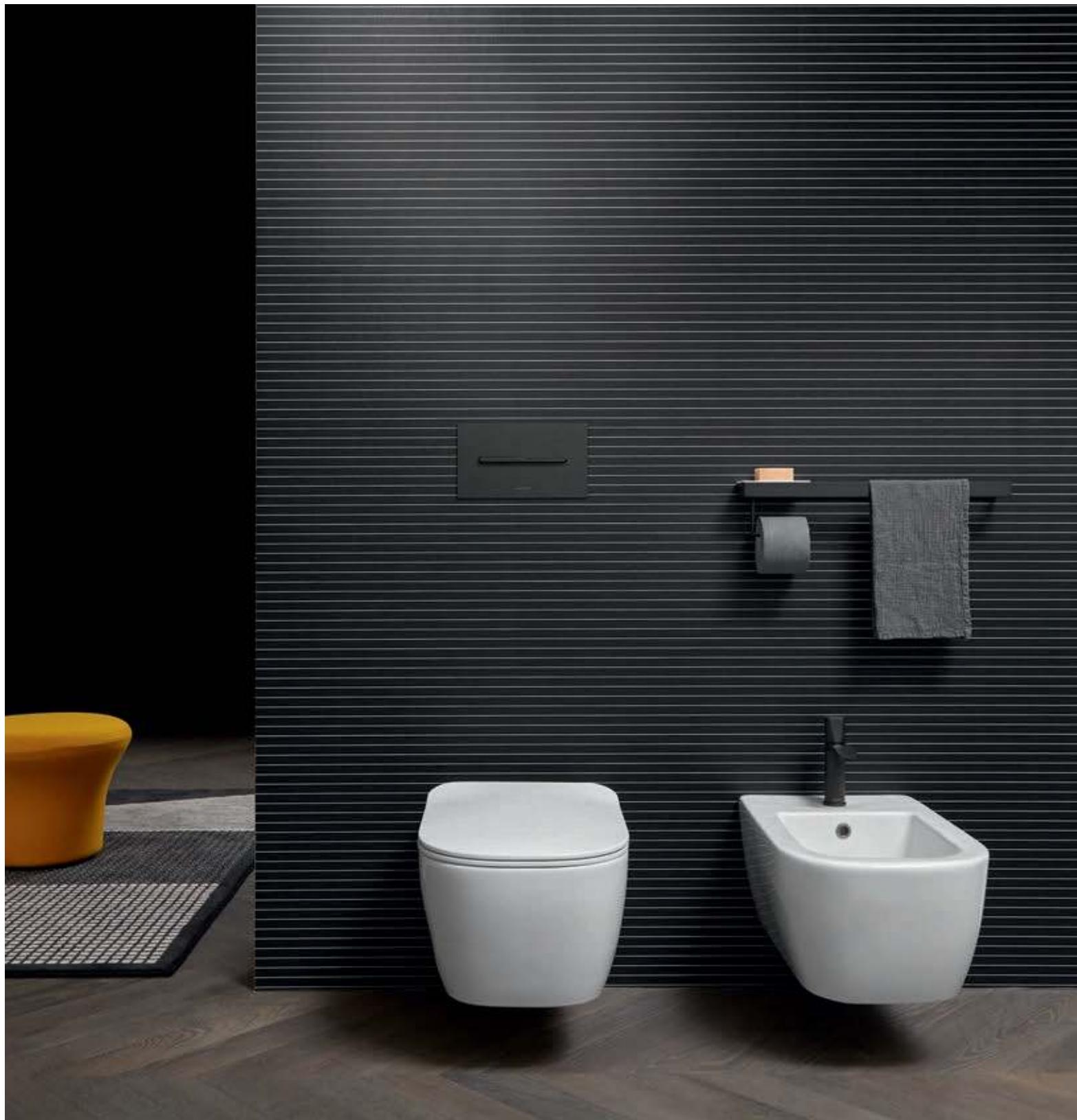

La composizione prevede i sanitari art. KOMODO1 e art. KOMODO2 in ceramica lucida, rubinetteria INDIGO art. ND400 e placca di comando art. ONDA in finitura grafite, portasalviette art.PLAY54, finitura Bronzo e pianetto in Corian con portarotolo art. PLAY2. La carta da parati TRALERIGHE è art. O2N.

The composition includes sanitary ware art. KOMODO1 and art. KOMODO2 in polished ceramic, INDIGO tap art. ND400 and flush plate art. ONDA in a graphite finish, towel holder art. PLAY54, bronze finish and shelf in Corian with paper roll holder art. PLAY2. The TRALERIGHE wallpaper is art. O2N.









Le finiture dei frontali e delle cornici possono essere personalizzate, scegliendo dalla gamma della nostra cartella colori oppure con colori a campione.

The finishes of the fronts and frames can be customized, choosing from the range of our color chart or with sample colors.





Questa composizione comprende lo specchio retroilluminato art. SUPERLUNA120W, Ø 120 cm, rubinetteria INDIGO art. ND921 e art. ND601 in finitura nero opaco. Il mobile è composto da un porta lavabo art. DALM690, una base art. DABM245 e due basi art. DABM645, il tutto in finitura Skin cenere con fianchi personalizzati in Rovere ardesia, cornice finitura nero opaco, frontali in vetro argentato fumé e Rovere ardesia; completa di illuminazione a led optional interna ed esterna. Il top in Flumood Bianco art. BC147, L 225 cm P 47 cm Sp 1,2 cm, ospita il lavabo integrato art. PODIO90 completo di pianetto copripiletta art. PIANETTO5. La carta da parati TRALERIGHE è art. A2N.

This composition includes the backlit mirror art. SUPERLUNA120W, Ø 120 cm, INDIGO taps art. ND921 and art. ND601 in matt black finish. The cabinet consists of a sink unit art. DALM690, a cabinet art. DABM245 and two cabinets art. DABM645, all in Skin cenere finish with customized sides in Rovere ardesia, matt black finish frame, glass fronts fumé mirrored and Rovere ardesia; complete with optional internal and external LED lighting. The top is in white Flumood art. BC147, L 225 cm D 47 cm and 1,2 cm thick, houses the integrated sink art. PODIO90 complete with drain cover art. PIANETTO5. The TRALERIGHE wallpaper is art. A2N.



Top in Flumood Bianco art. BC147 L 225 cm P 47 cm Sp 1,2 cm con lavabo integrato art. PODIO90, completo di pianetto copripiletta art. PIANETTO5; quest'ultimo può essere utilizzato anche come portaoggetti.



Top is in white Flumood art. BC147 L 225 cm D 47 cm and 1,2 cm thick with integrated sink art. PODIO90, complete with drain cover art. PIANETTO5; the latter can also be used as a support.

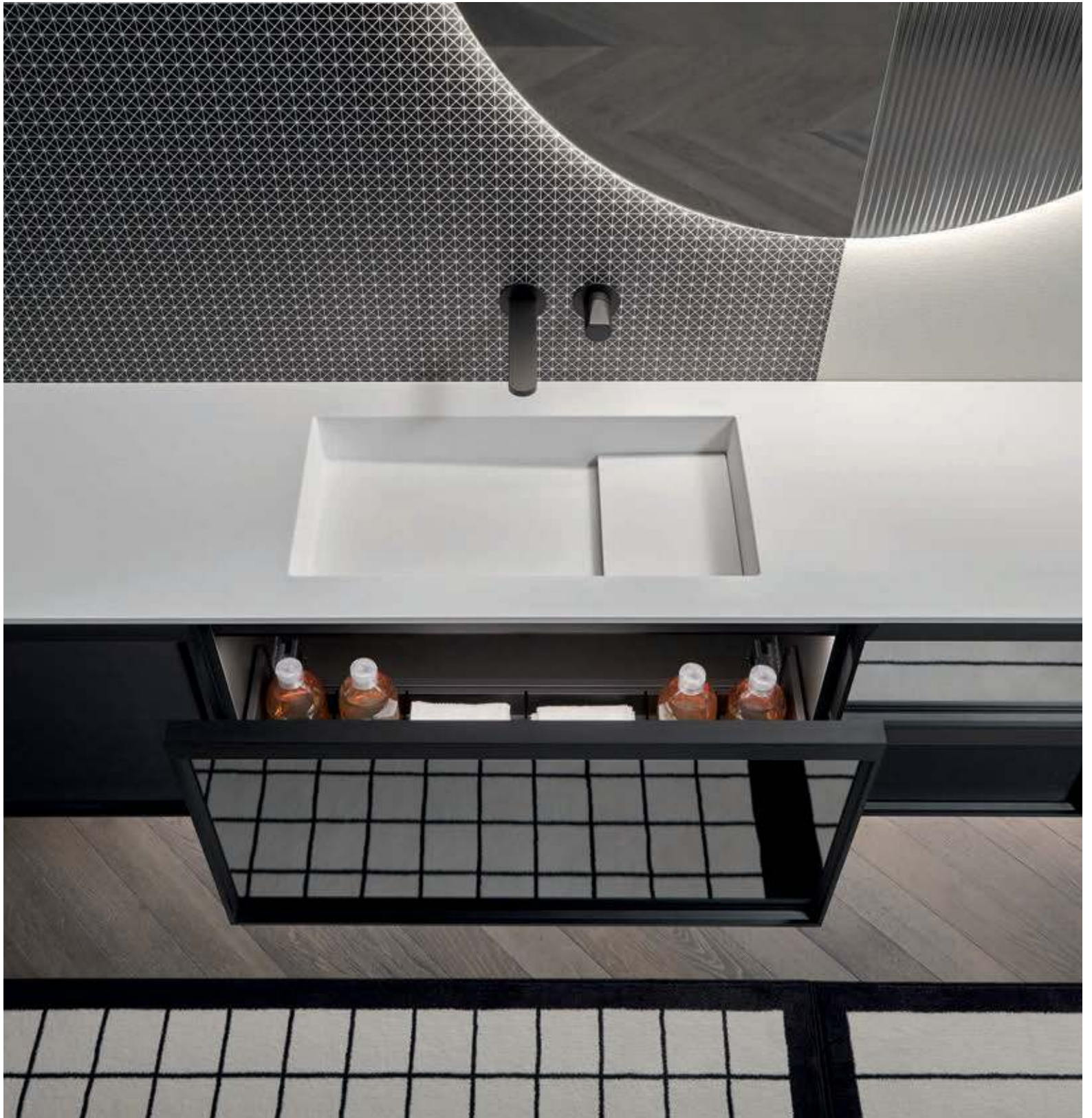

Top in Flumood Bianco art. BC147 L 225 cm P 47 cm Sp 1,2 cm con lavabo integrato art. PODIO90, completo di pianetto copripiletta art. PIANETTO5; quest'ultimo può essere utilizzato anche come portaoggetti.



Top is in white Flumood art. BC147 L 225 cm D 47 cm and 1,2 cm thick with integrated sink art. PODIO90, complete with drain cover art. PIANETTO5; the latter can also be used as a support.



Questa composizione comprende il lavabo freestanding ALBUME, con lavabo in Cristalmood colore Fumè art. ALBUME10 e colonna in Rovere thermo art. ALBUME30; rubinetteria INDIGO art. ND902 finitura grafite.

La composizione a parete è composta da due colonne art. DC1736 destra e sinistra, con struttura in Rovere thermo, cornice finitura Zirconio e frontale in vetro argentato bronzo, al centro una colonna a giorno art. DCG1736 con struttura in Rovere thermo.

La carta da parati TRALERIGHE è art. V1P in primo piano, sullo sfondo art. A2N.

Tappeti della collezione TRAMATO art. TR440 a sinistra e art. TR441 a destra, entrambi L 200 cm P 85 cm.



This composition includes the ALBUME freestanding sink, with Fumè Cristalmood sink art. ALBUME10 and base in Rovere thermo art. ALBUME30; INDIGO tap art. ND902 graphite finish. The wall composition consists of two high cabinets art. DC1736 left and right, with Rovere thermo structure, finishing frame in Zirconium and front in Bronze mirrored glass, in the center an open high cabinet art. DCG1736 with Rovere thermo structure. The TRALERIGHE wallpaper is art. V1P in the foreground, in the background art. A2N. Rugs from the TRAMATO collection art. TR440 on the left and art. TR441 on the right, both L 200 cm D 85 cm.







La composizione è composta da: mobile di sinistra con struttura verniciata Grigio smog gofrato, cornice verniciata Grigio smog gofrato e frontale in vetro acidato laccato Grigio smog, sopra top in Flumood Serena con lavabo integrato NIDO, specchio della collezione SPECCHIDICARTA e rubinetteria INDIGO in finitura nero opaco; il mobile di destra invece ha la struttura verniciata Nero gofrato, cornice finitura nero opaco e frontale in vetro acidato Nero, sopra top in Flumood Serena con lavabo integrato GRAFFIO, specchio della collezione SPECCHIDICARTA e rubinetteria INDIGO finitura nero opaco. Al centro, colonna a due ante con struttura verniciata Grigio smog gofrato, cornice verniciata Grigio smog gofrato e frontale in vetro riflettente fumé.



The composition consists of: left cabinet with embossed Grigio Smog lacquered structure, embossed Grigio Smog lacquered frame and front in Grigio Smog lacquered acid-etched glass, top in Flumood Serena with integrated NIDO sink, SPECCHIDICARTA collection and INDIGO tap in matt black finish; the cabinet on the right has an embossed black lacquered structure, matt black finish frame and black acid-etched glass front, top in Flumood Serena with integrated GRAFFIO sink. In the center, high cabinet with two doors embossed Grigio smog lacquered structure, embossed Grigio smog lacquered frame and front in fumè reflective glass.

“TONO SU TONO”

“TONE ON TONE”

Una perfetta integrazione cromatica per un total look assoluto dell'ambiente bagno, un “velo” di colore che ricopre in modo uniforme tutti gli elementi, per esprimere al meglio uno stile e un carattere identitario. Grazie al Colormood il bagno antoniolupi si tinge di colore in tutti i suoi protagonisti più significativi, costruisce un senso di appartenenza che deriva da una coerenza estetica che coinvolge volumi scultorei e articolati ma anche forme semplici e accessori complementari.

A perfect chromatic integration for an absolute total look of the bathroom, a “veil” of color that uniformly covers all the elements, to best express a style and an identity. Thanks to Colormood, the antoniolupi bathroom is tinged with color in all its most significant protagonists, building a sense of belonging that derives from an aesthetic coherence that involves sculptural and arctic volumes but also simple shapes and complementary accessories.





Nella foto a sinistra, la composizione è composta dallo specchio retroilluminato della collezione SPECCHIDICARTA art. SDC11, L 58,9 cm H 85,8 cm, rubinetteria INDIGO art. ND921, art. ND601, finitura nero opaco. Il mobile è formato da un porta lavabo art. DAL190 e una base art. DAB590 con struttura verniciata Grigio smog goffrato, cornice verniciata Grigio smog goffrato e frontale in vetro acidato laccato Grigio smog. Nella foto in alto, top in Flumood Serena art. BC140, L 180 cm P 40 cm Sp 1,2 cm, con lavabo integrato art. NIDO472 completo di pianetto copripiletta art. PIANETTO4.

In the photo on the left, the composition is made up of the backlit mirror from the SPECCHIDICARTA collection art. SDC11, L 58,9 cm H 85,8 cm, INDIGO taps art. ND921 and art. ND601, matt black finish. The furniture consists of a sink unit art. DAL190 and a cabinet art. DAB590 with embossed Grigio smog lacquered structure, embossed Grigio smog lacquered frame and front Grigio smog lacquered etched glass. In the photo above, top in Flumood Serena art. BC140, L 180 cm D 40 cm and 1,2 cm thick, with integrated sink art. NIDO472 complete with drain cover PIANETTO 4.



Le finiture dei frontali e delle cornici possono essere personalizzate, scegliendo dalla gamma della nostra cartella colori oppure con colori a campione.



The finishes of the fronts and frames can be customized, choosing from the range of our color chart or with sample colors.



A destra la composizione è composta dallo specchio retroilluminato della collezione SPECCHIDICARTA art. SDC12, L 74,3 cm H 74,3 cm, rubinetteria INDIGO art. ND301 in finitura nero opaco. Il mobile è formato da un porta lavabo art. DAL172, una base art. DAB172 con struttura verniciata Nero gofrato, cornice finitura nero opaco e frontale in vetro acidato laccato Nero e due basi con vani a giorno (foto in alto) art. DBG154.

On the right, the composition is composed of the backlit mirror from the SPECCHIDICARTA collection art. SDC12, L 74,3 cm H 74,3 cm, INDIGO tap art. ND301 in matt black finish. The furniture consists of a sink unit art. DAL172, a cabinet art. DAB172 with embossed Nero lacquered structure, matt black finish frame and Nero lacquered acid-etched glass front and two cabinets with open compartments (photo above) art. DBG154.







Top in Flumood Serena art. BC140, L 198 cm P 40 cm Sp 1,2 cm, con lavabo integrato art. GRAFFIO4072.

Top in Flumood Serena art. BC140, L 198 cm D 40 cm and 1,2 cm thick, with integrated sink art. GRAFFIO4072.



Nella foto in alto e a destra, colonna art. DC3772 con struttura verniciata Grigio smog gofrato, cornice verniciata Grigio smog gofrato e frontale in vetro riflettente fumè.

In the photo above and on the right, high cabinet art. DC3772 with embossed Grigio smog lacquered structure, embossed Grigio smog lacquered frame and front in fumè reflective glass.













Questa composizione comprende due specchi retroilluminati art. NEUTROLED75W, L 144 cm H 75 cm, completi di lampada art. LUCENTINA135 L 135 cm; rubinetteria INDIGO art. ND301 finitura nero opaco. Il mobile è composto da due porta lavabi art. DALM2108 e due basi art. DABM654, struttura Skin cenere, cornice finitura nero opaco, frontale in Rovere thermo. Il top in Colormood Basalto art. BC147, con misure su richiesta L 324 cm P 47 cm Sp 1,2 cm, ospita due lavabi integrati art. GRAFFIO4772. La composizione si completa di optional: illuminazione a led interna ed esterna, attrezzatura interna per cassetti STRATO, e di due coppie di bicchieri art. PERCEZIONE. Carta da parati TRALERIGHE art. O10N. Tappeti della collezione TRAMATO art. TR650 L 240 cm P 67 cm e art. TR651 L 240 cm P 120 cm.

Nella foto a destra la colonna, art. DC3790 L 90 cm H 175 cm P 21,6 cm, ha struttura Rovere thermo, cornice finitura nero opaco e frontale in vetro riflettente fumè; si completa inoltre di illuminazione interna a led.

This composition is made up of two backlit mirrors art. NEUTROLED75W, L 144 cm H 75 cm complete with lamp art. LUCENTINA135 L 135 cm; INDIGO taps art. ND301 matt black finish.

The furniture is made up of two sink units art. DALM2108 and two cabinets art. DABM654, structure in Skin cenere, frame matt black, fronts in Rovere thermo. The top is in Colormood Basalto art. BC147 with sizes to measure L 324 cm D 47 cm and 1,2 cm thick and houses two integrated sinks art. GRAFFIO4772. The composition is complete with optional: internal and external led lighting, internal drawer accessories STRATO and two glasses art. PERCEZIONE.

Wallpaper TRALERIGHE art. O10N. Carpet from the TRAMATO collection art. TR650 L 240 cm D 67 cm and art. TR654 L 240 cm D 120 cm

On the right high cabinet art. DC3790 L 90 cm H 175 cm D 21,6 cm has a Rovere thermo structure, frame in matt black and front in reflective fumè glass complete with internal led lighting.







Questa composizione comprende lo specchio art. TRATTEGGIO, L 36 cm H 108; rubinetteria INDIGO art. ND921 e art. ND601 finitura grafite. Il mobile è composto da un porta lavabo art. DILM290 e due basi art. DIBM245, struttura Skin cenere, cornice finitura Skin cenere, frontale in vetro argentato bronzo. Il top in Colormood Smoke, art. BC147 L 180 cm P 47 cm Sp 1,2 cm, ospita il lavabo da appoggio art. SENSOC in Cristalmood Fumè. La composizione si completa di optional: illuminazione a led interna ed esterna, attrezzatura interna per cassetti STRATO. A parete pensile a giorno in finitura Skin cenere, art. DEG872 L 72 cm H 25 cm P 14 cm. Carta da parati TRALERIGHE, art. A2P e art. O1P. Tappeto della collezione TRAMATO art. TR650 L 240 cm P 67 cm.

This composition is made up of the mirror art. TRATEGGIO L 36 cm H 108; INDIGO tap series art. ND921 and art. ND601 graphite finish. The furniture is made up of sink unit art. DILM290 and two cabinets art. DIBM245, structure in Skin cenere, frame in Skin cenere, front in mirrored bronze glass. The top is in Colormood Smoke, art. BC147 L 180 cm D 47 cm and 1,2 cm thick houses a top mount sink art. SENSOC in Cristalmood Fumè. The composition is complete with optional: internal and external led lighting and internal drawer accessories STRATO. Wall hanging cabinet in Skin cenere art. DEG872 L 72 cm H 25 cm D 14 cm. Wallpaper TRALERIGHE art. A2P and art. O1P. Carpet from the TRAMATO collection art. TR650 L 240 cm D 67 cm.















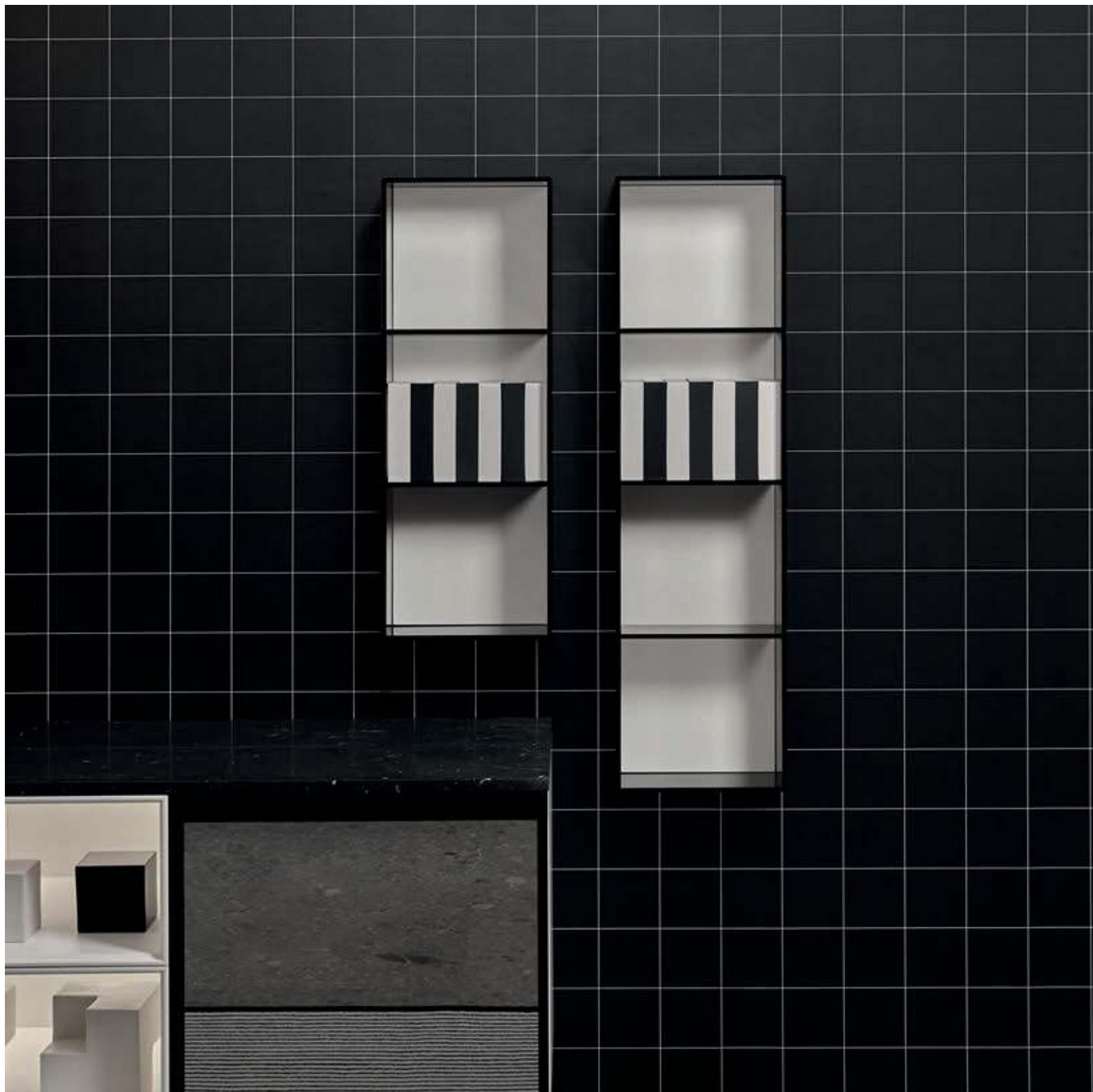

Questa composizione comprende lo specchio retroilluminato della collezione SPECCHIDICARTA art. SDC11, L 58,9 cm H 85,8 cm; rubinetteria INDIGO art. ND921 e art. ND601 finitura nero opaco.

Il mobile è composto da un porta lavabo, art. DAL290, e una base, art. DAB254, entrambi con struttura verniciata Bianco gofrato, cornice finitura nero opaco e frontali in vetro argentato fumè. Le basi con un vano a giorno, due art. DBG272 e due art. DBG236, hanno tutte struttura verniciata Bianco gofrato. Il top, in marmo Nero Marquinia art. MR154 L 252 cm P 54 cm Sp 2 cm, ospita il lavabo da appoggio art. SENSO in Colormood Basalto. A parete una colonna art. DC3772, con struttura verniciata Bianco gofrato, cornice finitura nero opaco e frontali in vetro riflettente fumè, e due pensili: un art. ICE8 L 27 cm H 75 cm P 14 cm e un art. ICE1 L 27 cm H 100 cm P 14 cm, entrambi in vetro fumè e schienale verniciato Bianco gofrato. La composizione si completa di optional: illuminazione a led interna ed esterna, attrezzatura interna per cassette STRATO.

Carta da parati TRALERIGHE, art. Q10N. Tappeti della collezione TRAMATO due art. TR250 L 200 cm P 132 cm.

This composition includes the backlit mirror of the SPECCHIDICARTA collection art. SDC11, L 58,9 cm H 85,8 cm; INDIGO tap series art. ND921 and art. ND601 matt black finish. The furniture is made up of a sink unit art. DAL290 and a cabinet art. DAB254 both with structure in lacquered embossed white, frame in matt black and front in mirrored fume glass. The two open cabinets art. DBG272 and two art. DBG236 are lacquered embossed white. The top in marble Nero Marquinia art. MR154 L 252 cm D 54 cm and 2 cm thick houses the top mount sink art. SENSO in Colormood Basalto. Wall cabinet art. DC3772 lacquered embossed white, frame in matt black and front in reflective fume glass and two wall cabinets art. ICE L 27 cm H 100 cm and D 14 cm both in fume glass and back lacquered embossed white. The composition is complete with optional: internal and external led lighting and internal drawer accessories STRATO. Wallpaper TRALERIGHE art. O10N. Carpets from the TRAMATO collection art. TR250 L 200 cm D 132 cm.



Le finiture dei frontali e delle cornici possono essere personalizzate, scegliendo dalla gamma della nostra cartella colori oppure con colori a campione.



The finishes of the fronts and frames can be customized, choosing from the range of our color chart or with sample colors.







Questa composizione comprende lo specchio retroilluminato Neutroled, con misure su richiesta, L 225 cm H 75 cm, con lampada art. LUCENTINA216, L 216 cm in alluminio verniciato nero; rubinetteria INDIGO art. ND921, art. ND601, finitura nero opaco. Il mobile è composto da due porta lavabi art. DIL290 e una base art. DIB245 con struttura in Skin cenere, cornice finitura nero opaco e frontale in Noce canadese. Il top, in cristallo acidato colore Nero, con misure su richiesta, L 225 cm P 54 cm Sp 0,8 cm, ospita i lavabi da appoggio art. FONTE in Marmo Carrara; completa la composizione l'alzatina paraschizzi nella stessa finitura del top.

This composition includes the Neutroled backlit mirror, with measurements on request, L 225 cm H 75 cm, and lamp art. LUCENTINA216, L 216 cm in black painted aluminum; INDIGO taps art. ND921 and art. ND601, matt black finish.

The furniture consists of two sink units art. DIL290 and a cabinet art. DIB245 with structure in Skin cenere, matt black finish frame and front in Noce Canadese.

The top, in black acid-etched glass, with measurements on request, L 225 cm D 54 cm and 0,8 cm thick, houses the countertop sinks art. FONTE in Carrara marble; the composition is completed by a backsplash in the same finish as the top.







Nella foto in alto e a sinistra, variante della composizione precedente con specchi retroilluminati della collezione SPECCHIDICARTA art. SDC11 L 58,9 cm H 85,8, art. SDC12 L 74,3 cm H 74,3 cm; rubinetteria INDIGO art. ND921, art. ND601 finitura grafite. Lavabi da appoggio art. RIGATI60 in marmo Nero Marquinia.

In the photo above and on the left, a variant of the previous composition with backlit mirrors from the SPECCHIDICARTA collection art. SDC11 L 58,9 cm H 85,8, art. SDC12 L 74,3 cm H 74,3 cm; INDIGO taps art. ND921 and art. ND601 graphite finish. Countertop sinks art. RIGATI60 in Nero Marquinia marble.



Questa composizione comprende gli specchi retroilluminati della collezione SPECCHIDICARTA art. SDC10, L 60 cm H 81,8 cm, e art. SDC11, L 58,9 cm H 85,8 cm; rubinetteria INDIGO art. ND921, art. ND601 in finitura nero opaco.

Il mobile è composto da due porta lavabi art. DIL290 e una base art. DIB245 con struttura in Skin cenere, cornice finitura nero opaco e frontale in Noce canadese.

Il top, in cristallo acidato colore Nero, con misure su richiesta, L 225 cm P 54 cm Sp 0,8 cm, ospita i lavabi da appoggio art. SENSOC in Cristalmoood colore Petrolio.

Vasca freestanding art. REFLEX in Cristalmoood colore Petrolio; rubinetteria INDIGO art. ND903 finitura nero opaco.

Tappeto della collezione TRAMATO art. TR655, L 300 cm P 170 cm.



This composition includes the backlit mirrors of the SPECCHIDICARTA collection art. SDC10, L 60 cm H 81,8 cm, and art. SDC11, L 58,9 cm H 85,8 cm; INDIGO taps art. ND921 and art. ND601 in matt black finish. The furniture consists of two sink units art. DIL290 and a cabinet art. DIB245 with structure in Skin cenere, frame with matt black finish and front in Noce Canadese. The top, in black acid-etched glass, with measurements on request, L 225 cm D 54 cm and 0,8 cm thick, houses the countertop sinks art. SENSOC in Cristalmood color Petrolio. Freestanding bathtub art. REFLEX in Cristalmood color Petrolio; INDIGO tap art. ND903 matt black finish. Carpet of the TRAMATO collection art. TR655, L 300 cm D 170 cm.







La composizione è composta da specchi art. COLLAGE353 e art. COLLAGE354, L 54 cm H 75 cm; rubinetteria INDIGO art. ND921, art. ND601, finitura grafite.

Il mobile è formato da due porta lavabi art. DIL290 e una base art. DIB245 con struttura in Skin cenere, cornice finitura nero opaco e frontale in vetro argentato fumè.

Il top in cristallo acidato colore Nero, con misure su richiesta, L 225 cm P 54 cm Sp 0,8 cm, ospita i lavabi da appoggio art. SENSOC in Crismood colore Oleo. Tappeto della collezione GEOMETRIE VOLANTI art. GV642 L 300 cm P 200 cm.



The composition is made up of mirrors art. COLLAGE353 and art. COLLAGE354, L 54 cm H 75 cm; INDIGO taps art. ND921 and art. ND601, graphite finish.

The furniture consists of two sink units art. DIL290 and a cabinet art. DIB245 with structure in Skin cenere, frame with matt black finish and front in fumè mirrored glass.

The black acid-etched glass top, with measurements on request, L 225 cm D 54 cm and 0,8 cm thick, houses the countertop sinks art. SENSOC in Cristalmood color Oleo. Carpet of the collection GEOMETRIE VOLANTI art. GV642 L 300 cm D 200 cm.







La composizione comprende lo specchio art. COLLAGE353, L 54 cm H 75 cm; rubinetteria INDIGO art. ND921, art. ND601 finitura grafite. Il mobile è composto da un porta lavabo art. DIL290, una base art. DIB245 e due basi con vani a giorno art. DIG245, il tutto con struttura in Skin cenere, cornice finitura nero opaco, frontale in vetro argentato fumè. La composizione si completa di illuminazione led optional, interna ed esterna.

Il top in cristallo acidato colore Nero, con misure su richiesta, L 225 cm P 54 cm Sp 0,8 cm, ospita un lavabo da appoggio art. SENSOC in Cristalmood colore Oleo.

Tappeto della collezione GEOMETRIE VOLANTI art. GV645 L 300 cm P 200 cm.

The composition includes the mirror art. COLLAGE353, L 54 cm H 75 cm; INDIGO taps art. ND921 and art. ND601 graphite finish. The furniture consists of a sink unit art. DIL290, a cabinet art. DIB245 and two cabinets with open compartments art. DIG245, all with structure in Skin cenere, frame matt black finish, front in fumè mirrored glass.

The composition is completed with internal and external optional led lighting. The black acid-etched glass top, with measurements on request, L 225 cm D 54 cm and 0,8 cm thick, houses a countertop sink art. SENSOC in Cristalmood color Oleo.

Carpet of the collection GEOMETRIE VOLANTI art. GV645 L 300 cm D 200 cm.



BEMADE LEGENDA - KEY

La struttura e i fianchi di serie sono in finitura Skin cenere, su richiesta è possibile personalizzare i fianchi esterni in finitura laccata o in essenza legno.

The structure and the side panels are in skin cenere, upon request you can personalize the external side panels lacquered or veneered.

FIANCO DI SERIE | STANDARD SIDE

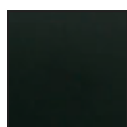

Skin cenere

FIANCO PERSONALIZZATO VERNICIATO O IN ESSENZA LEGNO | PERSONALIZED SIDE LACQUERED OR VENEERED



Verniciato opaco, goffrato, lucido o finitura seta come da nostro campionario colori.

Lacquered matt, embossed, glossy or silk finish as per our color samples.

art.

DF1

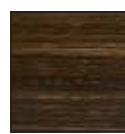

Rovere:
sbiancato, naturale castano, moro,
grigio, matita, ardesia, thermo.

Noce:
canadese, visone, canaletto.

Essenza legno

Wood essence

art.

DL1

BEMADE LEGENDA - KEY

Per calcolare il prezzo di un elemento è necessario scegliere la finitura dei frontali identificata dal numero **1 e 2** e la finitura della cornice **5 o 6**.

To calculate the price of an element it is necessary to select the finish of the front(s) identified by the numbers **1 and 2**, and the finish of the frame **5 or 6**.

FINITURE FRONTALI | FRONT FINISH **1 | 2**

FINITURE CORNICI | FRAME FINISH **5 | 6**



1



Vetro trasparente bronzo
Transparent bronze glass

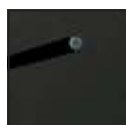

Vetro trasparente fumé
Transparent fumé glass



Vetro argentato naturale
Natural mirrored glass



Vetro argentato bronzo
Bronze mirrored glass



Vetro argentato fumé
Fumé mirrored glass



Vetro cannettato trasparente
Ribbed clear glass

2



Vetro riflettente fumé
Reflective fumé glass

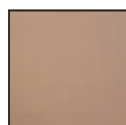

Vetro acidato bronzo
Bronze acid glass



Vetro acidato fumé
Fumé acid glass



Rovere:
sbiancato, naturale castano,
moro, grigio, matita, ardesia,
thermo.
Noce:
canadese, visone, canaletto.



Vetro acidato laccato come da
nostro campionario colori.
*Acid glass lacquered as per our
color samples.*

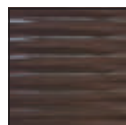

Vetro cannettato laccato come
da nostro campionario colori.
*Ribbed glass lacquered as per
our color samples.*

5



Bronzo



Titanio



Zirconio



Champagne



Bianco opaco
Matt white



Nero opaco
Matt black

6



Cornice verniciata gofrata come
da nostro campionario colori.
*Frame lacquered in an embossed
finish as per our sample colors.*

BEMADE COMPONENTI - COMPONENTS

PORTA LAVABI | SINK UNITS

Porta lavabo con 1 cassetto Art. SLIM sagomato internamente per sifone.

Sink unit with 1 drawer Art. SLIM internally shaped for siphon.

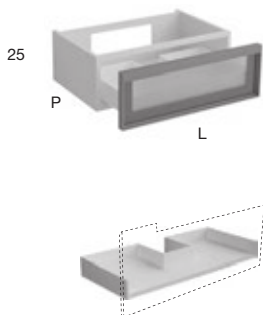

H	P	L
25	40	54 - 63 - 72 - 90 - 108
	47	
	54	

Porta lavabo con 2 cassetti Art. SLIM di cui 1 sagomato internamente per sifone.

Sink unit with 2 drawers Art. SLIM of which 1 internally shaped for siphon.

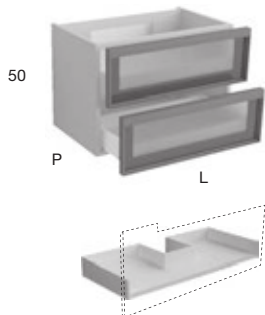

H	P	L
50	40	54 - 63 - 72 - 90 - 108
	47	
	54	

Porta lavabo con 1 cassetto Art. SLIM.
Large drawer sink unit Art. SLIM.

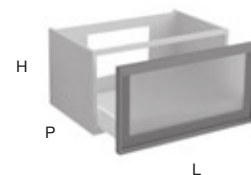

H	P	L
37,5	40	54 - 63 - 72 - 90 - 108
	47	
	54	

BASI | CABINETS

Base con 1 cassetto Art. SLIM.
Single drawer cabinet Art. SLIM.

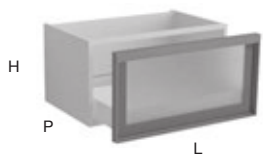

H	P	L
25	40	36 - 45 - 54 - 63 - 72 - 90 - 108
	47	
	54	

Base con 2 cassetti Art. SLIM.
Cabinet with 2 drawers Art. SLIM.

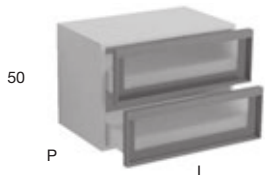

H	P	L
50	40	36 - 45 - 54 - 63 - 72 - 90 - 108
	47	
	54	

Base con 1 vano a giorno.
Open cabinet with 1 compartment.

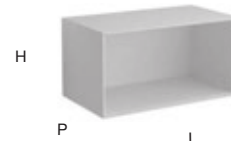

H	P	L
25	40	27 - 36 - 45 - 54 - 63 - 72 - 90
	47	
	54	

PENSILI | WALL CABINETS

Pensile dx o sx con 1 anta.
Right or left single door wall cabinet with 1 internal shelf.

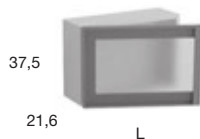

H	P	L
37,5	21,6	36 - 45

Pensile dx o sx con 1 anta e 1 ripiano interno.
Right or left single door wall cabinet with 1 internal shelf.

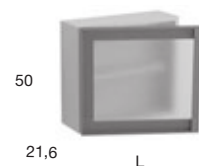

H	P	L
50	21,6	36 - 45 - 54

Pensile dx o sx con 1 anta e 2 ripiani interni.
Right or left single door wall cabinet with 2 internal shelves.

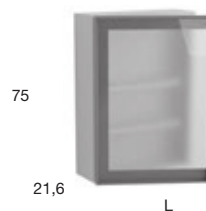

H	P	L
75	21,6	36 - 45 - 54

Pensile dx o sx con 1 anta e 3 ripiani interni.
Right or left single door wall cabinet with 3 internal shelves.

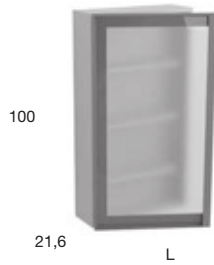

H P L
 100 21,6 36 - 45 - 54

Pensile con 2 ante.
Double door wall cabinet.

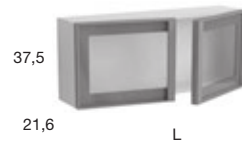

H P L
 37,5 21,6 72 - 90

Pensile con 2 ante e 1 ripiano interno.
Double door wall cabinet with 1 internal shelf.

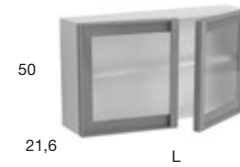

H P L
 50 21,6 72 - 90 - 108

Pensile con 2 ante e 2 ripiani interni.
Double door wall cabinet with 2 internal shelves.



H P L
 75 21,6 72 - 90 - 108

Pensile con 2 ante e 3 ripiani interni.
Double door wall cabinet with 3 internal shelves.

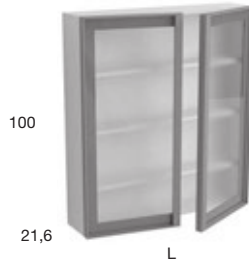

H P L
 100 21,6 72 - 90 - 108

Pensile a giorno.
Open wall cabinet.



H P L
 25 14 27 - 36 - 45 - 54 - 72 - 90
 37,5 21,6

Colonna dx o sx con 1 anta e 3 ripiani interni.
Right or left single door high cabinet with 3 internal shelves.



H P L
 125 21,6 36 - 45 - 54
 33,6
 47

Colonna dx o sx con 1 anta e 4 ripiani interni.
Right or left single door high cabinet with 4 internal shelves.



H P L
 150 21,6 36 - 45 - 54
 33,6
 47

Colonna dx o sx con 1 anta e 5 ripiani interni.
Right or left single door high cabinet with 5 internal shelves.



H P L
 175 21,6 36 - 45 - 54
 33,6
 47

PENSILI | WALL CABINETS ▽

PENSILI | WALL CABINETS ▽

COLONNE | HIGH CABINETS ▽

BEMADE COMPONENTI - COMPONENTS

COLONNE | HIGH CABINETS ▽

Colonna dx o sx con 1 ante e 6 ripiani interni completa di piedini regolabili.

Right or left single door high cabinet with 6 internal shelves and regulating feet.



H	P	L
210	21,6	36 - 45 - 54
		33,6
		47

Colonna con 2 ante e 3 ripiani interni.

Double door high cabinet with 3 internal shelves.



H	P	L
125	21,6	72 - 90 - 108
		33,6
		47

Colonna con 2 ante e 4 ripiani interni.

Double door high cabinet with 4 internal shelves.



H	P	L
150	21,6	72 - 90 - 108
		33,6
		47

COLONNE | HIGH CABINETS ▽

Colonna con 2 ante e 5 ripiani interni.

Double door high cabinet with 5 internal shelves.



H	P	L
175	21,6	72 - 90 - 108
		33,6
		47

Colonna con 2 ante e 6 ripiani interni completa di piedini regolabili.

Double door high cabinet with 6 internal shelves complete with regulating feet.



H	P	L
210	21,6	72
		33,6
		47

COLONNE | HIGH CABINETS ▽

Colonna a giorno con 3 ripiani.

Open high cabinet with 3 compartments.



H	P	L
125	21,6	18 - 27 - 36 - 45
		33,6

Colonna a giorno con 4 ripiani.

Open high cabinet with 4 compartments.



H	P	L
150	21,6	18 - 27 - 36 - 45
		33,6

Colonna a giorno con 5 ripiani.

Open high cabinet with 5 compartments.



H	P	L
175	21,6	18 - 27 - 36 - 45
		33,6



BESPOKE

2016

design_Carlo Colombo

Essenziale ma materica, versatile ma elegante, borghese ma contemporanea. Una collezione pensata per l'ambiente bagno ma che ridefinisce i canoni dell'arredo anche nell'area living.

Dettagli tecnologici e formali importanti, elementi funzionali ed estetici che concorrono alla definizione di uno stile.

Dalle ante ai piani, dalle maniglie alle cerniere, ogni componente del progetto è pensato per dar vita a un'estetica fatta di dettagli unici e di un perfetto equilibrio compositivo generato da proporzioni perfette, superfici pulite e finiture inedite. Tutto questo è Bespoke, è un sistema d'arredo che porta un messaggio di stile ed eleganza nell'ambiente bagno ma non solo, è un progetto che trasmette allo spazio e a chi lo vive il gusto del bello.

Profili in alluminio satinato e ante in vetro 4mm, disponibili entrambi in diverse finiture, contenitori in essenze ricercate.

Ogni materia è espressa nella propria essenza, ogni texture porta valore aggiunto all'insieme, ogni configurazione esprime al meglio la profondità del progetto. Una pluralità di materie che parlano lo stesso linguaggio, accostamenti raffinati che instaurano un dialogo virtuoso tra tutte le superfici.

Basi, porta lavabi, pensili o colonne che possono raggiungere l'altezza massima di 210 cm.

Un sistema modulare e versatile che assicura la massima libertà compositiva per dar vita a mobili e contenitori attrezzabili anche con cassette.

Ogni configurazione esprime la capacità di Bespoke di diventare sistema, racconta l'attenzione di antoniolupi nel tradurre l'idea in un progetto organico ed esclusivo, sottolinea la qualità delle lavorazioni e la visione dell'azienda finalizzata a definire uno spazio sartoriale e personalizzato.

Essential, versatile and elegant, bourgeois yet contemporary.

A collection thought for the bathroom but that can easily redefine the living area. Technological and important details, functional and aesthetical elements that define a style.

From the fronts to the surfaces and from the handles to the hinges each component of the project is designed to create unique details and a perfect balance of the composition.

All of this is Bespoke, a furniture system which brings a message of elegance into the bathroom as well as a project that conveys to space and to those who experience taste for beauty.

Brushed aluminum frames and fronts in 4 mm glass, both available in various finishes ; containers in prized essences.

Each material is expressed in its essence and each texture adds value to the composition.

A plurality of materials that speak the same language refined combinations that establish a virtuous dialogue between all surfaces.

Cabinets, sink units, hanging cabinets that can reach a height of 210 cm. A modular and versatile system that ensures maximum freedom in creating compositions.

Each configuration expresses the ability to become a system and shows the attention of the company in translating the idea of an exclusive project into a tailored and personalized space.











Questa composizione comprende lo specchio retroilluminato art. SUPERLUNA108W Ø 108 cm; rubinetteria INDIGO art. ND921 e art. ND601 finitura cromo lucido. Il mobile è composto da una base art. KIB236, una base art. KIB2108, una base art. KIB272 struttura Rovere thermo, cornice finitura Zirconio, frontale in vetro acidato bronzo. Il top in Colormood Basalto, art. BC154 L 216 cm P 54 cm Sp 1,2 cm completa le basi, mentre il top scatolato, art. BCS54 L 216 cm P 54 cm H 12,5 cm, ospita il lavabo integrato art. PODIO90. A parete colonna con struttura Rovere thermo, cornice finitura Zirconio, frontale in vetro acidato bronzo, art. KC3790. La composizione si completa di optional: illuminazione a led interna ed esterna, attrezzatura interna per cassetti DOMINO ed i vasi art. NISI1 e art. NISI2 in Cristalmood Fumè. Carta da parati TRALERIGHE, art. Q10N e art. O10N. Tappeto della collezione TRAMATO art. TR654 L 234 cm P 218 cm.

This composition includes a backlit mirror art. SUPERLUNA108W Ø 108 cm; INDIGO taps art. ND921 and art. ND601 in polished chrome. The furniture is made up of cabinets art. KIB236 and art. KIB272 in Rovere thermo, frame in zirconium and front in acid etched bronze glass. The top is in Colormood Basalto, art. BC154 L 216 cm D 54 cm and 1,2 cm thick that complete the cabinets. The boxy top is art. BCS54 L 216 cm D 54 cm and 1,2 cm H 12,5 cm houses the integrated sink art. PODIO90. The high cabinet art. in Rovere thermo frame in zirconium, front in acid etched bronze glass art. KC3790. The composition is complete with optional: internal and external led lighting and drawer accessories DOMINO. Vases art. NISI1 and art. NISI2 in Cristalmood Fumè. Wallpaper TRALERIGHE art. Q10N and art. Q10N. carpet from the TRAMATO collection art. TR654 L 234 cm D 218 cm.





BESPOKE



La composizione comprende due specchi art. VARIO50W con interruttore art. MAGIC, una coppia di lampade a led art. BOLLA2, rubinetteria BIKAPPA art. BK200N.

Il mobile è composto da un top in Flumood Falena con lavabo integrato art. NIDO72, da una struttura in Rovere thermo con cornici finitura Bronzo.

Il frontale dei cassetti è in vetro argentato colore bronzo.



The composition has two mirrors art. VARIO50W with switch art. MAGIC, a pair of led lamps art. BOLLA2, BIKAPPA taps art. BK200N. The furniture combination has a Flumood top in Falena with integrated sink art. NIDO72, the carcass in Rovere thermo while the frame is in bronze aluminum. The fronts of the drawers are in bronze mirrored glass.



Cassetto interno opzionale art. SLIM54 e attrezzature STRATO con divisori in vetro fumè.

Internal optional drawer art. SLIM54 and accessories STRATO with dividers in fumè glass.



BESPOKE



Nella foto due composizioni, una di L 216 cm ed una di L 180 cm, H 37,5 cm P 54 cm. Il mobile di larghezza L 216 cm, è composto da due basi art. KIB272 e da un porta lavabo art. KIL272.

Il top è in Flumood Bianco art. BC154, con lavabo integrato art. NIDO72, L 216 cm P 54 cm.

La seconda composizione è formata da una base di L 90 cm, art. KIB290 e da un porta lavabo L 90 cm, art. KIL290. Il top è in Flumood Bianco art. BC154, con lavabo integrato art. NIDO72, L 180 cm, P 54 cm. La struttura è in essenza Noce canaletto, la cornice in finitura Titanio e il vetro argentato fumé. Gli specchi sono della collezione BESPOKE con cornice finitura Titanio, art. BSK50W di L 216 cm e H 50 cm e art. BSK50W di L 180 cm e H 50 cm; sopra di essi le lampade art. BOLLA2.

La rubinetteria è della collezione BIKAPPA, art. BK200N. All'interno dei cassetti, le attrezzature STRATO, art. SRC5490, per il cassetto di larghezza 90 cm e art. SRC5472, per il cassetto di larghezza 72 cm.



*In the picture, two compositions, one measuring L 216 cm and one measuring L 180 cm, H 37,5 cm D 54 cm. Furniture measuring L 216 cm is made up of two cabinets art. KIB272 and one sink unit art. KIL272.
 The top in white Flumood art. BC154 with integrated sink art. NIDO72, L 216 cm D 54 cm.
 The second composition is made up of a cabinet L 90 cm, art. KIB290 and a sink unit L 90 cm, art. KIL290.
 The top in white Flumood art. BC154 with integrated sink model NIDO72 L 180 cm, P 54 cm.
 The structure is In wood essence Noce canaletto, frame in titanium and mirrored fumè glass.
 The mirrors are from the BESPOKE collection art. BSK50W di L 216 cm, H 50 cm and art. BSK50W di L 180 cm, H 50 cm with frames in aluminum titanium finish; lamps art. BOLLA2. BIKAPPA tap series art. BK200N.
 Inside the drawers STRATO accessories art. SRC5490 for the drawer measuring 90 cm and art. SRC5472 for the drawer 72 cm wide.*



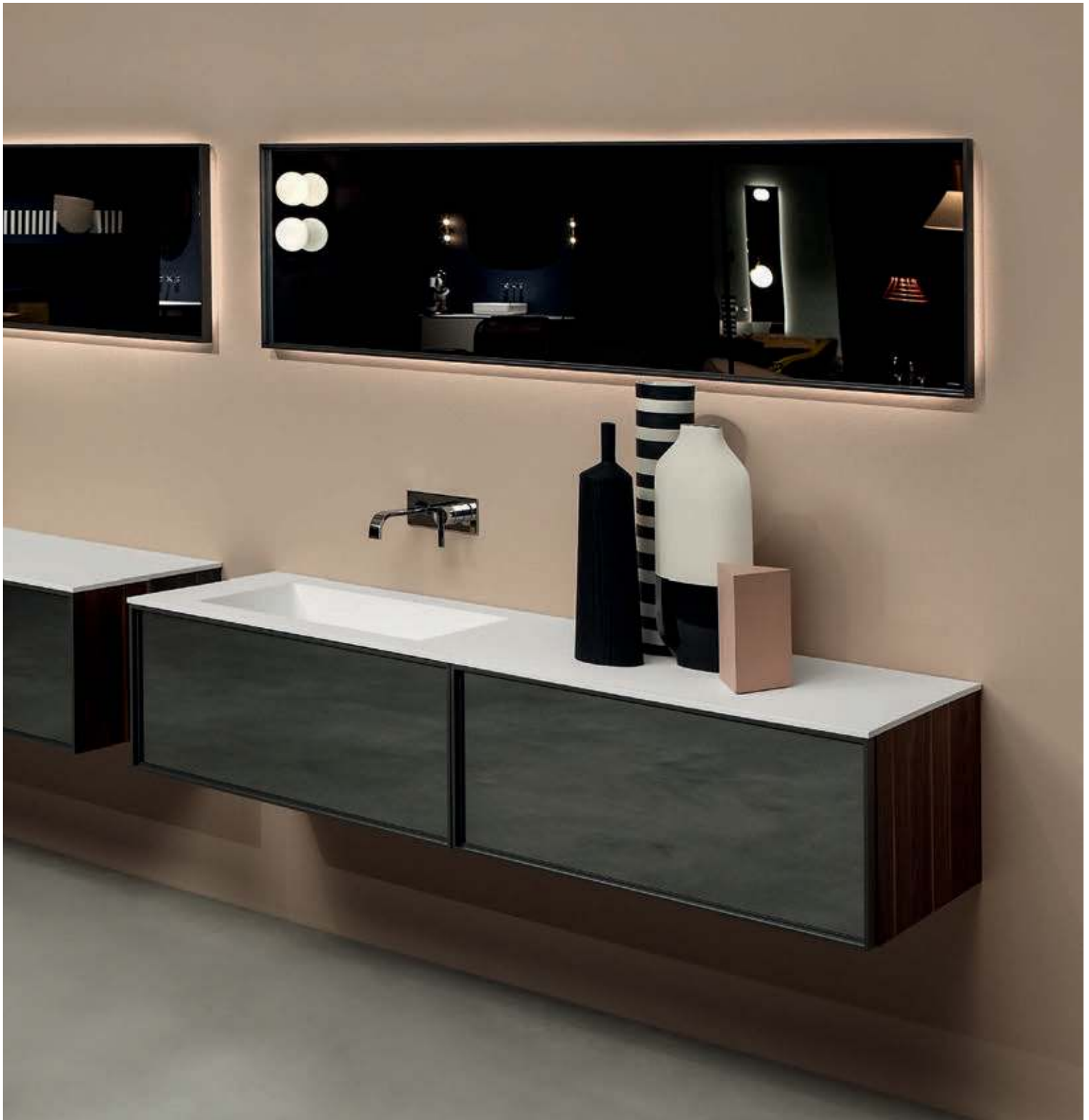

A sinistra attrezzature STRATO con divisori in vetro fumè.
On the left accessories STRATO with dividers in fumè glass.





BESPOKE

La composizione comprende a sinistra una colonna art. KC3472, struttura Rovere thermo con cornice in finitura Bronzo, ante in vetro argentato bronzo. Specchio art. BSK50W sul quale è stata inserita una coppia di lampade art. BOLLA2 con profili in alluminio finitura Bronzo. Sotto lo specchio una mensola da incasso a parete con struttura in alluminio nero con illuminazione a led, art. OMBRAL di L 90 cm con portasalviette art. OMBRAP36. Il mobile è composto da una base portalavabo art. KIL290 e da una base art. KIB290 entrambe con struttura Rovere thermo con cornice in finitura Bronzo, ante in vetro argentato bronzo. Il lavabo in Flumood Bianco è l'art. SENSO, mentre la rubinetteria della serie AYATI è in finitura satinata art. AY921SA e art. A600SA. Il top è in marmo Emperador, art. MR154.

The composition is made up of a column on the left at. KC3472, structure in Rovere thermo and frame in bronze aluminum finish, fronts in bronze silvered glass. Mirror art. BSK50W and pair of lamps art. BOLLA2 with a bronze aluminum frame. Under the mirror is an encased shelf with a black aluminum frame and led lighting, art. OMBRAL L 90 cm and towel bar art. OMBRAP36.

The composition is made up of a sink unit art. KIL290 and a cabinet art. KIB290 both with structure in Rovere thermo and frame in bronze aluminum, fronts in bronze silvered glass. The sink in white Flumood is art. SENSO while the tap is from the AYATI series in satin stainless steel art. AY921SA and art. A600SA. The top is in Emperador marble art. MR154.



In questa composizione in alto sono posizionati due specchi art. VARIO50W con illuminazione a led più coppia di lampade art. BOLLA2. Sotto troviamo una mensola da incasso a parete con struttura in alluminio nero con illuminazione a led, art. OMBRAL di L 108 cm con portasalviette art. OMBRAP36. Il mobile è composto da una base portalavabo art. KIL290 e da una base art. KIB290 entrambe con struttura Skin cenere e cornici in finitura Titanio, ante in vetro argentato fumé. Il top in Flumood Bianco con lavabo integrato art. NIDO72 mentre la rubinetteria della serie AYATI è in acciaio satinato art. AY921SA e art. AY600SA. I sanitari sono art. KOMODO3 e art. KOMODO4 con rubinetteria AYATI art. AY400SA. Sopra e a lato dei sanitari sono posizionati una placca art. ONDA in acciaio satinato e un idroscopino con porta carta art. CARTATENSO sempre in acciaio satinato.



In the composition above are positioned two mirrors art. VARIO50W with led lighting and pair of lamps art. BOLLA2. Below an encased frame with structure in black aluminum and led lighting art. OMBRAL with towel rail art. OMBRAP36. The cabinet is made up of a sink unit art. KIL290 and of a cabinet art. KIB290 both with structure in Skin cenere and frame in aluminum with a titanium finish, fronts in smoked silvered glass. The top is in white Flumood with integrated basin art. NIDO72 while the tap series is AYATI in satin stainless steel art. AY921SA and art. AY600SA.

The sanitary-ware is art. KOMODO3 and art. KOMODO4 with AYATI tap art. AY400SA. Above and next to the sanitary-ware are the flush plate in satin stainless steel art. ONDA and a hydrobrush with paper roll holder art. CARTATENSO in satin stainless steel.







La composizione nella foto a destra comprende due specchi NEUTROLED e due specchi NEUTROKIT. Gli specchi NEUTROKIT sono predisposti uno per l'inserimento di rubinetteria AYATI art. AY921LU e art. AY600LU, l'altro per l'inserimento del portasalviette art. RETTA472 colore Malta goffrato. Il mobile è composto da due basi porta lavabo art. KILM290 e altre due basi art. KIBM290, colore Grigio smog opaco, la cornice è in finitura Titanio, il frontale dei cassetti è in vetro acidato fumé. Il top, art. MR147, è in marmo Emperador. I due lavabi da appoggio sono art. SENSO.

Nella foto sopra, particolare di un cassetto con attrezzatura interna DOMINO finitura Noce canaletto.

The composition in the picture on the right has two mirrors NEUTROLED and two mirrors NEUTROKIT. The mirrors NEUTROKIT are prepared for the tap series AYATI art. AY921LU and art. AY600LU, as well as prepared for the towel bar art. RETTA472 in color embossed Malta. The furniture is made up of two sink units art. KILM290 and two cabinets art. KIBM290 in color matt Grigio smog. The frame is aluminum with a titanium finish, the fronts are in acid etched smoked glass. The top is in Emperador marble. The two top mount sinks are art. SENSO

In the picture above is the detail of the drawer with internal accessories DOMINO in Noce canaletto finish.



BESPOKE





La composizione a sinistra comprende due specchi NEUTROKIT e due specchi NEUTROLED, rubinetteria AYATI art. AY921LU e art. AY600LU, e un portasalviette art. RETTA472 colore Malta goffrato. Il mobile è composto da due basi porta lavabo art. KILM290 e altre due basi art. KIBM290 di colore Grigio smog opaco, da un top in Flumood Serena, art. BC147 con due lavabi in Flumood Bianco art. VERSO e cornici finitura Titanio. I frontali dei cassetti sono in vetro acidato Malta, l'attrezzatura è collezione STRATO con divisori in vetro fumé.

The composition on the left has two mirrors NEUTROKIT and two mirrors NEUTROLED, AYATI taps art. AY921LU and Art. AY600LU and a towel rail art. RETTA472 embossed lacquered Malta. The furniture is made up of two sink units art. KALM290 and two cabinets art. KIBM290 matt Grigio smog, has a Flumood top color Serena art. BC147 and two top mount sinks in white Flumood art. VERSO, while the frames are aluminum titanium.

The drawer fronts are in acid glass color Malta. Accessories STRATO with dividers in fumé glass.



Nelle foto: vasca da bagno in Cristalplant art. BAÍAS con rubinetteria AYATI art. AY903LU e camino art. CANTOMC63 con bruciatore art. LAFLACA. Nella foto a destra sanitari sospesi art. KOMODO3 e art. KOMODO4 in ceramica satinata con rubinetteria AYATI art. AY400LU.

In the photo: Cristalplant bathtub art. BAÍAS with AYATI tap art. AY903LU and fireplace art. CANTOMC63 with burner art. LAFLACA. In the picture on the right, suspended sanitary-ware art. KOMODO3 and art. KOMODO4 both in satin glaze ceramic with AYATI tap art. AY400LU.



I quattro pensili, art. KE3490, hanno la struttura color Matita goffrato mentre le cornici sono in finitura Bronzo. Le ante sono in vetro argentato fumé.

The four wall cabinets, art. KE3490 have the carcass lacquered embossed Matita while the frames are in bronzed aluminum. The fronts are in silvered fumé glass.



La composizione nella foto comprende uno specchio art. FLASH100W, una coppia di lampade a led art. BOLLA2, rubinetteria BIKAPPA art. BK200N, due barre porta asciugamani art. RETTA490 colore Ovatta goffrato, un termoarredo art. BITL180E colore Ovatta goffrato. Il mobile è composto da un top con lavabo integrato in Flumood Bianco, art. NIDO72, la struttura e i cassetti sono color Ovatta opaco mentre le cornici sono in finitura Bronzo. Le ante sono in vetro acidato colore Ovatta.

I due pensili esterni hanno la struttura color Ovatta opaco mentre le cornici sono in finitura Bronzo con le ante in vetro Ovatta acidato. Il pensile centrale ha l'anta in vetro trasparente fumé.



The composition in the photo has a mirror art. FLASH100W, a pair of led lamps art. BOLLA2, tap series BIKAPPA, art. BK200N, two towel rails art. RETTA490 lacquered embossed Ovatta, a radiator art. BITL180E lacquered embossed Ovatta. The cabinet has a white Flumood top with integrated sink art. NIDO72, the carcass lacquered matt Ovatta while the frame in bronze aluminum. Fronts and drawers are in acid glass colour Ovatta. The two external wall cabinets are in structure Ovatta matt, frame bronze and front in lacquered acid glass Ovatta, while the wall cabinet in the center has the front in transparent fumè glass.





La composizione è formata da una base porta lavabo con ante art. KIL5490, una base con doppio cassetto art. KIB472 Ovatta opaco e una base con anta art. KIB5245. La struttura è Ovatta opaco, le cornici sono in finitura Champagne, gli altri frontali sono in vetro acidato bronzo. Il top in Flumood Bianco L 207 cm, P 54 cm, spessore 1,2 cm, art. BC154, ospita il lavabo integrato art. NIDO54. Rubinetteria BIKAPPA art. BK200N. Lo specchio art. FLASH100W L 162 cm H 100 cm, è abbinato alla coppia di lampade art. BOLLA2. I 3 pensili art. KE2045 L 45 cm, H 100 cm e P 21,6 cm ciascuno, hanno struttura Ovatta opaco, cornici in finitura Champagne; due frontali sono in vetro acidato Ovatta e uno in vetro acidato bronzo. A destra due portasalviette art. RETTA490 Ovatta goffrato L 90 cm ciascuna.

The composition is made up of a sink unit with doors art. KIL5490, a cabinet with two double drawers art. KIB472 in color matt Ovatta and a cabinet with door art. KIB5245. The structure is matt Ovatta, the frame in aluminum Champagne finish, the fronts in bronze acid etched glass. The top is in white Flumood L. 207 cm, D. 54 cm, 12 mm thick, art. BC154 with integrated sink model NIDO54. Tap series BIKAPPA art. BK200N. The mirror is art. FLASH100W L 162 cm H 100 cm combined with the pair of lamps art. BOLLA2. The 3 wall cabinets art. KE2045 L 45 cm, H 100 cm and D 21,6 cm each, with a matt Ovatta color structure, frame in aluminum Champagne finish; two fronts in acid etched glass color Ovatta and one in bronze acid etched glass. On the right two towel bars art. RETTA490 lacquered embossed Ovatta L. 90 each.





I due pensili, art. KE2045, hanno la struttura color Malta opaco, cornici finitura Bronzo e ante in vetro acidato colore Cortecchia.
The two wall cabinets, art. KE2045 with carcass lacquered matt Malta, frame in Bronze aluminum and fronts in acid glass color Cortecchia.





La composizione nelle foto comprende due specchi art. NTKIT50W e art. NEUTROLED100W, rubinetteria AYATI art. AY921SA e art. AY600SA, due pensili con struttura color Malta opaco, cornice finitura Bronzo e ante in vetro acidato colore Cortecchia. Il mobile è composto da un top in Flumood Falena, art. BC154 con due lavabi in Flumood Bianco art. SENSO, la struttura è color Malta opaco mentre le cornici sono in finitura Bronzo. I due porta lavabi art. KIL290 e la base art. KIB290, sono in vetro acidato colore Cortecchia corredati da attrezzatura STRATO con divisori in vetro fumé.

The composition in the photo has two mirrors art. NTKIT50W and art. NEUTROLED100W, taps AYATI art. AY921SA and art. AY600SA, two wall cabinets with carcass lacquered matt Malta, frame in Bronze aluminum and fronts in acid glass color Cortecchia. The cabinet has a Flumood top Falena art. BC154 with two sinks in white Flumood art. SENSO, the two sink units art. KIL290 and cabinet art. KIB290, is lacquered matt Malta while the frames are in Bronze aluminum. The drawer fronts are in acid glass color Cortecchia complete with internal accessories STRATO with glass dividers color fumé.



Lo specchio L 180 cm, H 90 cm, art. VARIO90W, con interruttore art. MAGIC, è corredato da lampade art. BOLLA2. Il mobile, L 180 cm, H 37,5 cm, P 47 cm, è composto da una base con cassetto e da un porta lavabo entrambi di L 90 cm; cornici finitura Titanio, i vetri Creta acidato e la struttura Creta gofrata. Sopra poggiano il top in vetro acidato Creta art. 947 e il lavabo in Flumood Bianco art. SENSO. La rubinetteria è AYATI in finitura satinata art. AY200SA.

The mirror L 180 cm, H 90 cm art. VARIO90W with switch art. MAGIC and illuminated by the lamp art. BOLLA2. The cabinet L 180 cm H 37,5 cm D 47 cm is made up of a cabinet with single drawer and sink unit L 90 cm; the profiles are in titanium the acid glass lacquered Creta and the carcass lacquered embossed Creta. The top is in acid glass lacquered Creta art. 947 and the sink is in white Flumood art. SENSO. AYATI tap art. AY200SA in the satin finish.



BESPOKE







Questa composizione comprende lo specchio art. COLLAGE356, L 72 cm H 100 cm, rubinetteria INDIGO art. ND301 finitura acciaio satinato. Il mobile è composto da due porta lavabi art. KIL290 e una base art. KIB290, struttura Skin cenere, finachi personalizzati in Rovere grigio, cornice finitura Champagne, frontale in vetro acidato fumè. Il top in Flumood Bianco art. BC154, nella misura L 270 cm P 54 cm Sp 1,2 cm, ospita i lavabi integrati art. NUVOLA prof. 54 cm. Due colonne a giorno art. ICE3 in vetro trasparente fumè e schienale Rana blu goffrato. Termoarredo BITLIGHT art. BITL190E verniciato goffrato Rana blu. Tappeto della collezione GEOMETRIE VOLANTI art. GV641 L 300 cm P 200 cm. Vasca art. BAIAS, rubinetteria INDIGO art. ND903 finitura acciaio satinato.

This composition is made of the COLLAGE356 mirrors L 72 cm H 100 cm, INDIGO tap series art. ND301 satin steel finish. The furniture is made up of ink unit art. KIL290 and a cabinet with structure in Skin cenere, side panels personalized Rovere grigio, frame Champagne, fronts in fume acid etched glass.

The top is white Flumood art. BC154 L 270 cm D 54 cm and 1,2 cm thick houses the integrated basins art. NUVOLA 54 cm deep. Two open wall cabinets art. ICE3 in fume glass and back lacquered embossed Rana blu. Radiator BITLIGHT art. BITL190E embossed lacquered Rana blu. Carpet from the GEOMETRIE VOLANTI art. GV641 L 300 cm D 200 cm. Bath tub art. BAIAS, INDIGO tap art. ND903 in satin steel finish.



Nella foto in alto, cinque colonne art. KC1745 con struttura Skin cenere, cornice finitura Champagne; due frontali sono in vetro riflettente fumè, gli altri in vetro acidato fumè.

In the picture above five high cabinets art. KC1745 with structure in Skin cenere, champagne frame; two fronts are in reflective fume glass and the others in acid etched fume.





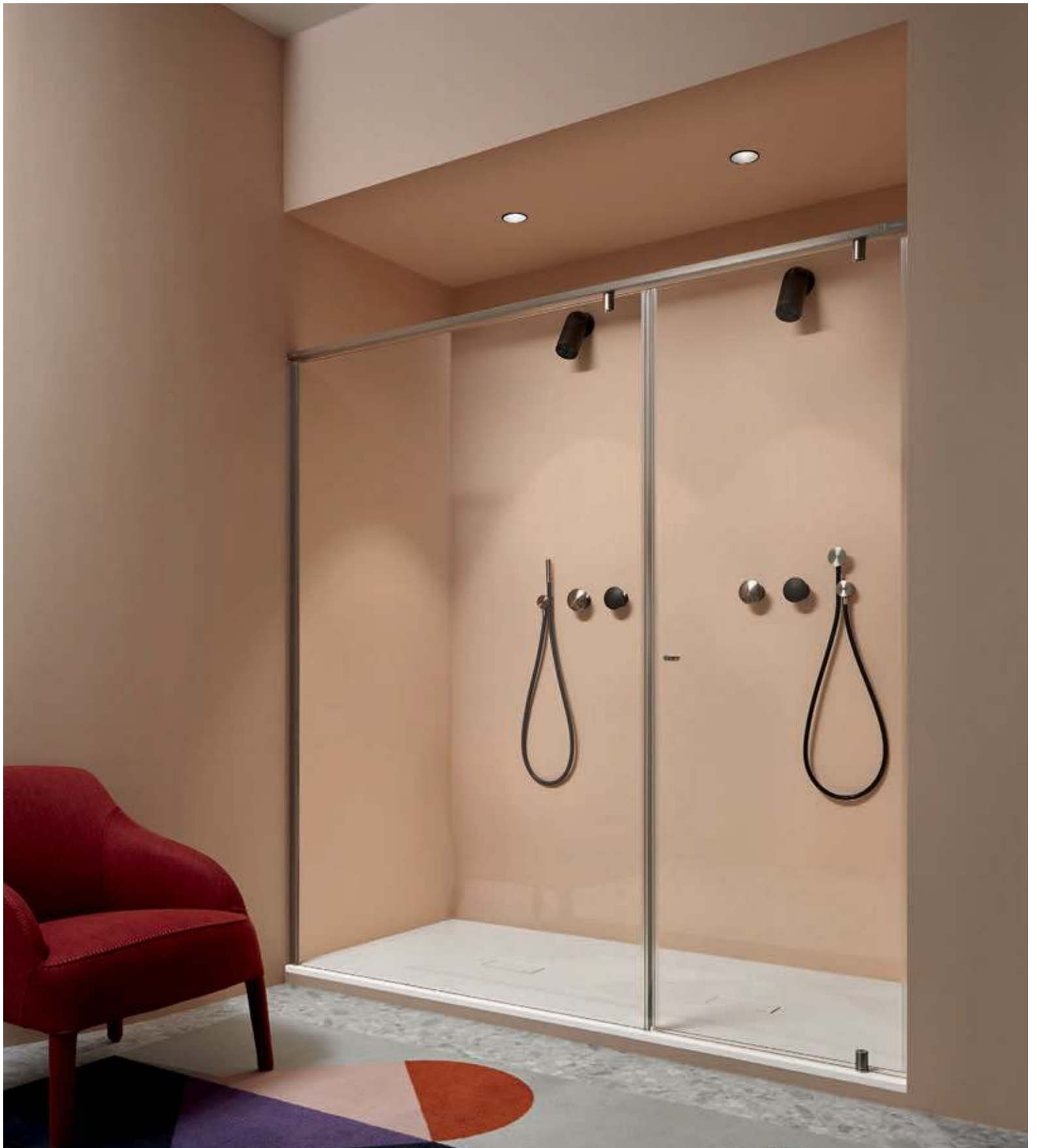

Nella foto in alto, box doccia art. BILICO3N versione destra in vetro extrachiaro, H 198,3 cm completo di profili, perno e barra di sostegno in acciaio inox satinato. Piatto doccia SUMISURA in Moodlight art. SM_90, L 200 cm P 90 cm, con doppio scarico. Rubinetteria MAYDAY: due art. MAYDAYD, deviatore in acciaio satinato e due art. MAYDAY, miscelatore in finitura grafite. A sinistra doccetta art. FILO e a destra doccetta art. FILTRO, entrambe in acciaio inox satinato e flessibile in silicone nero. A parete due soffioni art. AZIMUTVO verniciati nero opaco. A soffitto, i due faretti sono due art. ZENITLED.

In the photo above, shower enclosure art. BILICO3N right version in extra-clear glass, H 198.3 cm complete with profile, pin and support bar in satin stainless steel. SUMISURA shower tray in Moodlight art. SM_90, L 200 cm D 90 cm, with double drain. MAYDAY taps: two art. MAYDAYD, satin steel diverter and two art. MAYDAY, mixer in graphite finish. On the left, hand shower art. FILO and on the right, hand shower art. FILTRO, both in satin stainless steel with flexible hose in black silicone. Two showerheads on the wall art. AZIMUTVO lacquered matt black. On the ceiling, the two spotlights are art. ZENITLED.



BESPOKE



In questa composizione il mobile è composto da un porta lavabo art. KIL290 e due basi art. KIB245, struttura in Skin cenere, fianchi personalizzati in Rovere thermo, cornice finitura Titanio, frontale in vetro riflettente fumè. I tre pensili, art. KE3790, hanno la struttura in Skin cenere, cornice finitura Titanio; due frontali sono in vetro trasparente fumè, gli altri in vetro argentato fumè. Il mobile è completato dall'attrezzatura interna DOMINO.

Il top in Flumood Bianco art. BC154, nella misura L 180 cm P 54 cm Sp 1,2 cm, ospita il lavabo integrato art. BRECCIA. Rubinetteria INDIGO art. ND301 finitura grafite. Portasalviette art. PLAY72 finitura Titanio e pianetto in Corian art. TAPE11.

Tappeto della collezione GEOMETRIE VOLANTI art. GV55 L 400 cm P 100 cm.

This composition is made up of a sink unit art. KIL290 and two cabinets art. KIB245, structure in Skin cenere and sides personalized in Rovere thermo, frame in aluminum titanium front in reflective fumè glass. The three wall cabinets art. KE3790 have the structure in Skin cenere, frame in titanium; two fronts are in clear fumè glass, the others in mirrored fumè glass. The cabinet is complete with internal accessories DOMINO. The top in white Flumood art. BS154 in the measurement L 180 cm D 54 cm and 1,2 cm thick houses the integrated sink art. BRECCIA. INDIGO tap art. ND301 in the graphite finish. Towel rail art. PLAY72 in the titanium finish and Corian surface art. TAPE11. Carpet from the GEOMETRIE VOLANTI collection art. GV55 L 400 cm D 100 cm.





Vetro riflettente fumé

Reflective fumé glass

La composizione è formata da un porta lavabo art. KIL2108 e due basi art. KIB254, struttura Rovere thermo, cornice finitura Zirconio, frontale in vetro riflettente fumé. Il top in Flumood Bianco art. BC154, nella misura L 216 cm P 54 cm Sp 1,2 cm, ospita il lavabo integrato art. PODIO108 completo di pianetto copripiletta art. PIANETTO. Rubinetteria BIKAPPA art. BK400N finitura cromo lucido. Lo specchio con illuminazione a led, art. CIRCUS140W, è Ø 140 cm.

The composition is made up of a sink unit KIL2108 and two cabinets art. KIB254 with structure in Rovere thermo frame zirconium and front in reflective fume glass. White Flumood top art. BC154 L 216 cm D 54 cm 1,2 cm thick houses integrated sink art. PODIO108 complete with cover art. PIANETTO. BIKAPPA tap series art. BK400 in polished chrome. The mirror with led lighting art. CIRCUS140W is 140 cm in diam.



Vetro acidato bronzo

Bronze acid glass

La composizione è formata da una base con cassetto, art. KIB236, L 36 cm H 37,5 cm P 54 cm, da un porta lavabo con cassetto art. KIL2108 L 108 cm, H 37,5 cm, P 54 cm, e da una base con cassetto L 54 cm, H 37,5 cm, P 54 cm, art. KIB254. La struttura dell'intera composizione è Rovere thermo, cornice finitura Zirconio, il vetro delle ante è acidato bronzo. Lo specchio con illuminazione a led, art. CIRCUS140W, è Ø 140 cm. Il top in Corian, art. CR154, L 198 cm, P 54 cm ha lavabo integrato art. OPENSLOT108. La rubinetteria appartiene alla collezione AYATI ed è in finitura lucida, art. AY921LU e art. AY600LU.

The composition is made up of a cabinet art. KIB236, L 36 cm H 37,5 cm D 54 cm, a sink unit with drawer art. KIL2108 L 108 cm, H 37,5 cm, D 54 cm, and a cabinet with drawer L 54 cm, H 37,5 cm, D 54 cm, art. KIB254. The entire structure is in Rovere thermo, frame in aluminum with a Zirconium finish, the glass fronts are bronze acid etched. The mirror with led lighting is art. CIRCUS140W, Ø 140 cm. The top in Corian art. CR154, L 198 cm, D 54 cm with integrated sink art. OPENSLOT108. Tap series AYATI in a polished Stainless steel art. AY921LU and art. AY600LU.



Vetro trasparente fumé

Transparent fumé glass

La composizione è formata da una base con anta, art. KAB5236, L 36 cm H 50 cm P 54 cm, da un porta lavabo con doppia anta L 108 cm, H 50 cm, P 54 cm, art. KAL54108, e da una base con doppia anta L 72 cm, H 50 cm, P 54 cm, art. KAB5472.

La struttura dell'intera composizione è Skin cenere, cornice finitura Titanio, il vetro delle ante è trasparente fumé.

Lo specchio con illuminazione a led, art. FLASH75W, è L 216 cm, H 75 cm. Il top L 216 cm, P 54 cm in Flumood Bianco, art. BC154 con lavabo integrato art. PODIO108, è completo di copripiletta art. PIANETTO. La rubinetteria appartiene alla collezione AYATI ed è in finitura lucida, art. AY921LU e art. AY600LU.

The composition is made up of a cabinet with single door art. KAB5236, L 36 cm H 50 cm D 54 cm, a sink unit with double doors measuring L 108 cm, H 50 cm, D 54 cm, art. KAL54108 and a cabinet with double doors L 72 cm, H 50 cm, D 54 cm, art. KAB5472. Structure in Skin cenere, frame in aluminum Titanium finish and transparent fumé glass. The mirror with LED lighting art. FLASH75W, L 216 cm, H 75 cm. Top in white Flumood art. BC154 with integrated sink art. PODIO108, is complete with cover plate art. PIANETTO5. AYATI tap series in polished Stainless steel art. AY921LU and art. AY600LU.





Vetro acidato fumé

Fumé acid glass



Vetro acidato Matita
Laquered Matita acid glass





BESPOKE





Nella foto a sinistra sugli specchi art. NEUTRO1180W45, L 45 cm, H 180 cm, sono inserite le lampade art. LUCENTE45. La composizione è formata da due porta lavabi art. KILM290, L 90 cm, H 37,5 cm, P 47 cm e da una base L 90 cm, H 37,5 cm, P 47 cm, art. KIBM290. La rubinetteria AYATI da piano è in finitura satinata, art. AY303SA. I due lavabi sono in Flumood Bianco art. VERSO. I due pensili, art. ICE4, L 27 cm, H 25 cm, P 14 cm e art. ICE6, L 72 cm, H 25 cm, P 14 cm, hanno lo schienale verniciato Meringa goffrato e il vetro bronzo. L'intera composizione ha la struttura Bianco mood goffrato; cornice finitura Bronzo, frontali Meringa acidato. Il top art. BC147 è in Flumood Bianco.

La composizione nella foto in alto ha la variante dei lavabi in Flumood Bianco art. STRATOS1.

In the picture on the left the mirrors art. NEUTRO1180W45, L 45 cm, H 180 cm and lamps art. LUCENTE45. The composition is made up of two sinks units art. KILM290 L 90 cm, H 37,5 cm, D 47 cm and cabinet L 90 cm, H 37,5 cm, D 47 cm, art. KIBM290. The AYATI tap is art. AY303SA in a satin stainless steel finish. The two sinks are in white Flumood art. VERSO. The two wall cabinets art. ICE4, L 27 cm, H 25 cm, D 14 cm and art. ICE6, L 72 cm, H 25 cm, D 14 cm, the backs are lacquered embossed Meringa and the glass is bronze. The entire composition has the structure embossed Bianco mood; the frames of the drawers are Bronze aluminum and fronts in acid lacquered Meringa. The top art. BC147 is in white Flumood finish.

The composition above has the variant of sinks in white Flumood art. STRATOS1.





BESPOKE



A destra la composizione è formata da due basi, art. KIB2108, L 108 cm H 37,5 cm P 54 cm, la struttura dell'intera composizione è Skin cenere, cornice finitura Zirconio, il vetro delle ante è acidato bronzo, i 2 fianchi art. KL1 sono in Rovere thermo come il top art. IT21. I piedini sono art. PICCO. Il top scatolare è in Flumood Bianco, art. BCS54 con lavabo integrato art. PODIO108 completo di copripiletta art. PIANETTO L 216 cm, P 54 cm, h 12,5 cm. La rubinetteria è della collezione INDIGO finitura grafite art. ND601 e ND921. Specchio art. FILA90W L 216 cm, H 90 cm. Nella foto in alto, vasca art. MASTELLO verniciata colore Lambretta, L 135 cm, H 87 cm, P 75 cm. Rubinetto da terra collezione INDIGO finitura grafite art. ND904. In alto, 2 pensili struttura Skin cenere, cornice finitura Zirconio e ante in vetro trasparente bronzo, art. KE34108, L 108 cm, H 50 cm, P 21,6 cm ciascuno. A sinistra della parete, due appendiabiti in legno massello Rovere naturale art. GRAVITA1 e GRAVITA2.

On the right the composition is made up of two cabinets art. KIB2108, l 108 cm H 37,5 cm D 54 cm, the structure is in Skin cenere frame zirconium, glass is acid bronze and the two sides art. KL1 are in Rovere thermo like the top art. IT21. The feet are art. PICCO. The boxy top is in white Flumood art. BCS54 with integrated sink art. PODIO108 complete with cover art. PIANETTO L 216 cm, D 54 cm H 12,5 cm. INDIGO ta series in graphite art. ND601 and ND921. Mirror art. FILA90W L 216 cm H 90 cm. In the photo above, bathtub art. MASTELLO lacquered Lambretta L 135 cm H 87 cm D 75 cm. INDIGO freestanding tap art. ND904. Above two wall cabinets with structure in skin cenere, frame in zirconium and glass in clear bronze glass art. KE34108, L 108 cm H 50 cm P 21,6. On the left are two hangers in solid natural oak art. GRAVITA1 and GRAVITA2.



BESPOKE





Questa composizione comprende lo specchio art. COLLAGE213, L 70 cm H 90 cm, rubinetteria INDIGO art. ND200, finitura grafite, un top scatolare in Rovere thermo art. BANCO147, L 216 cm, P 47 cm, H 12,5 cm, su cui è appoggiato un lavabo art. SENSOC in Cristalmood Fumé; il mobile L 216 cm, P 47 cm e H 37,5 cm, è composto da tre basi art. KIBM272, e un top in vetro 8 mm art. IT5 Nero acidato. La struttura è Skin cenere, cornici finitura Bronzo, il frontale dei cassetti è in vetro riflettente fumé.

This composition includes a mirror art. COLLAGE213, L 70 cm H 90 cm, tap series INDIGO art. ND200 in the Graphite finish a boxy top in Rovere thermo art. BANCO147 L 216 cm, D 47 cm, H 12,5 cm with sink art. SENSOC in Cristalmood Fumé. The cabinet L 216 cm, D 47 cm, H 37,5 cm is made up of three cabinets art. KIBM272 and a glass top 8 mm thick acid etched black IT5. The structure is skin cenere and the aluminum frames bronze. The drawer fronts in reflective fumé glass.



Questa composizione comprende lo specchio art. COLLAGE221, L 36 cm H 108 cm, lampada art. BOLLA1, rubinetteria INDIGO art. ND921 e ND601, finitura grafite, un top scatolare in Rovere thermo art. TARSIA154, L 216 cm, P 54 cm, H 8 cm, su cui è appoggiato un lavabo art. SENSO in Flumood verniciato color Veneziano. Il mobile è composto da 3 basi con cassetto struttura Skin cenere, cornice finitura Bronzo, frontale dei cassetti in vetro riflettente fumé art. KIBM272, L 72 cm, H 37,5 cm, P 47 cm.

Top in vetro Nero acidato art. IT5.

A destra del mobile, mensola art. OMBRAL colore nero, L 162 cm, con portasalviette art. OMBRAP36 colore nero, L 36 cm. Sulla parete sopra la vasca art. BAIA, verniciata color Veneziano gofrato con rubinetto da terra INDIGO finitura grafite art. ND903, si trovano due colonne struttura Skin cenere, cornice finitura Bronzo e frontali in vetro riflettente fumé art. KC3190, L 90 cm, H 125 cm, P 21,6 cm.



This composition includes mirror art. COLLAGE221, L 36 cm H 108 cm and lamp art. BOLLA1, INDIGO tap series art. ND921 and ND601 graphite finish, a boxy top in Rovere thermo art. TARSIA154 L 216 cm, D 54 cm, and H 8 cm on which sink art. SENSO in Flumood lacquered Veneziano sits. The furniture is made up of 3 cabinets with structure in Skin cenere top in black acid etched glass art. IT5. To the right of the cabinet, shelf art. OMBRAL black, L 162 cm, with towel holder art. OMBRAP36 black, L 36 cm. On the wall above the bathtub art. BAIA, lacquered embossed Veneziano with INDIGO tap in graphite finish art. ND903, there are two columns with Skin cenere structure, Bronze finish frame and fronts in fumè reflective glass art. KC3190, L 90 cm, H 125 cm, D 21.6 cm.





BESPOKE







La composizione è formata da uno specchio art. NEUTRO1180W45, L 45 cm, H 180 cm, sopra la lampada art. BOLLA1. Sul top, art. BANCO154, in essenza Rovere evaporato, L 180 cm, H 12,5 cm, P 54 cm, poggia il lavabo in Flumood Bianco art. SENSO. La rubinetteria AYATI da parete è in finitura satinata, composta da art. AY921SA e da art. AY600SA. Sotto il top, il mobile L 270 cm, è composto da tre basi art. KBB290, ognuna L 90 cm, H 25 cm, P 54 cm. La struttura è Pomice opaco, cornici finitura Bronzo e ante in vetro acidato Pomice. Il top di finitura, art. IT21, è in legno laccato color Pomice opaco. All'interno le attrezzature STRATO art. SRC5490. I due pensili, art. ICE4, L 27 cm, H 25 cm, P 14 cm e art. ICE6, L 72 cm, H 25 cm, P 14 cm, hanno lo schienale verniciato Creta opaco e il vetro fumé. I portasalviette sono di larghezza L 72 cm, art. RETTA472 Creta goffrato.

The composition is made up of a mirror art. NEUTRO1180W45, L 45 cm, H 180 cm, above lamp art. BOLLA1. Top art. BANCO154 in Rovere evaporato, L 180 cm, H 12,5 cm, D 54 cm and white Flumood sink art. SENSO. AYATI tap series in satin finish art. AY921SA and art. AY600SA. Under the top furniture L 270 cm, three cabinets art. KBB290, each L 90 cm, H 25 cm, D 54 cm and finishing top art. IT21. The structure In matt Pomice, frame in aluminum bronze finish and fronts in acid glass lacquered Pomice. Internal drawer accessories STRATO art. SRC5490. The two wall cabinets art. ICE4, L 27 cm, H 25 cm, D 14 cm and art. ICE6, L 72 cm, H 25 cm, P 14 cm, are lacquered matt Creta and fumé glass. Towel rails L 72 cm, art. RETTA472 lacquered embossed Creta.







Il mobile è formato da 3 basi con cassetto Art. KIBM272, struttura Matita gofrato, cornici finitura Bronzo, frontali in vetro riflettente fumé. Il top art. IT5 è in vetro acidato Matita di dimensioni L 216 cm, P 47 spessore 8 mm. Sopra il mobile, due colonne a giorno in vetro trasparente fumé art. ICE2, con schienale Matita gofrato. Il lavabo è l'art. CANALE in Flumood Bianco L 216 cm, P 47 cm, H 12,5 cm. Sopra il lavabo, due specchi NEUTROKIT; uno predisposto per l'inserimento della rubinetteria AYATI art. AY921SA e art. AY600SA, l'altro per l'inserimento del portasalviette art. RETTA454.

The furniture is made up of 3 cabinets with drawer art. KIBM272, structure embossed Matita, frames in Bronze aluminum, fronts in reflective fumè glass.

The top art. IT5 is acid etched lacquered Matita L 216 cm, D 47 and 8 mm thick. Above the furniture two open cabinets in fumè glass art. ICE2 with back panel lacquered embossed Matita.

The sink is art. CANALE in white Flumood L 216 cm, D 47 cm, H 12,5 cm. Above the sink two mirrors NEUTROKIT. One of the mirrors is prepared for the AYATI taps art. AY921SA and art. AY600SA, the other is prepared for the towel bar art. RETTA454.



Vetro laccato acidato Matita.

Laquered Matita acid glass.

In queste immagini la composizione illustrata nella pagina precedente, presenta la variante del top scatolare in Flumood Bianco art. BCS47 di L 216 cm, P 47 cm, H 12,5 cm, sul quale poggia il lavabo in Flumood Bianco art. SIMPLOVALE.



Vetro riflettente fumé

Reflective fumé glass

In this image the composition from the previous page presents an alternative of the boxy top in white Flumood art. BCS47 measuring L 216 cm, P 47 cm, H 12,5 cm with top mount sink in white Flumood art. SIMPLOVALE.



Composizione formata da tre specchi: art. NEUTROLED75W speciale in larghezza L 178 cm, H 75 cm - art. NTKIT50W predisposto per rubinetteria, speciale in larghezza L 178 cm, H 50 cm - art. NEUTROLED50W L 90 cm H 50 cm.

La rubinetteria da parete collezione AYATI, è composta da art. AY921LU e art. AY600LU, mentre quella da piano è l'art. AY301LU. Il mobile, è composto da tre basi con cassetto, L 90 cm, H 25 cm, P 54 cm, art. KBB290; la struttura è color Pomice opaco, cornici finitura Titanio e i frontali sono in vetro acidato Pomice.

Anche il top di finitura, è color Pomice goffrato, art. IT21. Sopra il top art. BCS54 in Flumood Bianco, i lavabi art. SIMPLOTONDO e art. SIMPLO42. All'interno del cassetto, l'attrezzatura STRATO art. SRC5490. Il pensile, con doppia anta, art. KE3790, ha la struttura e le cornici come il mobile, mentre il vetro delle ante è trasparente fumé.

Composition made up of three mirrors art. NEUTROLED75W special in length L 178 cm, H 75 cm, - art. NTKIT50W prepared for tap special in length L 178 cm H 50 cm - art. NEUTROLED50W L 90 cm H 50 cm.

AYATI tap series art. AY921LU and art. AY600LU, mixer tap is art. AY301LU. Furniture from the BESPOKE collection made up of three cabinets with drawers L 90 cm, H 25 cm, P 54 cm, art. KBB290; structure and finishing top art. IT21 lacquered matt Pomice, frames in aluminum titanium finish and fronts in acid glass lacquered Pomice.

Top art. BCS54 in white Flumood, sinks art. SIMPLOTONDO and art. SIMPLO42. Inside the drawer accessories STRATO art. SRC5490. The wall cabinet with double doors art. KE3790 has the structure and frames as the furniture while the glass is transparent fumé.



BESPOKE



Sopra, due composizioni uguali composte da: un lavabo con illuminazione a led, art. STRAPPOL, con rubinetteria AYATI in finitura satinata, art. AY920SA e art. AY600SA, da uno specchio, L 108 cm, H 120 cm, art. NTKIT125W speciale in altezza e predisposto per la rubinetteria. Lo specchio è illuminato dalla lampada art. BOLLA1.

Le colonne sono di uguale altezza e profondità, H 210 cm, P 21,6 cm, ma di due larghezze diverse, L 36 cm e L 54 cm. Per quella di larghezza L 36 cm, la struttura è Cipria gofrato, cornici finitura Titanio e il vetro trasparente fumé. La più grande, si differenzia dalla piccola nel colore del vetro, che in questo caso è Cipria acidato. I pensili art. ICE6, sono L 72 cm, P 14 cm, H 25 cm, lo schienale è colore Cipria lucido mentre il vetro è fumé.



Above, two identical compositions: a sink with LED lighting art. STRAPPOL, AYATI tap series in satin finish art. AY920SA and art. AY600SA, mirror L 108 cm, H 120 cm, art. NTKIT125W custom in height and prepared for taps. The mirror is lit by lamps art. BOLLA1.

High cabinets are the same height and depth H 210 cm, D 21,6 cm but of different width, L 36 cm and L 54 cm. The smaller having a structure lacquered embossed Cipria and frame in aluminum titanium finish and transparent fumé glass while the larger has a different color glass, acid lacquered Cipria. The wall cabinets art. ICE6 L 72 cm, D 14 cm, H 25 cm have a back panel lacquered glossy Cipria while the glass is fumé.









Nella foto a sinistra, due lavabi da terra art. ALBUME11 in Cristalmood Petrolio con basi art. ALBUME30 in Rovere thermo. Rubinetti da terra INDIGO art. ND902 in finitura grafite. Lo specchio è art. APICE50W, L 216 cm, H 50 cm mentre i 2 portasalviette sono in alluminio finitura Titanio art. PLAY72 con un pianetto in Corian art. TAPE11. Il mobile, composto da tre basi L 72 cm, H 25 cm, P 47 cm ciascuna, art. KBBM272, struttura Skin cenere, cornici finitura Titanio, ha vetri argentati fumé e fianchi art. KF1 verniciati Blu navy gofrato. Top in vetro acidato Blu navy art. IT5, L 216 cm, P 47 cm. Sulla parete 4 pensili ICE in vetro fumé art. ICE6, L 72 cm, H 25 cm P 14 cm ciascuno, 2 con schienale verniciato Alga gofrato, 2 verniciati Blu navy gofrato.

Nella foto in alto, attrezzatura cassette collezione STRATO art. SRC4072.

On the left two freestanding sinks art. ALBUME11 in Cristalmood Petrolio with base art. ALBUME30 in Rovere thermo. INDIGO freestanding tap art. ND902 in graphite. The mirror is art. APICE50W L 216 cm H 50 cm and the two towel rails in aluminum finish titanium art. PLAY72 with a Corian surface art. TAPE11. The furniture is made up of 3 cabinets art. KBBM272 L 72 cm H 25 cm P 47 cm structure in Skin cenere, frame in titanium, glass mirrored fumé and sides art. KF1 lacquered embossed Blu navy. Top is acid etched glass lacquered Blu navy art. IT5 L 216 cm D 47 cm. On the wall 4 cabinets art. ICE6 in fume glass L 72 cm H 25 cm D 14 cm, two lacquered embossed Alga and two embossed Blu navy. The picture above internal drawer accessories STRATO art. SRC4072.





La composizione comprende un mobile sospeso con struttura Rovere thermo, cornici finitura Bronzo, ante in vetro trasparente bronzo, formato da tre basi con due ante ciascuna, L 90 cm P 47 cm H 37,5 cm art. KIBM5490, il top art. IT21 è in essenza Rovere thermo.

The composition has suspended furniture with carcass and top art. IT21 in Rovere thermo, frames in Bronze aluminum, fronts in transparent bronze glass, made up of three double door cabinets, L 90 cm D 47 cm art. KIBM5490.



Mobile sospeso composto da tre basi con struttura e fianchi Rovere thermo e cornici finitura Titanio, ante con vetri trasparenti fumé, art. KIBM5490, L 90 cm, H 37,5 cm, P 47 cm ciascuna.

Top in Rovere thermo. Sopra uno specchio della collezione COLLAGE art. COLLAGE358, L 72 cm, H 50 cm. A destra due lavabi da terra art. PLISSÉ in Flumood Bianco con rubinetti da terra AYATI in finitura satinata art AY902SA; gli specchi sono art. BSK210W90 L 90 cm, H 210 cm con cornice finitura Titanio e lampade art. BOLLA1.



Suspended cabinet made up of three cabinets in Rovere thermo and frame titanium, fronts in clear fumè glass art. KIBM5490 L 90 H 37,5 D 47 each. Top is in Rovere thermo. Above the composition mirror art. COLLAGE358 L 72 cm H 50 and to the right two freestanding sinks art. PLISSE' in white Flumood with freestanding AYATI taps art. AY902 in satin stainless steel; mirrors art. BSK210W90 L 90 H 210 cm with titanium frame and lamp art. BOLLA1.



I lavabi in Flumood Bianco art. TUBAMOOD, si completano con la rubinetteria AYATI in finitura lucida art. AY902LU.
Gli specchi con illuminazione a led e cornice Titanio art. BSK210W90, sono di L 90 cm, H 210 cm.

The sinks are in white Flumood art. TUBAMOOD and AYATI tap series art. AY902LU polished. The mirrors with LED lighting have a frame in aluminum titanium finish art. BSK210W90 L 90 cm, H 210 cm.



Sopra, due pensili L 90 cm, H 50 cm, P 21,6 cm, art. KE3490, struttura Matita opaco, cornici finitura Bronzo e ante in vetro argentato fumé. Sotto, sanitari in finitura satinata, art. KOMODO3 e art. KOMODO4 con rubinetteria AYATI in finitura lucida art. AY400LU. Sono in finitura lucida anche la placca di comando art. ONDA e gli accessori della collezione PLAY.

Above, two wall cabinets L 90 cm, H 50 cm, P 21,6 cm, art. KE3490, structure in matt Matita, frame in aluminum bronze finish and fronts in transparent fumé glass. Below, sanitary ware art. KOMODO3 and art. KOMODO4 in a matt finish with AYATI tap series art. AY400LU polished as is art. ONDA flushing plate and the PLAY accessories series.



La colonna art. KC3472, L 72 cm, H 150 cm, P 21,6 cm, è composta da due ante con struttura in Rovere thermo, cornici finitura Bronzo e ante in vetro argentato bronzo. All'interno delle ante gli specchi art. KS3.

The high cabinet art. KC3472, L 72 cm, H 150 cm, D 21,6 cm has two fronts and structure in Rovere thermo, frame in aluminum Bronze finish and fronts in bronze mirrored glass. On request it is possible to insert a mirror on the inside of the doors art.KS3.











BESPOKE





Nella foto a sinistra i due specchi con illuminazione a led della collezione BESPOKE art. BSK210W90 di L 90 cm, H 210 cm con cornice in alluminio finitura Titanio. In alto, due top in essenza Rovere thermo uno di L 216 cm, ed uno di L 180 cm, H 12,5 cm, P 54 cm, art. BANCO154. Sopra i top, due lavabi in Flumood Bianco art. URNAMOOD con rubinetteria AYATI in finitura lucida, art. AY600LU e art. AY921LU. Il mobile è formato da tre basi speciali con cassetto, L 108 cm, H 37,5 cm, P 47 cm, per una larghezza totale di L 324 cm. La struttura è Skin cenere, cornici finitura Titanio e i frontali sono in vetro acidato fumé.

On the left the two mirrors with led lighting from the BESPOKE collection art. BSK210W90, L 90 cm, H 210 cm with frame in aluminum Titanium finish. Above two tops in wood essence Rovere thermo one measuring L 216 cm, and the other L 180 cm, H 12,5 cm, D 54 cm art. BANCO154. On the top two sinks in white Flumood art. URNAMOOD with tap series AYATI in a polished stainless steel finish art. AY600LU and art. AY921LU. The furniture is made up of three custom cabinets, L108 cm H 37,5 cm, D 47 cm, for a total length of L 324 cm. The structure is in Skin cenere, frame in aluminum titanium finish and fronts are in acid etched fumé glass.



Le colonne con doppia anta, art. KC39108, L 108 cm, H 175 cm P 47 cm hanno la struttura Skin cenere, cornici in finitura Titanio e i frontali in vetro argentato fumé.



Columns with double doors art. KC39108, L 108 cm, H 175 cm D 47 cm have the structure In Skin cenere, frame of doors in aluminum titanium finish and fronts in mirrored fumé glass.



La vasca è in Cristalplant art. DAFNE, con rubinetteria AYATI art. AY903SA, termoarredo BITLIGHT art. BITL120E, L 45 cm, H 120 cm, Pomice gofrato. Le colonne, con struttura Skin cenere e cornici finitura Titanio, sono tutte di uguale altezza e profondità, H 150 cm, P 47 cm; quattro sono di larghezza L 36 cm, art. KC1636, due con frontale in vetro trasparente fumé e due con vetro argentato fumé. L'ultima colonna di destra, art. KC3672, L 72 cm è composta da due ante di L 36 cm, il frontale è in vetro acidato fumé.

The bathtub in Cristalplant art. DAFNE and AYATI tap series art. AY903SA, BITLIGHT radiator art. BITL120E, L 45 cm, H 120 cm, lacquered embossed Pomice.

The high cabinets with structure in Skin cenere and frame in aluminum Titanium finish, H 150 cm, P 47 cm; four L 36 cm, art. KC1636, two glass fronts transparent fumé and two mirrored fumé glass.

The last high cabinet on the right art. KC3672, L 72 cm double doors in acid fumé glass.



BESPOKE



Composizione formata da cinque colonne di H 175 cm, la struttura è Skin cenere, le cornici sono in finitura Titanio e i frontali in vetro trasparente fumé.

Le colonne sono di diversa larghezza, a partire da sinistra, L 45 cm art. KC1745, a sinistra e a destra del camino di L 72 cm con doppia anta art. KC3772, L 45 cm art. KC1745, L 36 cm art. KC1736. La vasca a semincasso in Cristalplant art. DUNE2 e il camino art. CANTOMC63, con bruciatore a bioetanolo art. LAFLACA, appartiene alla collezione CANTO DEL FUOCO.



Composition made up of five high cabinets H 175 cm, the structure in Skin cenere, the frames are in aluminum titanium finish and fronts in transparent fumé glass.
The high cabinets are of different widths, starting from the left, L 45 cm art. KC1745, two L 72 cm with double fronts art. KC3772, L 45 cm art. KC1745, L 36 cm art. KC1736. The bathtub in Cristalplant art. DUNE2 and fireplace art. CANTOMC63 is from the CANTO DEL FUOCO series, with bioethanol burner art. LAFLACA









BESPOKE







Nella foto in alto, sei colonne art. KC79108 con struttura Rovere Thermo, cornice finitura Bronzo, frontali sono in vetro trasparente bronzo.

Above six high cabinets art. KC79108 with structure in Rovere thermo frame in Bronze and fronts in clear bronze glass.





Su richiesta:
l'armadiatura comprende tre colonne a due ante con struttura in Noce canaletto, cornici finitura bronzo e ante in vetro trasparente fumé. Le dimensioni delle tre colonne sono L 90 cm, H 210 cm, P 40 cm.

*Upon request:
the wall system includes three high cabinets and two fronts with structure in Noce canaletto, frame in aluminum bronze finish and fronts in transparent fumé glass. The dimensions of the three cabinets are L 90 cm, H 210 cm, D 40 cm.*



BESPOKE LEGENDA - KEY

La struttura e i fianchi di serie sono in finitura Skin cenere, su richiesta è possibile personalizzare i fianchi esterni in finitura laccata o in essenza legno.

The structure and the side panels are in skin cenere, upon request you can personalize the external side panels lacquered or veneered.

FIANCO DI SERIE | STANDARD SIDE

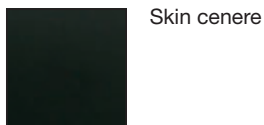

Skin cenere

FIANCO PERSONALIZZATO VERNICIATO O IN ESSENZA LEGNO | PERSONALIZED SIDE LACQUERED OR VENEERED



Verniciato opaco, goffrato, lucido o finitura seta come da nostro campionario colori.

Lacquered matt, embossed, glossy or silk finish as per our color samples.

art.

KF1



Rovere:
sbiancato, naturale castano, moro,
grigio, matita, ardesia, thermo.

Noce:
canadese, visone, canaletto.

Essenza legno

Wood essence

art.

KL1

BESPOKE LEGENDA - KEY

Per calcolare il prezzo di un elemento è necessario scegliere la finitura della struttura identificata dalle lettere **R, S, e T** e la finitura della cornice. Ante e cassetti non possono essere abbinati in un'unica composizione, la composizione dovrà essere o tutta ante o tutta cassetti.

*To calculate the price of an element you should select the finish of the structure identified by letters **R, S and T** and the finish of the frame. Doors and drawers can't be combined in the same composition, which has to be all with doors or all with drawers.*

FINITURE INTERNE | INTERNAL FINISH

R

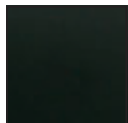

Skin cenere

S

Verniciato opaco, gofrato, lucido o finitura seta come da nostro campionario colori

Lacquered matt, embossed, glossy or silk finish as per our color samples



T

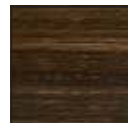

Rovere:
sbiancato, naturale castano, moro, grigio, matita, ardesia, thermo.

Noce:
canadese, visone, canaletto.

FINITURE CORNICI | FRAME FINISH

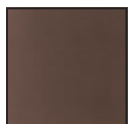

Bronzo



Champagne



Bianco opaco
Matt white



Titanio



Zirconio



Nero opaco
Matt black

BESPOKE LEGENDA - KEY

Inoltre per calcolare il prezzo di un elemento è necessario scegliere la finitura dei frontali identificata dai numeri **1 e 2**.

Also to calculate the price of an element you should select the finish of the front identified by numbers **1 and 2**.

FINITURE FRONTALI ANTE E CASSETTI | FRONT DOOR AND DRAWER FINISH **1|2**



1



Vetro trasparente bronzo
Transparent bronze glass

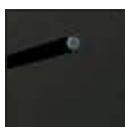

Vetro trasparente fumé
Transparent fumé glass



Vetro argentato naturale
Natural mirrored glass



Vetro argentato bronzo
Bronze mirrored glass



Vetro argentato fumé
Fumé mirrored glass



Vetro cannettato trasparente
Ribbed clear glass

2



Vetro riflettente fumé
Reflective fumé glass

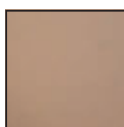

Vetro acidato bronzo
Bronze acid glass

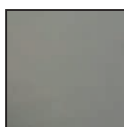

Vetro acidato fumé
Fumé acid glass



Vetro acidato laccato come da nostro campionario colori.
Acid glass lacquered as per our color samples.

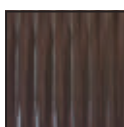

Vetro cannettato laccato come da nostro campionario colori.
Ribbed glass lacquered as per our color samples.



BESPOKE COMPONENTI - COMPONENTS

PORTA LAVABI | SINK UNITS

Porta lavabo con 1 cassetto Art. SLIM sagomato internamente per sifone.

Sink unit with 1 drawer Art. SLIM internally shaped for siphon.

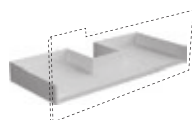

H	P	L
25	40	54 - 63 - 72 - 90 - 108
	47	
	54	

Porta lavabo con 1 cassetto Art. SLIM.

Large drawer sink unit Art. SLIM.



H	P	L
37,5	40	54 - 63 - 72 - 90 - 108 - 126
	50	47
	54	

Porta lavabo con 2 cassetti Art. SLIM di cui 1 sagomato internamente per sifone.

Sink unit with 2 drawers Art. SLIM of which 1 internally shaped for siphon.

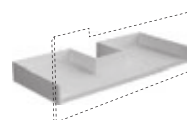
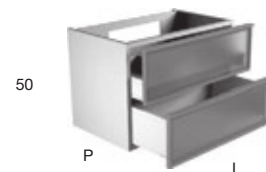

H	P	L
50	40	54 - 63 - 72 - 90 - 108
	47	
	54	

PORTA LAVABI | SINK UNITS

Porta lavabo dx o sx con 1 anta.

Right or left single door sink unit.

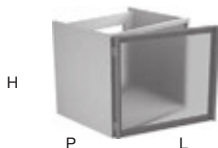

H	P	L
37,5	40	36 - 45
	47	
	54	

50	40	36 - 45 - 54
	47	
	54	

Porta lavabo con 2 ante.

Double door sink unit.

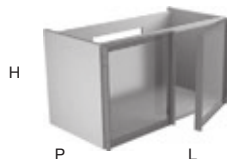

H	P	L
37,5	40	72 - 90
	47	
	54	

50	40	72 - 90 - 108
	47	
	54	

BASI | CABINETS

Base con 1 cassetto Art. SLIM.

Single drawer cabinet Art. SLIM.



H	P	L
25	40	36 - 45 - 54 - 63 - 72 - 90 - 108 - 126
	47	
	54	

Base con 1 cassetto Art. SLIM.

Single drawer cabinet Art. SLIM.



H	P	L
37,5	40	36 - 45 - 54 - 63 - 72 - 90 - 108 - 126
	50	47
	54	

Base con 2 cassetti Art. SLIM.

Cabinet with 2 drawers Art. SLIM.



H	P	L
50	40	36 - 45 - 54 - 63 - 72 - 90 - 108
	47	
	54	

Base con 2 cassetti Art. SLIM.
Cabinet with 2 drawers Art. SLIM.



H	P	L
37,5	40	36 - 45 - 54 - 72 - 90 - 108
50	47	
	54	

Base dx o sx con 1 anta.
Cabinet with 1 right or left door.

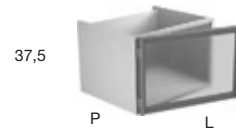

H	P	L
37,5	40	36 - 45
	47	
	54	

Base con 2 ante.
Double door cabinet.



H	P	L
37,5	40	72 - 90
	47	
	54	

BASI | CABINETS ▽

BESPOKE

Base dx o sx con 1 anta e 1 ripiano interno.
Cabinet with 1 right or left door and 1 internal shelf.

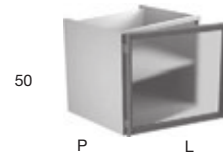

H	P	L
50	40	36 - 45 - 54
	47	
	54	

Base con 2 ante e 1 ripiano interno.
Double door cabinet and 1 internal shelf.



H	P	L
50	40	72 - 90 - 108
	47	
	54	

BASI | CABINETS ▽

Pensile dx o sx con 1 anta.
Right or left single door wall cabinet.

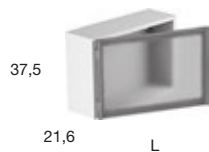

H	P	L
37,5	21,6	36 - 45

Pensile dx o sx con 1 anta e 1 ripiano interno.
Right or left single door wall cabinet with 1 internal shelf.

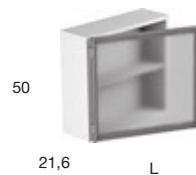

H	P	L
50	21,6	36 - 45 - 54

Pensile dx o sx con 1 anta e 2 ripiani interni.
Right or left single door wall cabinet with 2 internal shelves.



H	P	L
75	21,6	36 - 45 - 54

PENSILI | WALL CABINETS ▽

BESPOKE COMPONENTI - COMPONENTS

PENSILI | WALL CABINETS

Pensile dx o sx con 1 anta e 3 ripiani interni.
Right or left single door wall cabinet with 3 internal shelves.



H	P	L
100	21,6	36 - 45 - 54

Pensile con 2 ante.
Double door wall cabinet.

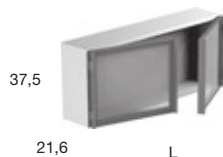

H	P	L
37,5	21,6	72 - 90

Pensile con 2 ante e 1 ripiano interno.
Double door wall cabinet with 1 internal shelf.

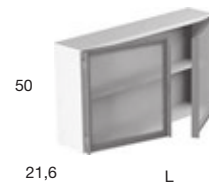

H	P	L
50	21,6	72 - 90 - 108

PENSILI | WALL CABINETS

Pensile con 2 ante e 2 ripiani interni.
Double door wall cabinet with 2 internal shelves.

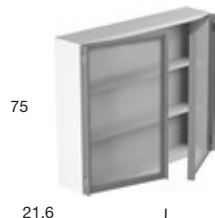

H	P	L
75	21,6	72 - 90 - 108

Pensile con 2 ante e 3 ripiani interni.
Double door wall cabinet with 3 internal shelves.



H	P	L
100	21,6	72 - 90 - 108

COLONNE | HIGH CABINETS

Colonna dx o sx con 1 anta e 3 ripiani interni.
Right or left single door high cabinet with 3 internal shelves.



H	P	L
125	21,6	36 - 45 - 54
	33,6	
	47	

Colonna dx o sx con 1 anta e 4 ripiani interni.
Right or left single door high cabinet with 4 internal shelves.



H	P	L
150	21,6	36 - 45 - 54
	33,6	
	47	

Colonna dx o sx con 1 anta e 5 ripiani interni.
Right or left single door high cabinet with 5 internal shelves.



H	P	L
175	21,6	36 - 45 - 54
	33,6	
	47	

Colonna dx o sx con 1 anta e 6 ripiani interni completa di piedini regolabili.

Right or left single door high cabinet with 6 internal shelves and regulating feet.



H	P	L
210	21,6	36 - 45 - 54
	33,6	
	47	

Colonna con 2 ante e 3 ripiani interni.

Double door high cabinet with 3 internal shelves.



H	P	L
125	21,6	72 - 90 - 108
	33,6	
	47	

Colonna con 2 ante e 4 ripiani interni.

Double door high cabinet with 4 internal shelves.



H	P	L
150	21,6	72 - 90 - 108
	33,6	
	47	

COLONNE | HIGH CABINETS ▽

BESPOKE

Colonna con 2 ante e 5 ripiani interni.

Double door high cabinet with 5 internal shelves.



H	P	L
175	21,6	72 - 90 - 108
	33,6	
	47	

Colonna con 2 ante e 6 ripiani interni completa di piedini regolabili.

Double door high cabinet with 6 internal shelves and regulating feet.



H	P	L
210	21,6	72
	33,6	
	47	

COLONNE | HIGH CABINETS ▽

Colonna dx o sx con 1 anta e 2 ripiani interni in vetro trasparente bronzo o fumé con profilo in alluminio e 2 cassetti. Versione a terra completa di piedini regolabili.

Right or left high cabinet with 1 door and 2 internal glass shelves bronze or fume with aluminum profile and 2 drawers. Freestanding version comes complete with regulating feet.



H	P	L
175	47	36 - 45 - 54

Colonna con 2 ante e 2 ripiani interni in vetro trasparente bronzo o fumé con profilo in alluminio e 2 cassetti. Versione a terra completa di piedini regolabili.

High cabinet with 2 doors and 2 internal glass shelves bronze or fume, with aluminum profile and 2 drawers. Freestanding version comes complete with regulating feet.



H	P	L
175	47	72 - 90 - 108

COLONNE | HIGH CABINETS ▽

ATELIER

2018

design_Mario Ferrarini

Un programma ampio e articolato nella sua semplicità, una serie di mobili dal design pulito e rigoroso che offre molteplici possibilità di combinazione grazie all'utilizzo di pochissimi elementi. Atelier, la serie di mobili contenitori dalle linee essenziali disegnata da Mario Ferrarini, trova nell'anta l'elemento decorativo che esalta la composizione.

L'anta è composta da un profilo in alluminio con frontale in legno che a seconda di come viene posizionato all'interno del profilo, crea una gola o maniglia donando un segno grafico alla composizione.

La gola può essere posta in orizzontale totalmente o parzialmente rispetto allo sviluppo del mobile, ma anche collocata lungo i lati verticali o addirittura "incorniciare" i quattro lati, permette di personalizzare questa microarchitettura domestica conferendo profondità alla superficie.

Disponibile in tutte le essenze legno e in tutta la gamma colori laccati di antoniolupi, Atelier è una collezione sartoriale, come da dna dell'azienda e vive sulla combinazione di moduli di svariate dimensioni.

A wide and articulated program in its simplicity, a series of furniture with a clean and rigorous design that offers multiple possibilities of combinations thanks to the use of very few elements. Atelier, the series of furniture with essential lines designed by Mario Ferrarini, with a decorative element in the door that enhances the composition.

The door is composed of an aluminum profile with a wooden front which, depending on how it is positioned inside the profile, creates a groove or handle donating a graphic sign to the composition.

The handle can be placed horizontally, totally or partially, with respect to the rest of the furniture, but also placed along the vertical sides or even "frame" the four sides allowing you to customize a domestic micro-architecture and give depth to the surface.

Available in all wood types and in the full range of antoniolupi lacquered colors, Atelier is a tailored collection, inspired by the company's DNA, based on a combination of modules in various sizes.











Questa composizione comprende lo specchio art. NEUTRO75, L 180 cm H 75 cm, con lampada art. LUCENTE180; rubinetteria INDIGO art. ND301 finitura grafite. Il mobile, verniciato Smoke seta, è composto da un portalavabo art. ATIL290 con maniglia "B" sinistra in finitura Zirconio, e una base art. ATIB290 con maniglia "G" sinistra in finitura Zirconio. La composizione si completa con attrezzatura interna per cassetti DOMINO. Il top in Colormood Smoke, art. BC154 L 180 cm P 54 cm Sp. 1,2 cm, ospita il lavabo integrato art. BASICO54. Carta da parati TRALERIGHE, art. V2P e art. C2P. Tappeto della collezione TRAMATO art. TR250 L 200 cm P 132 cm.

This composition includes the mirror art. NEUTRO75 L 180 cm H 75 cm with lamp art. LUCENTE180; INDIGO tap art. ND301 graphite finish. The furniture is lacquered satin Smoke is made up of a sink unit art. ATIL290 with LH "B" handle in zirconium finish. The composition is completed with internal drawer accessories DOMINO. The top is in Colormood Smoke art. BC154 L 180 cm D 54 cm and 1,2 cm thick with integrated sink art. BASICO54.

Wallpaper TRALERIGHE art. V2P and art. C2P. Carpet from the TRAMATO collection art. TR250 L 200 cm D 132 cm.













Il mobile in Rovere thermo è composto da due porta lavabi art. ATIL290 L 90 cm, H 37,5 cm, P 54 cm ciascuno e due basi art. ATIB245 L 45 cm, H 37,5 cm, P 54 cm ciascuna, il tutto con gola in orizzontale per tutta la lunghezza, i fianchi esterni del mobile sono in Rovere thermo art. ATL1.

Il top in Flumood Bianco, è art. BC154 con due lavabi integrati art. NUVOLA, sopra i rubinetti Indigo art. ND301 in acciaio satinato. I pensili a specchio sono due Mantra art. MANTRA275 L 90 cm, H 75 cm, P 14,7 cm con struttura in Skin cenere con alla sua sinistra, due lampade art. BOLLA1 e due appendiabiti in legno massello Rovere naturale art. GRAVITA1 e GRAVITA2. Sulla parete a destra della composizione troviamo due colonne a due ante con specchi all'interno e quattro ripiani art. ATC3590, L 90 cm, H 150 cm, P 33,6 cm.

The cabinet in Rovere thermo is made up of two sink units art. ATIL290 L 90 cm H 37,5 cm D 54 cm each and two cabinets art. ATIB245 L 45 cm H 37,5 cm D 54 cm each with horizontal handle and external sides in Rovere thermo art. ATL1.

The top is in white Flumood art. BC154 with two integrated sinks art. NUVOLA, INDIGO taps art. ND301 in satin steel. Mirrored wall cabinets are art. MANTRA275 L 90 cm H 75 cm P 14,7 cm with structure in Skin cenere with lamps art. BOLLA1 on the left. Two clothes hangers in solid wood Rovere naturale art. GRAVITA1 and GRAVITA2. On the right-hand wall two high cabinets with double doors and mirror on the inside art. ATC3590 L 90 cm, H 150 cm D 33,6 cm.





Box doccia art. COMBI120 versione sinistra, vetro extrachiaro H 220 cm completo di asta in acciaio satinato art. COMBI1. Piatto doccia in Moodlight art. SM_COMBI90, L 175 cm, P 90 cm. Rubinetteria Mayday art. MAYDAYD, deviatore in acciaio satinato e art. MAYDAY, miscelatore in acciaio verniciato bianco, doccia in acciaio satinato e flessibile in silicone bianco art. FILO. Il soffione è un art. FMS20C_BAL, con telaio bianco, completo di illuminazione LED rgb e telecomando waterproof. La vasca in Flumood Bianco è art. MASTELLO. Rubinetto da terra Indigo art. ND904 in acciaio satinato. Gli scaldasalviette sulla parete sono due Stecca, color ovatta goffrato art. STECCA60, L 60 cm e art. STECCA90, L 90 cm.

Shower enclosure art. COMBI120 left version extraclear glass H 220 cm complete with satin steel bar art. COMBI1. Shower tray in Moodlight art. SM_COMBI90 L 175 cm D 90 cm. Mayday tap series art. MAYDAYD deviator in satin steel and art. MAYDAY mixer lacquered white hand shower in satin steel and hose in white silicone art. FILO. The overhead shower is art. FMS20C_BAL with white frame and rgb led lighting and waterproof remote. The bathtub in white Flumood is art. MASTELLO freestanding INDIGO tap art. ND904 in satin steel. The two towel warmers are art. STECCA60 L 60 cm and art. STECCA90 L 90 cm lacquered embossed Ovatta.



Il mobile con gole ad "L", composto da due portalavabi art. ATIL272, L 72 cm, H 37,5 cm, P 54 cm e due basi art. ATIB236, L 36 cm, H 37,5 cm, P 54 cm, ha struttura Skin cenere, cornici finitura Bronzo con frontali laccati color Ovatta goffrato.
I due top in Flumood Bianco sono art. BC154 con due lavabi integrati art. BRECCIA, L 144 cm, P 54 cm ciascuno.
L'attrezzatura dei cassetti è collezione Strato.
I rubinetti INDIGO in finitura grafite sono due art. ND301. Lo specchio Ø 140 cm è un art. CIRCUS140W. Sopra lo specchio, nella nicchia, 4 lampade ad incasso art. ZENITLED in alluminio nero.



The composition is made up of two sink units art. ATIL272 L 72 cm H 37,5 cm D 54 cm and four cabinets art. ATIB236 L 36 cm H 37,5 cm D 54 cm with structure in skin cenere frame in bronze aluminum and lacquered fronts embossed Ovatta. The two tops in white Flumood art. BC154 with two integrated sinks art. BRECCIA L 144 cm D 54 cm each. Internal drawer accessories are STRATO. INDIGO tap series graphite finish art. ND301. The mirror art. CIRCUS140W is Ø 140 cm. Above the mirror 4 encased spotlights art. ZENITLED.









Box doccia art. COMBI180 versione destra in vetro fumè, H 220 cm completo di profili e asta in acciaio inox satinato. Piatto doccia in Moodlight art. SM_COMBI180, L 149 cm, P 80 cm. Rubinetteria Mayday art. MAYDAYD, deviatore in acciaio satinato e art. MAYDAY, miscelatore in finitura grafite, doccetta in finitura grafite e flessibile in silicone nero art. FILTRO. I soffioni LAMATTONELLA sono gli art. LMN_2A e art. LMN3_A; i faretti sono due art. ZENITLED. A parete termoarredo BITLIGHT art. BITL180E completo di due art. GANCIOLIGHT, il tutto in finitura Brown goffrato; illuminazione ad incasso art. SCRIGNO. La composizione viene completata dal wc sospeso, appartenente alla collezione KOMODO, art. KOMODO3 in finitura satinata, dalla placca ONDA in finitura grafite e dalla colonna a giorno incassata, in finitura Skin cenere, art. DIMEZZO.

Shower enclosure art. COMBI180 right version in fumè glass, H 220 cm complete with satin stainless steel profiles and bar. Shower tray in Moodlight art. SM_COMBI180, L 149 cm, D 80 cm. MAYDAY tap series art. MAYDAYD, satin steel diverter and mixer art. MAYDAY in a Graphite finish, handshower art. FILTER in graphite and flexible black silicone hose. The overhead showers Lamattonella are art. LMN_2A and art. LMN3_A; The spotlights are two art. ZENITLED. Wall-mounted radiators Bitlight art. BITL180E complete with two art. GANCIOLIGHT, all in the embossed Brown finish; Recessed lighting art. SCRIGNO. The Composition is completed by the suspended WC, belonging to the Komodo collection, art. KOMODO3 in satin finish, art. ONDA flush plate in graphite finish and the encased tall unit in Skin cenere art. DIMEZZO.





ATELIER



Nella foto uno specchio art. COLLAGE309, L 54 cm, H 75 cm, rubinetto AYATI art. AY301LU in finitura lucida. Il mobile L 180 cm, H 37,5 cm e P 54 cm con gola ad "L", è composto da un porta lavabo art. ATIL290, da due basi art. ATIB245 e un top in Flumood Falena con lavabo integrato, art. NIDO72, con pianetto opzionale art. PIANETTO2; la struttura è Skin cenere, le cornici in finitura Bronzo. I lati esterni del mobile sono laccati Ovatta gofrato art. ATF1. I frontali dei cassetti sono laccati Ovatta gofrato.



In the photo a mirror art. COLLAGE309, L.54 cm, H.75 cm, AYATI tap art. AY301LU in polished steel. The furniture L 180 cm, H 37,5 cm and D 54 cm with handle in an "L" shape is made up of a sink unit art. ATIL290, two cabinets art. ATIB245 and a top in Flumood Falena with integrated sink art. NIDO72 and optional cover art. PIANETTO2 in white color. The structure is in Skin cenere and the aluminum frame in Bronze. The external sides of the cabinets are lacquered embossed Ovatta art. ATF1 and the fronts are lacquered embossed Ovatta.





Nella foto lo specchio a sinistra è l'art. COLLAGE318, quello a destra è l'art. COLLAGE307, entrambi L 54 cm, H 75 cm. Le due composizioni, con rubinetti INDIGO art. ND301 in finitura grafite, sono di L 135 cm, H 37,5 cm e P 47 e sono composte da un porta lavabo art. ATILM290, da una base art. ATIBM245 e un top in Flumood Bianco art. BC147 con lavabo integrato art. BASICO47; la struttura è Skin cenere, le cornici sono in finitura Champagne. I lati esterni del mobile sono laccati Blu navy goffrato art. ATF1 come i frontali dei cassetti. Le due composizioni differiscono dalle posizioni delle gole.

In the picture on the left art. COLLAGE318, the one on the right is art. COLLAGE307 both measuring L 54 cm, H 75 cm. The two compositions with INIDGO tap art. ND301 in the graphite finish are L 135 cm, H 37,5 and D 47 cm made up of a sink unit art. ATILM290, two cabinets art. ATIBM245 and a top in white Flumood art. BC147 with integrated sink art. BASICO47; the structure is in skin cenere the aluminum frame in champagne finish. The external sides of the cabinets are lacquered embossed Blu Navy art. ATF1 as the drawer fronts. The two compositions are different due to the position of the handles.



Nella foto specchio art. COLLAGE213, L 70 cm, H 90 cm, rubinetteria INDIGO art. ND301 finitura grafite.
Il mobile, con gola ad "F", è composto da un porta lavabo art. ATIL290 e una base art. ATIB290, struttura in Skin cenere, cornici finitura Bronzo, frontali laccati Ossido goffrato. Le due colonne, art. ATC1836 e art. ATC1845, hanno struttura in Skin cenere, cornici finitura Bronzo, frontali laccati Ossido goffrato
Il top in Flumood con lavabo integrato colore Falena, art. NUVOLA.



*In the photo mirror art. COLLAGE213 L 70 cm H 90 cm INDIGO tap series art. ND301 graphite finish.
The cabinet with "F" type handle has a sink unit art. ATIL290 and a cabinet art. ATIB290 structure in
skin cenere, frame bronze fronts lacquered embossed Ossido. The two high cabinets art. ATC1836
and art. ATC1845 have structure in skin cenere frame in bronze fronts lacquered embossed Ossido.
The top is in Flumood Falena with integrated sink art. NUVOLA.*









ATELIER

Verniciabile in tutti i colori del nostro campionario

Can be lacquered in all colors of our collection





A parete due lampade art. BOLLA1 con specchio art. NEUTRO50 di L 144 cm, H 50 cm posizionato verticalmente. La composizione comprende inoltre un rubinetto INDIGO art. ND301 in finitura grafite. Il mobile L 135 cm, H 37,5 cm e P 54 cm con gola in orizzontale per tutta la lunghezza, è composto da un porta lavabo art. ATIL290, da una base art. ATIB245 e un top in Flumood Serena art. BC154 con lavabo integrato art. NIDO54, con pianetto opzionale art. PIANETTO1; la struttura è Skin cenere, le cornici sono in finitura Bronzo. I lati esterni del mobile sono in Rovere thermo art. ATL1. I frontali dei cassetti sono in Rovere thermo.

Above two lamps art. BOLLA1 with mirror art. NEUTRO50 L 144 cm, H 50 cm hung vertically. The composition also includes the tap INDIGO art. ND301 in the graphite finish. The furniture L 135 cm, H 37,5 and D 54 cm with horizontal handle for the entire length is made up of a sink unit art. ATIL290, cabinet art. ATIB245 and a top in Flumood with integrated sink art. NIDO54 and optional cover art. PIANETTO1 in the Serena; the structure is in Skin cenere and aluminum frame in Bronze finish. The external sides of the cabinets are in Rovere thermo art. ATL1, the fronts are in Rovere thermo.





Nella composizione abbiamo uno specchio art. CIRCUS1108W con illuminazione a led comprensivo di lampada LUCENTE, rubinetteria INDIGO art. ND301 in finitura grafite. Il mobile L 162 cm, H 37,5 cm e P 54 cm con gola in orizzontale per tutta la lunghezza, è composto da un porta lavabo art. ATIL2108, da una base art. ATIB254 e un top in Flumood Serena art. BC154 con lavabo integrato art. NIDO54, con pianetto opzionale art. PIANETTO1; la struttura è Skin cenere, le cornici sono in finitura Titanio. I lati esterni del mobile sono in Noce canaletto art. ATL1. I frontali dei cassetti sono in Noce canaletto.

The composition includes a mirror art. CIRCUS1108W with lamp LUCENTE, tap series INDIGO art. ND301 in graphite finish. The furniture is L 162 cm H 37,5 and D 54 with horizontal handle along the entire length: sink unit art. ATIL2108, and cabinet art. ATIB254 with top in Flumood and integrated sink art. NIDO54 and optional cover art. PIANETTO1 in the Serena color. The structure of the cabinet is in Skin cenere, aluminum frame in the Titanium finish, the external sides of the cabinets are in Noce canaletto and the fronts are in Noce canaletto.

ATELIER COMBINAZIONI MANIGLIE - HANDLE COMBINATIONS

La gola può essere posta in orizzontale totalmente o parzialmente rispetto allo sviluppo del mobile, ma anche collocata lungo i lati verticali o addirittura “incorniciare” i quattro lati, permette di personalizzare questa microarchitettura domestica conferendo profondità alla superficie.

The handle can be placed horizontally, totally or partially, with respect to the rest of the furniture, but also placed along the vertical sides or even “frame” the four sides allowing you to customize a domestic micro-architecture giving depth to the surface.



TIPOLOGIE DI MANIGLIE | TYPE OF HANDLES



ATELIER COMBINAZIONI MANIGLIE - HANDLE COMBINATIONS

ESEMPI - EXAMPLES

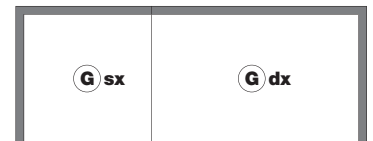
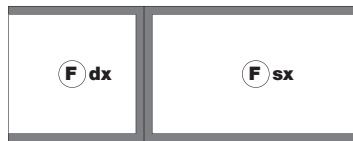
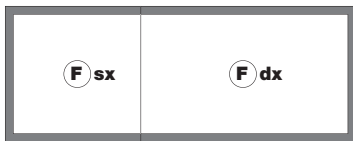
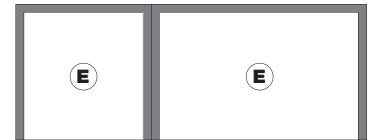
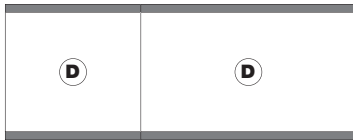
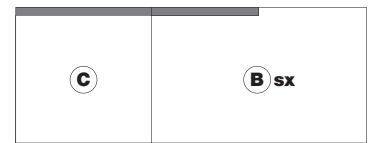
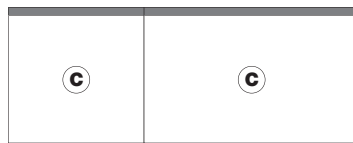

ATELIER



Composizione con maniglia
C | C

Composition with handle
C | C



Composizione con maniglia
D | D

Composition with handle
D | D



Composizione con maniglia
G sx | C

Composition with handle
G sx | C



Composizione con maniglia
G sx | G dx

Composition with handle
G sx | G dx

ATELIER



Composizione con maniglia
F dx | F sx

Composition with handle
F dx | F sx



Composizione con maniglia
F sx | F dx

Composition with handle
F sx | F dx

ATELIER LEGENDA - KEY

La struttura e i fianchi di serie sono in finitura Skin cenere, su richiesta è possibile personalizzare i fianchi esterni in finitura laccata o in essenza legno.

The structure and the side panels are in skin cenere, upon request you can personalize the external side panels lacquered or veneered.

FIANCO DI SERIE | STANDARD SIDE

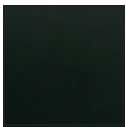

Skin cenere

FIANCO PERSONALIZZATO VERNICIATO O IN ESSENZA LEGNO | PERSONALIZED SIDE LACQUERED OR VENEERED



Verniciato opaco, goffrato, lucido o finitura seta come da nostro campionario colori.

Lacquered matt, embossed, glossy or silk finish as per our color samples.

art.

ATF1



Rovere:
sbiancato, naturale castano, moro,
grigio, matita, ardesia, thermo.

Noce:
canadese, visone, canaletto.

Essenza legno

Wood essence

art.

ATL1

ATELIER LEGENDA - KEY

Per calcolare il prezzo di un elemento è necessario scegliere la finitura dei frontali identificata dal numero **3 e 4** e la finitura della cornice.

To calculate the price of an element it is necessary to select the finish of the front(s) identified by the numbers **3 and 4** and the finish of the frame.

FINITURE FRONTALI | FRONT FINISH **3|4**

FINITURE CORNICI | FRAME FINISH



CORNICE | FRAME

3



Verniciato opaco, gofrato, lucido o finitura seta come da nostro campionario colori.



Lacquered matt, embossed, glossy or silk finish as per our color samples.

4

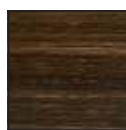

Rovere: sbiancato, naturale castano, moro, grigio, matita, ardesia, thermo.

Noce: canadese, visone, canaletto.

FINITURE CORNICI | FRAME FINISH



Bronzo

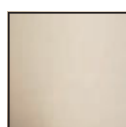

Champagne



Bianco opaco
Matt white



Titanio



Zirconio



Nero opaco
Matt black

PORTA LAVABI E BASI | SINK UNITS AND CABINETS

Porta lavabo con 1 cassetto Art. SLIM.
Large drawer sink unit Art. SLIM.

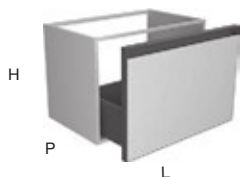

H	P	L
37,5	40	54 - 63 - 72 - 90 - 108 - 126
50	47	
	54	

Base con 1 cassetto Art. SLIM.
Single drawer cabinet Art. SLIM.

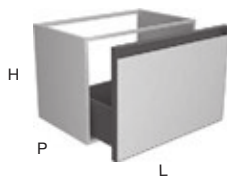

H	P	L
37,5	40	36 - 45 - 54 - 63 - 72 - 90 - 108 - 126
50	47	
	54	

COLONNE | HIGH CABINETS

Colonna dx o sx con 1 anta e 3 ripiani interni, completa di specchio argentato naturale spess. 3 mm all'interno dell'anta.
Right or left single door high cabinet with 3 internal shelves, complete with internal 3 mm mirror on door.

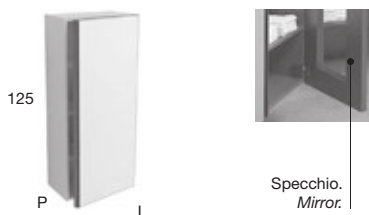

H	P	L
125	21,6	36 - 45 - 54
	33,6	
	47	

Colonna dx o sx con 1 anta e 4 ripiani interni, completa di specchio argentato naturale spess. 3 mm all'interno dell'anta.
Right or left single door high cabinet with 4 internal shelves, complete with internal 3 mm mirror on door.



H	P	L
150	21,6	36 - 45 - 54
	33,6	
	47	

Colonna dx o sx con 1 anta e 5 ripiani interni, completa di specchio argentato naturale spess. 3 mm all'interno dell'anta.
Right or left single door high cabinet with 5 internal shelves, complete with internal 3 mm mirror on door.



H	P	L
175	21,6	36 - 45 - 54
	33,6	
	47	

COLONNE | HIGH CABINETS

Colonna con 2 ante e 3 ripiani interni, completa di specchio argentato naturale spess. 3 mm all'interno delle ante.
Double door high cabinet with 3 internal shelves, complete with internal 3 mm mirror on doors.



H	P	L
125	21,6	72 - 90 - 108
	33,6	
	47	

Colonna con 2 ante e 4 ripiani interni, completa di specchio argentato naturale spess. 3 mm all'interno delle ante.
Double door high cabinet with 4 internal shelves, complete with internal 3 mm mirror on doors.



H	P	L
150	21,6	72 - 90 - 108
	33,6	
	47	

Colonna con 2 ante e 5 ripiani interni, completa di specchio argentato naturale spess. 3 mm all'interno delle ante.
Double door high cabinet with 5 internal shelves, complete with internal 3 mm mirror on doors.

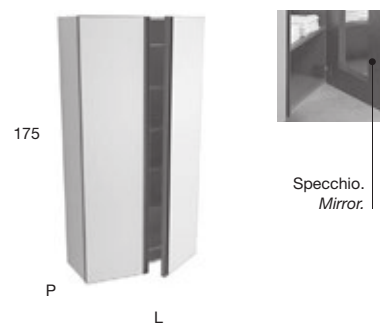

H	P	L
175	21,6	72 - 90 - 108
	33,6	
	47	



ATELIER

L' affiancamento di 2 colonne è possibile solo come da esempio. Non è possibile affiancare più di 2 colonne.

You can install 2 high cabinets side by side as follows. It is not possible to install more than 2 high cabinets side by side.

ESEMPI DI COMBINAZIONI COLONNE | EXAMPLES OF HIGH CABINET COMBINATIONS



SI | YES

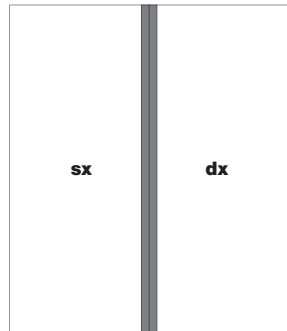

SI | YES

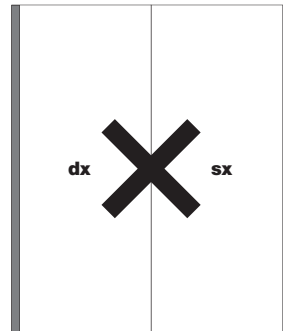

NO | NO

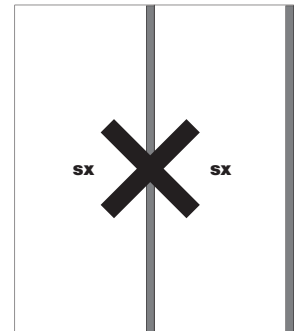

NO | NO

- A - Muratura**
- Masonry
 - Mauer
 - Mur
 - Pared
 - Стена

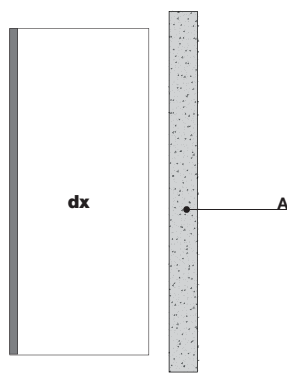

2,5

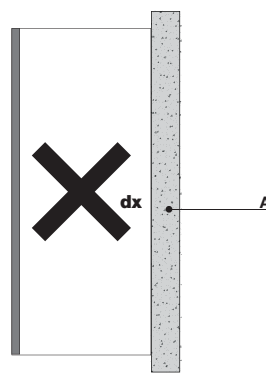

PANTA REI

2006

design_Carlo Colombo

Eccellenza che diventa esclusività, per un lusso contemporaneo fatto di linee pulite e forme essenziali, materiali naturali e dettagli preziosi che trasmettono armonia ed equilibrio all'insieme.

La qualità unica delle lavorazioni unita alla possibilità di scegliere dimensioni, colori e finiture fanno di Panta Rei una collezione sartoriale all'insegna dell'eccellenza. I mobili, disponibili in finitura laccata o in essenza e i lavabi della collezione, comunicano un universo di valori e principi fondanti nei quali la qualità diventa il filo conduttore del progetto, in grado di sollecitare un mondo di sensazioni intime e arcaiche, di riti che si ripetono nel tempo, di abitudini che si trasformano nel segno della continuità.

Un'identità forte, nella quale gli spessori dei contenitori, esteticamente importanti, sono alleggeriti e sollevati da terra dallo zoccolo smussato e dal particolare taglio a 45° dei profili, che oltre a snellire in maniera significativa anche le sezioni a forte spessore, contribuisce a migliorare la qualità estetica complessiva dell'insieme. La perfezione raggiunta con Panta Rei nella laccatura e nell'impiallacciatura ha segnato un punto di svolta per antoniolupi, ha definito uno standard d'eccellenza che è stato da quel momento trasmesso a tutta la produzione. Da quel momento in poi il livello qualitativo diventerà il parametro di riferimento per ogni prodotto, l'attenzione ai dettagli il tratto distintivo di un modo di operare e prima di tutto di pensare.

La preziosità del legno, il calore delle essenze più ricercate, l'uniformità perfetta dei laccati opachi, i riflessi dei lucidi: la materia diventa design con Panta Rei, la qualità di ogni singolo elemento viene messa a servizio dell'immagine complessiva, del dialogo con le forme dei lavabi, della capacità di interpretare lo spazio, della volontà di definire un ambiente bagno senza confini.

Excellence that becomes exclusive for contemporary luxury made of clean lines and basic shapes, natural materials and precious details that convey harmony and balance.

The unique quality of workmanship coupled with the ability to choose sizes, colors and finishes make Panta Rei a tailored collection characterized by excellence. The furniture, available in a lacquered or wood finish communicate with the sinks of the collection.

A strong identity, in which the thicknesses of the cabinets, aesthetically important, are lightened and raised from the ground by the beveled plinth and details cut at 45°. The lacquering and veneering achieved with the Panta Rei collection clearly marked a turning point for the company setting a standard of excellence transmitted to the rest of the production. From that moment on, the quality will become the benchmark for each product, the attention to detail; the hallmark of a way of working and thinking.

The preciousness of the woods, warmth from the most sought after materials, the perfect uniformity of the matt lacquers and the reflections of the glossy colours: matter becomes design with Panta Rei. The quality of each element is put in the service of the overall image, dialogue with the shapes of the sinks, the ability to interpret the space, the desire to define a bathroom environment without borders.



PANTA REI



Lo specchio è un art. VARIO50W, L 180 cm, H 50 cm con due coppie di lampade art. BOLLA2, la composizione sottostante di L 180 cm, P 54 cm, H 37,5 cm è formata dal mobile in Rovere thermo art. PI14180 e dal top in Flumood art. BC254 colore Falena con buca integrata, art. NIDO54.

Il rubinetto AYATI è un art. AY301LU.



The mirror is art. VARIO50W, L 180 cm, H 50 cm with a pair of lamps art. BOLLA2, the composition below is L 180 cm, D 54 cm, H 37,5 cm is made up of cabinet art. PI14180 in Rovere thermo and top in Flumood Falena art. BC254 with integrated basin art. NIDO54. The AYATI tap is art. AY301LU.





PANTA REI

La composizione è arricchita dall'inserimento del pianetto copripiletta art. PIANETTO1, dai cassetti interni opzionali art. SLIM54 e dall'attrezzatura STRATO in vetro fumé.

The composition is completed with the drain cover art. PIANETTO1 and the internal optional drawers art. SLIM54 with STRATO drawer dividers in fumé glass.



Questa composizione comprende lo specchio retroilluminato art. NEUTROLED75W, L 180 cm H 75 cm, rubinetteria INDIGO art. ND921, art. ND601, finitura acciaio satinato.

Il mobile, in legno Rovere castano, è composto da un modulo asimmetrico art. PI14180 versione dx; si completa con l'attrezzatura interna STRATO in vetro fumè art. SRC5490 e art. SRC5445.

Il top in Colormood Basalto art. BC254 L 180 cm P 54 cm Sp 1,2 cm, ospita un lavabo integrato art. NUVOLA Prof. 54 cm.

Tappeto della collezione GEOMETRIE VOLANTI art. GV336 L 300 cm P 200 cm.

This composition includes the backlit mirror art. NEUTROLED75W L 180 cm H 75 cm INDIGO tap art. ND921 and art. ND601 in satin steel finish. The cabinet is in Rovere castano art. PI14180 right-hand version is completed with internal drawer accessories STRATO in fume glass art. SRC5490 and art. SRC5445

The top is in Colormood Basalto art. BC254 L 180 cm D 54 cm 1,2 cm thick houses an integrated sink art. NUVOLA 54 cm D. Carpet from GEOMETRIE VOLANTI collection art. GV336 L 300 cm D 200 cm



PANTA REI



Questa composizione comprende due specchi retroilluminati art. CIRCUS108W, rubinetteria INDIGO art. ND921, art. ND601, finitura cromo lucido. Il mobile, verniciato gofrato Meringa, è composto da una base art. PI4180, due porta lavabi art. PI5490 e due basi art. PI5654. I due lavabi in appoggio art. RIM76 sono in Flumood Bianco. Vasca art. REFLEXMOOD in Flumood Bianco, rubinetteria INDIGO art. ND903 finitura cromo lucido. I tre scaldasalviette, art. STECCA120, L 120 cm P 7 cm H 12 cm sono verniciati gofrati nei colori Bambola, Veneziano e Pompeiano. Tappeto della collezione GEOMETRIE VOLANTI art. GV329 L 300 cm P 200 cm.



This composition includes two backlit mirrors art. CIRCUS108W, INDIGO tap series art. ND921 art. ND601 polished chrome finish. The cabinets lacquered embossed Meringa have a cabinet art. PI4180, two sink units art. PI5490 and two cabinets art. PI5654. The two top mount sinks are art. RIM76 in white Flumood. Bathtub art. REFLEXMOOD in white Flumood INDIGO tap art. ND903 polished chrome. The three towel warmers art. STECCA120 L 120are lacquered embossed Bambola, Veneziano and Pompeiano. Carpet from the GEOMETRIE VOLANTI art. GV329 L 300 cm D 200 cm.





PANTA REI





PANTA REI





Questa composizione comprende lo specchio art. COLLAGE365 L 54 cm H 75 cm, rubinetteria INDIGO art. ND921 e art. ND601 finitura grafite. Il mobile, verniciato gofrato Veneziano, è composto da due basi art. PI5472 e una base art. PI5672 e contiene l'attrezzatura interna STRATO in vetro fumè art. SRC5472. Il top scatolare in Flumood Falena art. BCS54, L 216 cm H 12,5 cm P 54 cm, ospita il lavabo in appoggio art. SENSOC in Cristalmood Nebbia; completa la composizione l'alzatina paraschizzi nella stessa finitura del top. Tappeto della collezione GEOMETRIE VOLANTI art. GV520 L 400 cm P 100 cm.

This composition includes the mirror art. COLLAGE365 L 54 cm H 75 cm, INDIGO tap series art. ND921 and art. ND601 graphite finish. The cabinet is lacquered embossed Veneziano and is made up of two cabinets art. PI5472 with internal drawer accessories STRATO in fume glass art. SRC5472. The boxy top in Flumood Falena art. BCS54 L 216 cm H 12,5 cm D 54 cm houses a top mount sink art. SENSOC in Cristalmood Nebbia; to complete the composition the backsplash is in the same material as the top Carpet GEOMETRIE VOLANTI art. GV520 L 400 cm D 100 cm.





A sinistra la composizione è formata dai sanitari sospesi art. KOMODO3 e art. KOMODO4 satinati, rubinetteria INDIGO art. ND400 finitura grafite, placca art. ONDA finitura grafite. A parete la mensola e la colonna a giorno da incasso art. DIMEZZO e art. FRAMEZZO entrambe in finitura Skin cenere. Completa la composizione lo scaldasalviette art. STECCA60, L 60 cm H 12 cm P 7 cm verniciato goffrato Tortora. Sopra vasca in Cristalplant art. DUNE2 e portasalviette art. HALO4A con basamento in marmo Carrara satinato, struttura finitura Bianca opaco e vassoio in Flumood Bianco.

To the left the composition is made up of suspended sanitary ware art. KOMODO3 and art. KOMODO4 in a satin finish, INDIGO tap art. ND400 in the graphite finish, flush plate art. ONDA in graphite. Encased in the wall art. DIMEZZO and art. FRAMEZZO both in Skin cenere. Towel warmer art. STECCA60 L 60 cm H 12 cm D 7 cm lacquered embossed Tortora. Above the Cristalplant bathtub art. DUNE2 and towel holder art. HALO4A with base in satin Carrara marble, structure in matt white and tray in Flumood.



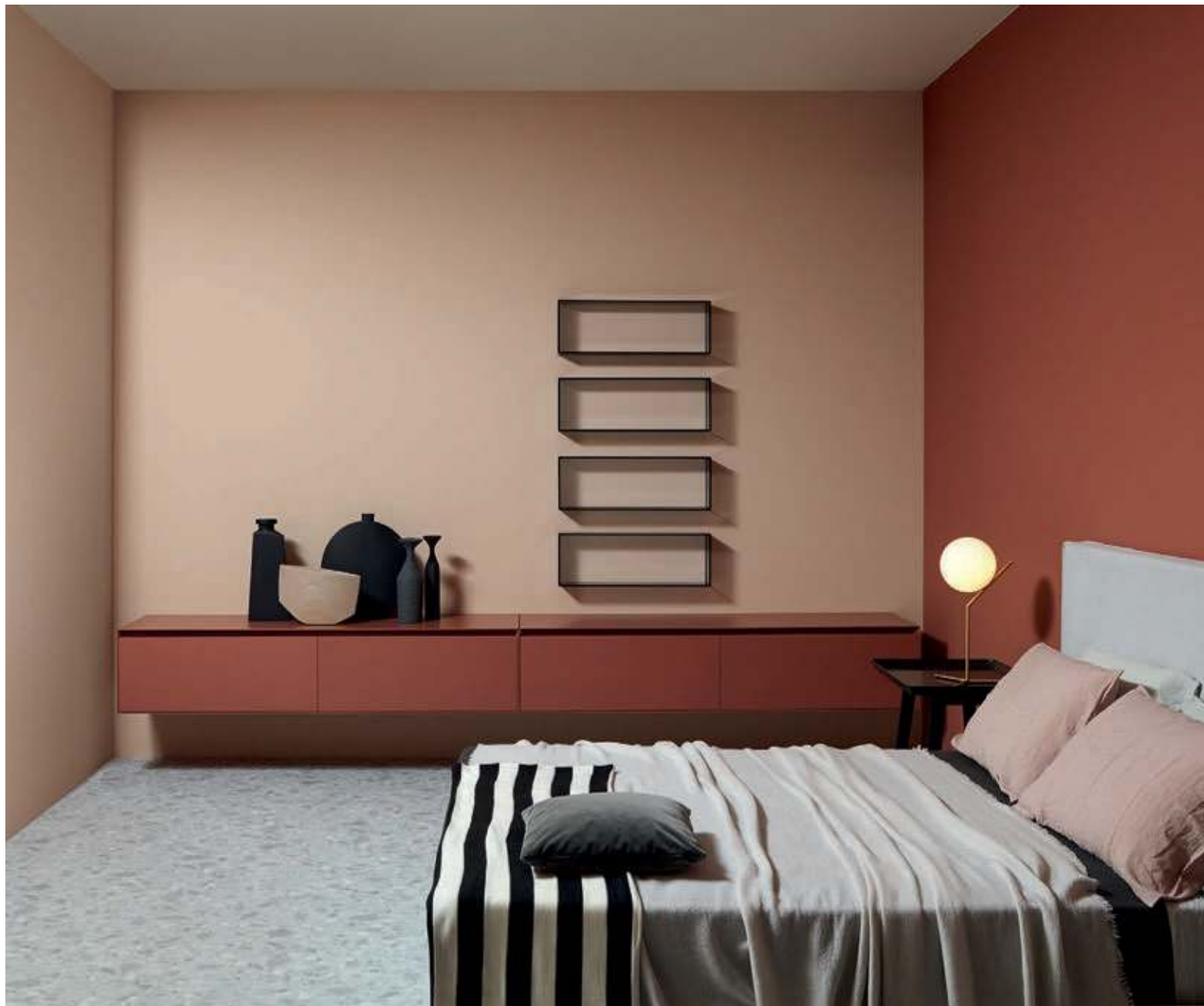

In questa composizione il mobile, verniciato goffrato Veneziano, è composto da due basi art. PI4180. A parete quattro pensili art. ICE6, L 72 cm H 25 cm P 14, con schienale verniciato Cipria lucido e vetro trasparente fumè.

In this composition the cabinet lacquered embossed Veneziano is made up of two cabinets art. PI4180. On the wall four open cabinets art. ICE6 L 72 cm H 25 cm D 14 cm with back lacquered glossy Cipria and fume colored glass.



Specchio art. NEUTROLED50W di L 180 cm, H 50 cm, rubinetteria AYATI art. AY921LU e art. AY600LU, lavabo da appoggio in Flumood Bianco art. BOLOMOOD45. Il mobile PANTA REI DOBLE è composto da due basi art. PI5645 di L 45 cm e da un porta lavabo art. PI5490 L 90 cm, tutti H 37,5 cm e P 54 cm, colore Terracotta lucido.

Mirror art. NEUTROLED50W measuring L 180 cm, H 50 cm, AYATI taps art. AY921LU and art. AY600LU, top mount sink art. BOLOMOOD45 in white Flumood. The furniture PANTA REI DOBLE is made up of two cabinets art. PI5645 L 45 cm and one sink unit art. PI5490 L 90 cm all H 37,5 cm and D 54 cm, lacquered glossy Terracotta.



Specchio art. NEUTROLED50W di L 216 cm, H 50 cm, rubinetteria AYATI art. AY921LU e art. AY600LU, e lavabo da appoggio in Flumood Bianco art. BOLOMOOD45. Il mobile PANTA REI DOBLE è composto da due basi art. PI5672 di L 72 cm e da un portalavabo art. PI5472 L 72 cm, H 37,5 cm e P 54 cm, colore Terracotta lucido.

Mirror art. NEUTROLED50W measuring L 216 cm, H 50 cm, AYATI taps art. AY921LU and art. AY600LU, top mount sink art. BOLOMOOD45 in white Flumood. The furniture PANTA REI DOBLE is made up of two cabinets art. PI5672 L 72 cm and a sink unit art. PI5472 L 72 cm, H 37,5 cm and D 54 cm, lacquered glossy Terracotta.





PANTA REI





PANTA REI

La composizione in colore Pomice gofrato è formata da cinque colonne art. PC1145 di L 45 cm, H 175 cm, P 22 cm.

The composition is embossed lacquered Pomice and made up of five high cabinets art. PC1145, each is L 45 cm, H 175 cm, D 22 cm.





Lo specchio a sinistra è un art. COLLAGE222, quello a destra è l'art. COLLAGE221, entrambi L 36 cm e H 108 cm, la composizione sottostante è l'art. PI22180 di L 180 cm, P 54 cm, H 37,5 cm in finitura Rovere thermo, più il top in Flumood Bianco art. BC254, con due buche integrate art. NIDO72 e pianetto opzionale art. PIANETTO2. I rubinetti sono della serie AYATI art. AY301SA in acciaio satinato.

The mirror to the left is art. COLLAGE222, the one on the right is art. COLLAGE221, both L 36 cm and H 108 cm. The composition below is art. PI22180 measuring L 180 cm, D 54 cm H 37,5 cm in Rovere thermo with a top in white Flumood art. BC254 with two Integrated sinks art. NIDO72 and optional surface art. PIANETTO2. The tap series AYATI art. AY301SA in satin stainless steel.





Questa composizione comprende due specchi art. MANTRA275 L 72 cm H 75 cm ciascuno, la rubinetteria è composta dall'erogatore AYATI art. AY921SA in finitura satinata e dal miscelatore art. MINIMAYDAY verniciato bianco. Il mobile, verniciato gofrato Bianco mood, è composto da una base art. PB4144 ed è completo di attrezzatura interna STRATO in vetro fumè art. SRC5472.

Il top scatolare in Flumood Bianco art. BCS54, L 144 cm H 12,5 cm P 54 cm, ospita il lavabo integrato art. OSM54.

This composition is made up of two mirrors art. MANTRA275 L 72 cm each, Ayati tap art. AY921 in satin stainless steel and MINIMAYDAY mixer lacquered white. The cabinet lacquered embossed Bianco mood is made up of a cabinet art. PB4144 with internal drawer accessories STRATO in fume glass art. SRC5472.

The boxy top in white Flumood art. BCS54 L 144 cm H 12,5 cm D 54 cm with integrated sink art. OSM54.









Questa composizione comprende lo specchio art. VERTICE75W, L 216 cm H 75 cm, con specchio ingranditore FOCUS; rubinetteria AYATI art. AY921SA e art. AY600SA in finitura satinata. Il mobile, verniciato Cemento lucido, è composto da una base art. PI4180 e due porta lavabi art. PI4144 ed è completo di attrezzatura interna STRATO in vetro fumè. Il mobile ospita i due lavabi da appoggio art. OPALE10 in Cristalmood Ginger. A parete quattro pensili a giorno art. ICE6, L 72 cm H 25 cm P 14, con schienale verniciato Bianco opaco e vetro extrachiaro. Completa la composizione il tappeto della collezione GEOMETRIE VOLANTI art. GV52 L 400cm P 100 cm.

This composition includes the mirror art. VERTICE75W, L 216 cm H 75 cm, with FOCUS magnifying mirror; AYATI taps art. AY921SA and art. AY600SA in satin finish. The cabinet is lacquered in glossy Cemento, is made up of a cabinet art. PI4180 and two sink units art. PI4144 and is complete with STRATO internal drawer accessories in fumè glass. The cabinet houses the two top mount sinks art. OPALE10 in Cristalmood Ginger. Four open wall units art. ICE6, L 72 cm H 25 cm D 14, with matt white painted back and extra-clear glass. The composition is completed by the carpet from the GEOMETRIE VOLANTI collection art. GV52 L 400cm P 100 cm.



La composizione comprende tre mobili, due in essenza Noce biondo L 162 cm, P 54 cm, H 25 cm, art. PB24162 e uno laccato Bianco opaco di L 216 cm, H 25 cm, P 54 cm, art. PB4216. I lavabi sono in Pietra Luna art. PILA11, con rubinetteria BIKAPPA finitura lucida art. BK200N. Lo specchio L 162 cm, H 75 cm, art. FLASH75W.



PANTA REI

The composition Includes three cabinets, two in Noce biondo L 162 cm, D 54 cm, H 25 cm, art. PB24162 and one lacquered matt Bianco L 216 cm, H 25 cm, D 54 cm, art. PB4216. The sinks in Pietra Luna art. PILA11 with BIKAPPA polished finish tap art. BK200N. The mirror L 162 cm, H 75 cm, art. FLASH75W.









La composizione comprende uno specchio su misura, un mobile L 180 cm, P 54 cm, H 25 cm, laccato Bianco opaco, art. PB4180. Lavabo in Flumood Bianco art. URNAMOOD. La rubinetteria è BIKAPPA in finitura lucida art. BK905N.

The composition includes a special size mirror, cabinet L 180 cm, D 54 cm, H 25 cm lacquered matt Bianco art. PB4180. sinks in white Flumood art. URNAMOOD. Polished BIKAPPA tap art. BK905N.





Composizione con un mobile L 216 cm, P 54 cm, H 37,5 cm, in essenza Noce biondo art. PI4216, con zoccolo laccato Nero goffrato, art. PZ54, ed un mobile laccato Bianco opaco art. PB4216. Lavabo in Flumood Bianco art. URNAMOOD. La rubinetteria è BIKAPPA in finitura lucida art. BK905N. Lo specchio art. FLASH50W è L 216 cm, H 50 cm.

The composition with cabinet L 216 cm, D 54 cm, H 37,5 cm in Noce biondo art. PI4216, Nero embossed lacquered plinth art. PZ54 and a lacquered cabinet matt Bianco art. PB4216. Sink in white Flumood art. URNAMOOD. Polished BIKAPPA tap art. BK905N. The mirror art. FLASH50W L 216 cm, H 50 cm.



La composizione comprende tre mobili, due in essenza Rovere grigio L 180 cm, P 54 cm, H 25 cm, art. PB4180 e uno laccato Bianco opaco di L 180 cm, H 25 cm, P 54 cm, art. PB4180. Il lavabo è in Flumood Bianco art. URNAMOOD e la rubinetteria è BIKAPPA finitura lucida art. BK200N. Lo specchio, L 180 cm H 75 cm art. FLASH75W.

The composition includes three cabinets, two in Rovere grigio L 180 cm, D 54 cm, H 25 cm, art. PB4180 and one lacquered matt Bianco L 180 cm, H 25 cm, D 54 cm, art. PB4180. Sink in white Flumood art. URNAMOOD and BIKAPPA polished finish tap art. BK200N. The mirror L 180 cm H 75 cm art. FLASH75W.



PANTA REI





La composizione comprende tre mobili, un porta lavabo L 72 cm, P 54 cm, H 50 cm, in essenza Rovere sbiancato art. PA272, un porta lavabo L 90 cm, P 54 cm, H 25 cm, art. PB290 laccato Bianco opaco, una base L 108 cm, P 54 cm, H 25 cm, art. PB2108 in essenza Rovere sbiancato. I lavabi art. URNAMOOD, sono in Flumood Bianco, la rubinetteria è BIKAPPA finitura lucida, art. BK200N. Lo specchio è art. NEUTROLED142W L 72 cm H 142 cm.

The composition includes three cabinets, one sink unit L 72 cm, D 54 cm, H 50 cm in Rovere sbiancato art. PA272, a sink unit L 90 cm, D 54 cm, H 25 cm, art. PB290 lacquered matt Bianco, a cabinet L 108 cm, D 54 cm, H 25 cm, art. PB2108 in Rovere sbiancato. The sinks art. URNAMOOD, in white Flumood, BIKAPPA polished finish tap art. BK200N. Mirror art. NEUTROLED142W L 72 cm H 142 cm.





La composizione comprende uno specchio art. FLASH100W, rubinetteria AYATI in finitura lucida, art. AY921LU e art. AY600LU. Il mobile è composto da due moduli, ognuno di L 144 cm, H 37,5 cm, P 54 cm, art. PI4144 laccati Ovatta lucido. Lavabi da appoggio in Flumood Bianco art. RETTOMOOD50. Di lato alla composizione, il camino CANTO DEL FUOCO art. CANTOMC63 con bruciatore art. LAFLACA.

The composition includes a mirror art. FLASH100W, AYATI taps in a polished finish art. AY921LU and art. AY600LU. The furniture is made up of two cabinets each L 144 cm, H 37,5 cm, D 54 cm, art. PI4144 lacquered glossy Ovatta. White Flumood top mount sinks art. RETTOMOOD50. Next to the composition is a fireplace CANTO DEL FUOCO art. CANTOMC63 and burner art. LAFLACA.





La composizione in essenza Rovere grigio, comprende due moduli di L 216 cm, P 54 cm, H 25 cm, art. PB4216 e art. PB20216, due lavabi in Flumood Bianco art. RETTOMOOD63, rubinetteria AYATI, finitura satinata, art. AY921SA e art. AY600SA. Lo specchio L 216 cm, H 75 cm, è l'art. FLASH75W. I pensili art. PE136, L 36 cm, H 75 cm, sono laccati Cemento opaco; i sanitari in ceramica satinata sono l'art. KOMODO3 e l'art. KOMODO4. Completano la composizione, gli accessori della collezione TAPE, in acciaio inox satinato AISI 304, come la placca di comando art. ONDA.

The composition in Rovere grigio includes two cabinets L 216 cm, D 54 cm, H 25 cm, art. PB4216 and art. PB20216, two white Flumood sinks art. RETTOMOOD63, AYATI taps in a satin finish art. AY921SA and art. AY600SA. The mirror L 216 cm, H 75 cm, is art. FLASH75W. Wall cabinets art. PE136, L 36 cm, H 75 cm, are lacquered matt Cemento; the sanitary ware in satin ceramic art. KOMODO3 and art. KOMODO4. To complete the composition are the TAPE accessories in satin stainless steel AISI 304 as is the plate art. ONDA.





A sinistra, la composizione comprende uno specchio L 36 cm, H 108 cm, art. SPIO4W, un mobile in Rovere matita L 180 cm, H 37,5 cm, P 54 cm, art. PI4180. Lavabo in Flumood Bianco, art. FOGLIOMOOD63 e rubinetteria BIKAPPA in finitura lucida art. BK200N. Sopra, soluzione con rubinetteria AYATI in finitura satinata art. AY200SA.

On the left, the composition includes a mirror L 36 cm, H 108 cm, art. SPIO4W, a cabinet in Rovere matita L 180 cm, H 37,5 cm, D 54 cm, art. PI4180. White Flumood sink art. FOGLIOMOOD63 and BIKAPPA taps in polished chrome finish art. BK200N. Above solution with the AYATI tap in satin art. AY200SA.





La composizione comprende un mobile art. PA10216, L 216 cm, P 54 cm, H 50 cm, laccato Grigio vesuvio opaco, sopra i due lavabi in Pietra Vesuvio art. PILA11. La rubinetteria è BIKAPPA in finitura lucida art. BK200N. Gli specchi sono L 36 cm, H 108 cm, art. SPI04W.

The composition includes a cabinet art. PA10216, L 216 cm, D 54 cm, H 50 cm lacquered matt Grigio Vesuvio with two sinks art. PILA11 in Pietra Vesuvio. Polished BIKAPPA tap art. BK200N. Mirrors L 36 cm, H 108 cm, art. SPI04W.





PANTA REI

La composizione comprende uno specchio art. FLASH75W, L 180 cm, H 75 cm, il mobile art. PI4180, L 180 cm, P 54 cm, H 37,5 cm e il top in Corian L 180 cm, art. CR254, con lavabo integrato art. MYSLOT90. La rubinetteria è BIKAPPA in finitura lucida art. BK200N.

The composition includes mirror art. FLASH75W, L 180 cm, H 75 cm. The cabinet art. PI4180, L 180 cm, D 54 cm, H 37,5 cm and the top in Corian L 180 cm, art. CR254 with integrated sink art. MYSLOT90. Polished BIKAPPA tap art. BK200N.





PANTA REI

La composizione in alto comprende un pensile con anta a specchio art. SEGRETO, la rubinetteria AYATI è in finitura lucida, art. AY302LU, il top in Corian art. CR254 con lavabo integrato è l'art. SEGNO90 e il mobile PANTA REI CENTRO, L 180 cm, H 50 cm, P 54 cm, art. PA36180 è laccato Ovatta gofrato. Gli accessori sono della collezione PLAY.

The composition on top includes a wall cabinet with mirrored door art. SEGRETO, AYATI tap in the polished finish art. AY302LU, Corian top art. CR254 with integrated sink art. SEGNO90 and the cabinet PANTA REI CENTRO, L 180 cm, H 50 cm, D 54 cm, art. PA36180 lacquered embossed Ovatta. Accessories from the PLAY series.





La composizione in alto comprende uno specchio art. NEUTROLED75W di L 216 cm, H 75 cm, la rubinetteria AYATI in finitura satinata art. AY200SA e due lavabi da appoggio in Flumood Bianco art. CATINO. Il mobile PANTA REI CENTRO art. PA32216 è di L216 cm, H 50 cm e P 54 cm, laccato Cemento lucido.

The composition above has a mirror art. NEUTROLED75W L 216 cm, H 75 cm, the AYATI tap in satin finish art. AY200SA and two top mount sinks in white Flumood art. CATINO. The cabinet PANTA REI CENTRO art. PA32216 is L 216 cm, H 50 cm and D 54 cm lacquered glossy Cemento.



Composizione con uno specchio L 216 cm, H 75 cm, art. FLASH75W, un mobile L 216 cm, P 54 cm, H 25 cm, in essenza Rovere castano art. PB4216. Top in Corian art. CRS15, con due lavabi integrati art. SLOT. La rubinetteria BIKAPPA è in finitura lucida art. BK200N.

Composition with a mirror L 216 cm, H 75 cm, art. FLASH75W, a cabinet L 216 cm, D 54 cm, H 25 cm in Rovere castano art. PB4216. Top in Corian art. CRS15 with two integrated sinks art. SLOT. Polished BIKAPPA tap art. BK200N.



PANTA REI





La composizione comprende due specchi art. FLASH100W e due top in essenza Noce canaletto L 144 cm, H 12,5 cm art. BANCO154, due lavabi da appoggio in Flumood Bianco art. URNAMOOD. La rubinetteria è AYATI in finitura satinata art. AY921SA e art. AY600SA. Il mobile PANTA REI CENTRO laccato Strada opaco L 72 cm, H 50 cm, P 54 cm, art. PA2672.

The composition has two mirrors art. FLASH100W and two tops in Noce canaletto L 144 cm, H 12,5 cm art. BANCO154, two sinks in white Flumood art. URNAMOOD. The AYATI tap in the satin finish art. AY921SA and art. AY600SA. The cabinet PANTA REI CENTRO lacquered matt Strada L 72 cm, H 50 cm, D 54 cm, art. PA2672.





La composizione comprende uno specchio art. NEUTROLED90W e uno art. NTKIT50W, rubinetteria AYATI, art. AY301LU da piano e art. AY921LU art. AY600LU, da parete. Top in Flumood Bianco, art. BCS54, con lavabi sopra piano art. SIMPLOTONDO e art. SIMPLO42. Il mobile L 216 cm, H 37,5 cm, P 47 cm, è laccato colore Cipria lucido art. PIM10216.

The composition includes a mirror art. NEUTROLED90W and one mirror art. NTKIT50W, AYATI taps art. AY301LU on the sink and art. AY921LU and art. AY600LU, wall mounted. Top in white Flumood art. BCS54 with top mount sinks art. SIMPLOTONDO and art. SIMPLO42. The cabinet L 216 cm H 37,5 cm D 47 cm is lacquered glossy color Cipria art. PM10216.



Il mobile, L 216 cm, H 37,5 cm, P 54 cm art. PI10216 è laccato Mostarda opaco e corredato di zoccolo H 5 cm, laccato Nero goffrato art. PZ54.

The furniture L 216 cm, H 37,5 cm, D 54 cm, art. PI10216 is lacquered matt Mostarda, has an embossed lacquered Nero plinth H 5 cm art. PZ54.



Pensile con anta a specchio L 162 cm, H 50 cm, P 32 cm, art. SEGRETO, laccato Mostarda opaco; top in Flumood Bianco L 216 cm, H 12,5 cm, P 54 cm, art. BCS54, con lavabo in Flumood Bianco art. RETTOMOOD63 e rubinetteria AYATI in finitura lucida art. AY200LU. Il mobile L 216 cm, H 25 cm, P 54 cm, laccato Ovatta opaco è l'art. PB10216.

Wall cabinet with mirrored front L 162 cm, H 50 cm, D 32 cm, art. SEGRETO, lacquered matt Mostarda; top in white Flumood finish L 216 cm, H 12,5 cm, D 54 cm, art. BCS54 with white Flumood sink art. RETTOMOOD63 and AYATI tap in the polished finish art. AY200LU. The furniture L 216 cm, H 25 cm, D 54 cm, is lacquered matt Ovatta art. PB10216.





La composizione comprende, sei pensili L 72 cm e L 27 cm, H 25 cm, P 14 cm, in vetro extrachiaro con schienale laccato Matita e Grigio fango opaco. Il mobile PANTA REI XL è composto da due basi L 72 cm, art. PA4872 e da un porta lavabo L 72 cm, art. PA4672, la composizione è P 54 cm e H 50 cm, in essenza Noce canaletto. Il top è in Corian, L 216 cm, P 54 cm, art. CR254 con lavabo integrato art. SEGNO72; la rubinetteria è AYATI in finitura satinata art. AY301SA. Lo specchio è L 72 cm, H 90 cm, art. FLASH90W.

The composition includes six wall cabinets L 72 cm and L 27 cm, H 25 cm, D 14 cm in extra clear glass with lacquered back, colors matt Matita and Grigio fango. The cabinet PANTA REI XL is composed of two elements L 72 cm, art. PA4872 and a sink unit L 72 CM, art. PA4672. The composition is D 54 cm and H 50 cm in Noce canaletto. Corian top L 216 cm, D 54 cm, art. CR254 with integrated sink art. SEGNO72; satin AYATI tap art. AY301SA. Mirror L 72 cm, H 90 cm, art. FLASH90W.





La composizione laccata Matita opaco, comprende due pensili con anta a specchio, completi di illuminazione, L 54 cm, H 50,5 cm, P 14,7 cm art. MANTRA150. I due mobili PANTA REI XL sono formati da due basi di L 72 cm art. PA4772 e due porta lavabi L 54 cm, P 40 cm e H 50 cm art. PA4554. I lavabi sono in Flumood Bianco, art. GESTOMOOD54 e la rubinetteria è AYATI in finitura lucida art. AY301LU.

The lacquered composition matt Matita includes two wall cabinets with mirrored door, complete with lighting, L 54 cm, H 50,5 cm, D 14,7 cm art. MANTRA150. The PANTA REI XL furniture are made up of two cabinets L 72 cm art. PA4772 and two sink units L 54 cm, D 40 cm and H 50 cm art. PA4554. Sinks in white Flumood art. GESTOMOOD54 and polished AYATI tap art. AY301LU.



PANTA REI LEGENDA - KEY

Gli elementi di questa collezione sono verniciati internamente ed esternamente.

The elements of this collection are lacquered both internally and externally.

A



Bianco lucido/colorato opaco o gofrato, come da nostro campionario colori

Glossy white/Matt lacquered or embossed, as per our colour samples



D



Colorato lucido/finitura seta, come da nostro campionario colori

Glossy lacquered/Silk finish, as per our colour samples



B



Rovere: sbiancato, naturale castano, moro, grigio, matita, ardesia.

E

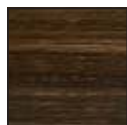

Rovere: thermo.

Noce: canadese, visone, canaletto.

PANTA REI

H 25 - 37,5 - 50

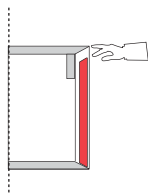

Soluzione 1 cassetto con apertura superiore.

Solution with 1 upper opening drawer.

PANTA REI CENTRO

H 50

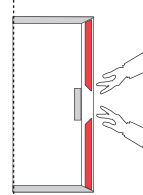
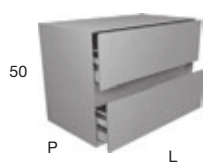

Soluzione 2 cassetti con apertura centrale.

Solution with 2 center opening drawers.

PANTA REI XL

H 37,5 / 50

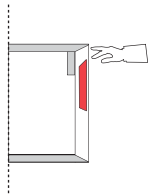
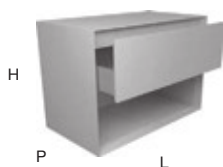

Soluzione 1 cassetto con apertura superiore e 1 vano a giorno.

Solution with 1 upper opening drawer and 1 open compartment.

PANTA REI DOBLE

H 37,5

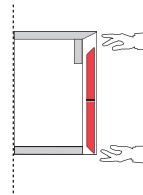
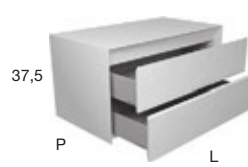

Soluzione 2 cassetti con apertura superiore ed inferiore.

Solution with 2 drawers 1 upper opening and 1 bottom opening.

PANTA REI COMPONENTI - COMPONENTS



H	P	L
25	40	36 - 45 - 54 - 72 - 90 - 108
37,5	47	
50	54	

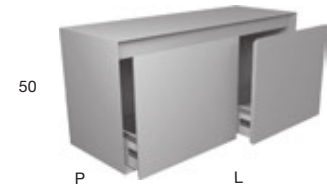

H	P	L
25	40	72 (36+36) - 90 (45+45) - 108 (54+54) - 144 (72+72) - 180 (90+90) - 216 (108+108)
37,5	47	
50	54	

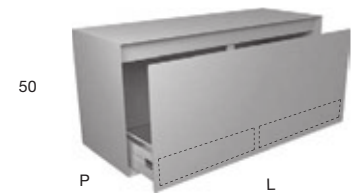
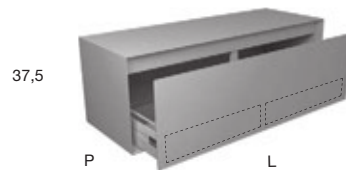

H	P	L
25	40	144 (72+72) / 180 (90+90)
37,5	47	
50	54	



H	P	L
25	40	108 (72+36) / 126 (72+54) / 135 (90+45) / 144 (90+54) / 144 (108+36) / 162 (90+72) / 162 (108+54)
37,5	47	
50	54	

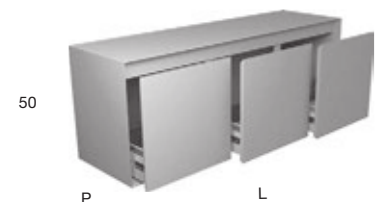

H	P	L
25	40	108 (36+36+36) / 135 (45+45+45) / 162 (54+54+54) / 216 (72+72+72)
37,5	47	
50	54	

PANTA REI COMPONENTI - COMPONENTS

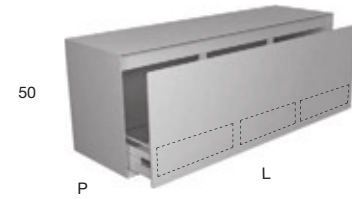
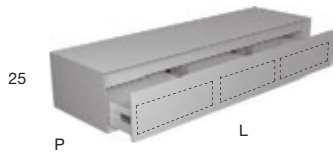

H	P	L
25	40	135 (45+45+45) / 162 (54+54+54)
37,5	47	
50	54	



H	P	L
25	40	144 (72+36+36) / 162 (90+36+36) / 180 (90+45+45) / 180 (108+36+36) / 216 (108+54+54)
37,5	47	
50	54	

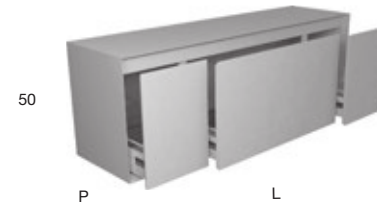

H	P	L
25	40	144 (36+72+36) / 162 (36+90+36) / 180 (45+90+45)
37,5	47	
50	54	



H	P	L
25	40	180 (72+36+72) / 216 (90+36+90)
37,5	47	
50	54	



H	P	L
25	40	180 (72+72+36) / 216 (90+90+36)
37,5	47	
50	54	

PANTA REI

PANTA REI CENTRO COMPONENTI - COMPONENTS

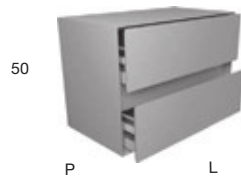

H	P	L
50	40	36 - 45 - 54 - 72 - 90 - 108
	47	
	54	

H	P	L
50	40	72 (36+36) - 90 (45+45) - 108 (54+54) - 144 (72+72) - 180 (90+90) - 216 (108+108)
	47	
	54	

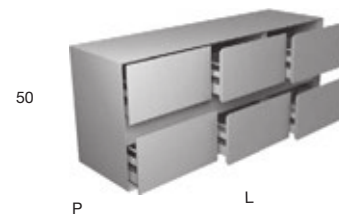

H	P	L
50	40	108 (72+36) - 126 (72+54) - 135 (90+45)
	47	144 (90+54) - 144 (108+36) - 162 (90+72) - 162 (108+54)
	54	

H	P	L
50	40	108 (36+36+36) - 135 (45+45+45) - 162 (54+54+54) - 216 (72+72+72)
	47	
	54	

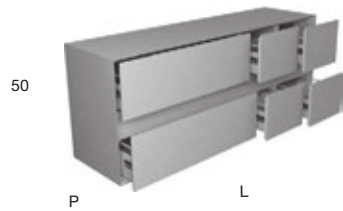

H	P	L
50	40	144 (72+36+36) - 162 (90+36+36) - 180 (90+45+45)
	47	180 (108+36+36) - 216 (108+54+54)
	54	

H	P	L
50	40	144 (36+72+36) - 162 (36+90+36) - 180 (45+90+45)
	47	
	54	

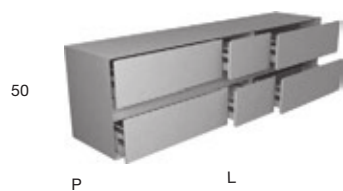

H	P	L
50	40	180 (72+36+72) - 216 (90+36+90)
	47	
	54	

H	P	L
50	40	180 (72+72+36) - 216 (90+90+36)
	47	
	54	



PANTA REI

PANTA REI XL COMPONENTI - COMPONENTS

In fase di ordine indicare il tipo di composizione scegliendo la lettera di riferimento (A,B,C,D,E,F,G), le misure dei componenti e la versione desiderata. Il mobile verrà composto in azienda e arriverà al cliente già montato come da soluzione scelta. Di seguito troverete un esempio esplicativo di come ordinare un mobile appartenente alla soluzione D. Le soluzioni A e B possono essere utilizzate con lavabi a parete, con lavabi da terra, oppure possono essere inseriti singolarmente in spazi living.

Specify at time of order the type of configuration among the proposed solutions (A,B,C,D,E,F,G) together with desired size of units and selected category. The modules will be assembled at the company and will be delivered to the client as per selected configuration. Find below an example of how to order one configuration belonging to solution D. Solution A and B are suitable for wall-mounted sinks, freestanding sinks or can be placed as an independent unit in a living room.

ESEMPIO MOBILE DA ORDINARE | EXAMPLE OF CONFIGURATION TO ORDER

D SOLUZIONE | CONFIGURATION

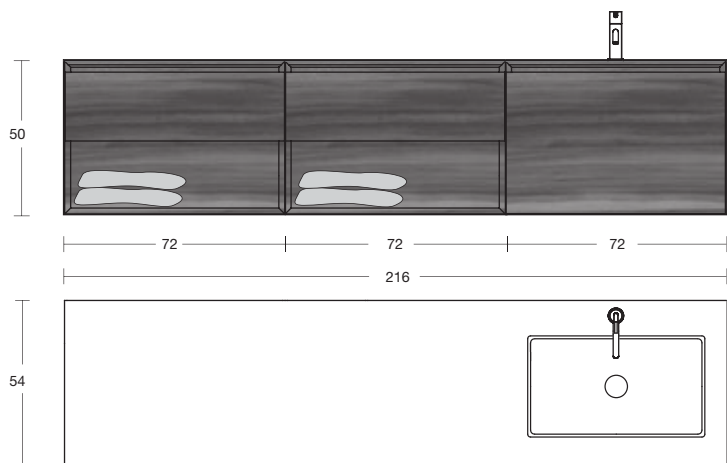

Versione dx - Right version

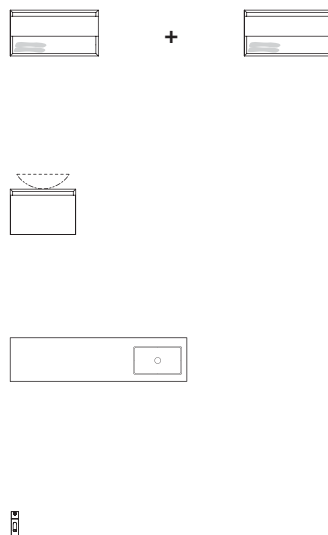

- N° 2 ART. PA4872 L 72
Base con 1 cassetto e 1 vano a giorno
Cabinet with 1 drawer and 1 open compartment
- +
- ART. PA4672 L 72
Portalavabo con 1 cassetto
Sink unit with 1 drawer
- +
- ART. BC254 + ART. NIDO72 L 216
Top con lavabo integrato
Top with integrated sink
- +
- ART. AY301SA/AY301LU
Miscelatore monocomando
Single lever mixer

SOLUZIONI LIVING | LIVING CABINETRY CONFIGURATIONS

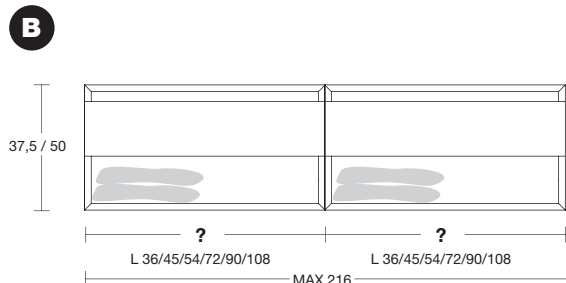
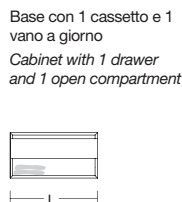
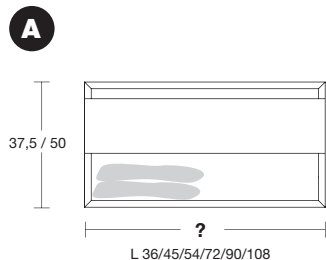

SOLUZIONI CON PORTALAVABO | CONFIGURATIONS WITH SINK UNIT

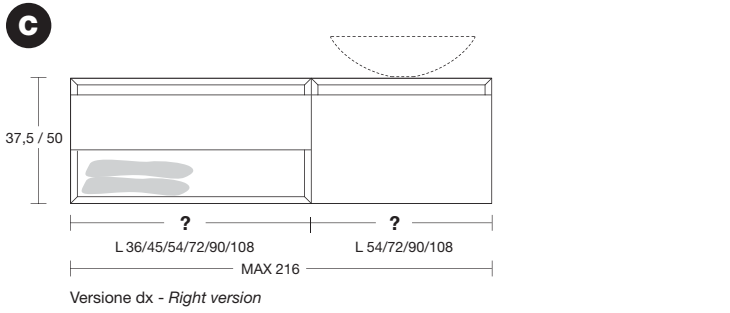

Base con 1 cassetto e 1 vano a giorno
Cabinet with 1 drawer and 1 open compartment



Portalavabo con 1 cassetto
Sink unit with 1 drawer

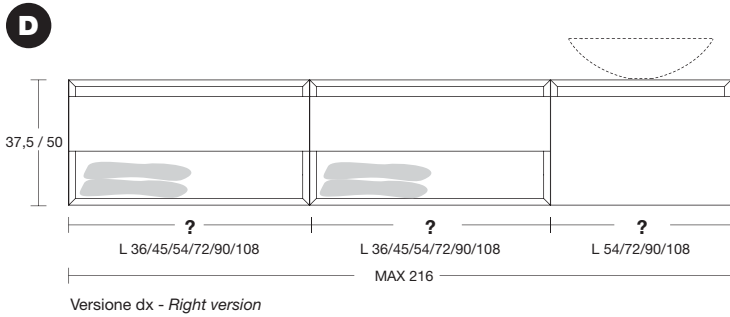

Base con 1 cassetto e 1 vano a giorno
Cabinet with 1 drawer and 1 open compartment



Base con 1 cassetto e 1 vano a giorno
Cabinet with 1 drawer and 1 open compartment



Portalavabo con 1 cassetto
Sink unit with 1 drawer

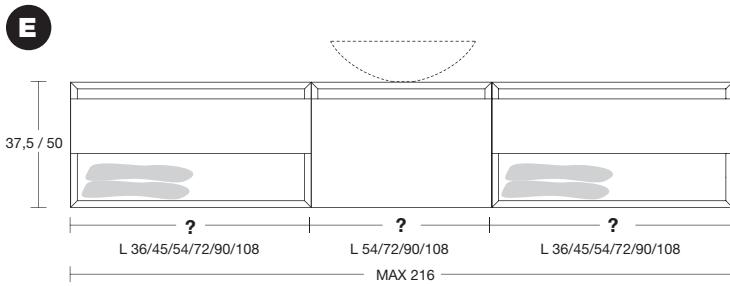
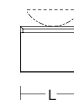

Base con 1 cassetto e 1 vano a giorno
Cabinet with 1 drawer and 1 open compartment



Portalavabo con 1 cassetto
Sink unit with 1 drawer



Base con 1 cassetto e 1 vano a giorno
Cabinet with 1 drawer and 1 open compartment

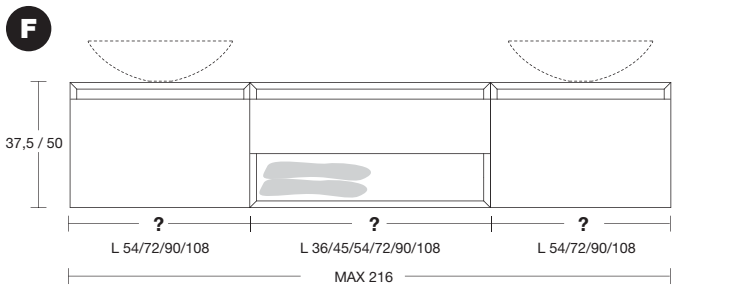

Portalavabo con 1 cassetto
Sink unit with 1 drawer



Base con 1 cassetto e 1 vano a giorno
Cabinet with 1 drawer and 1 open compartment



Portalavabo con 1 cassetto
Sink unit with 1 drawer

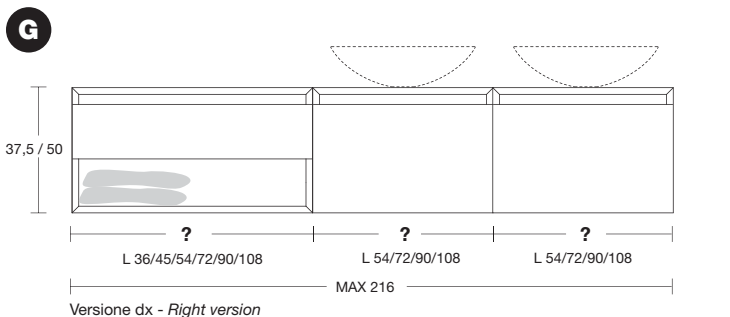

Base con 1 cassetto e 1 vano a giorno
Cabinet with 1 drawer and 1 open compartment



Portalavabo con 1 cassetto
Sink unit with 1 drawer



Portalavabo con 1 cassetto
Sink unit with 1 drawer



PANTA REI DOBLE COMPONENTI - COMPONENTS

In fase di ordine indicare il tipo di composizione scegliendo la lettera di riferimento (A,B,C,D,E,F,G), le misure dei componenti e la versione desiderata. Il mobile verrà composto in azienda e arriverà al cliente già montato come da soluzione scelta. Di seguito troverete un esempio esplicativo di come ordinare un mobile appartenente alla soluzione D. Le soluzioni A e B possono essere utilizzate con lavabi a parete, con lavabi da terra, oppure possono essere inseriti singolarmente in spazi living.

Specify at time of order the type of configuration among the proposed solutions (A,B,C,D,E,F,G) together with desired size of units and selected category. The modules will be assembled at the company and will be delivered to the client as per selected configuration. Find below an example of how to order one configuration belonging to solution D. Solution A and B are suitable for wall-mounted sinks, freestanding sinks or can be placed as an independent unit in a living room.

ESEMPIO MOBILE DA ORDINARE | EXAMPLE OF CONFIGURATION TO ORDER

D SOLUZIONE | CONFIGURATION

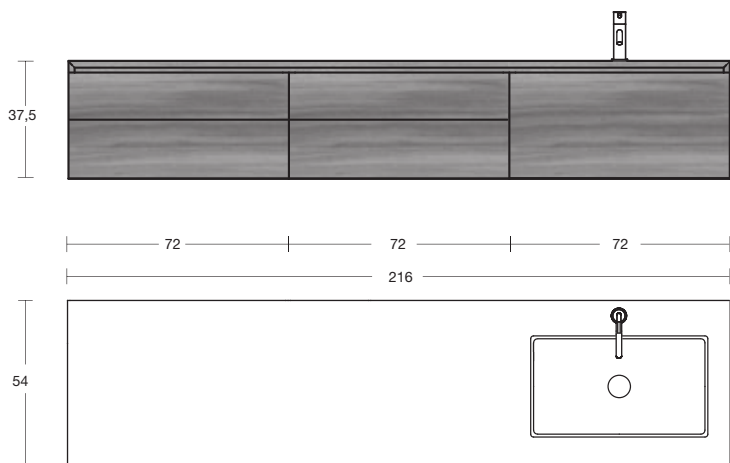

Versione dx - Right version

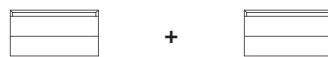

+



N° 2 ART. PA4872 L 72

Base con 2 cassetti
Double drawer cabinet

+

ART. PI5472 L 72

Portalavabo con 1 cassetto
Sink unit with 1 drawer

+

ART. BC254 + ART. NIDO72 L 216

Top con lavabo integrato
Top with integrated sink

+

ART. AY301SA/AY301LU

Miscelatore monocomando
Single lever mixer

SOLUZIONI LIVING | LIVING CABINETRY CONFIGURATIONS

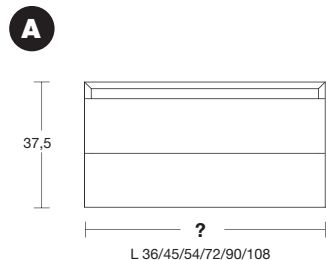

Base con 2 cassetti
Double drawer cabinet

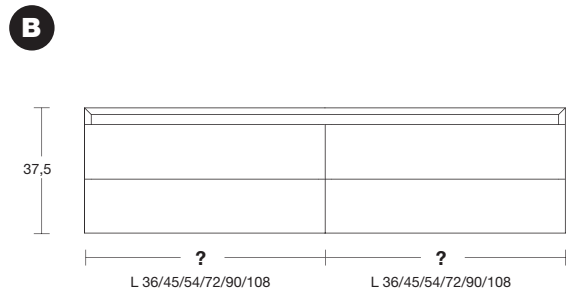

Base con 2 cassetti
Double drawer cabinet



+

Base con 2 cassetti
Double drawer cabinet



SOLUZIONI CON PORTALAVABO | CONFIGURATIONS WITH SINK UNIT

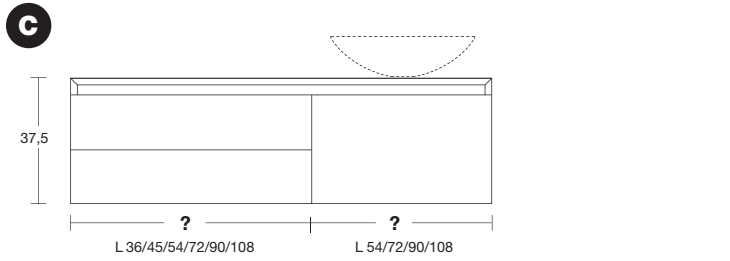

Base con 2 cassetti
Double drawer cabinet

Portalavabo con 1 cassetto
Sink unit with 1 drawer

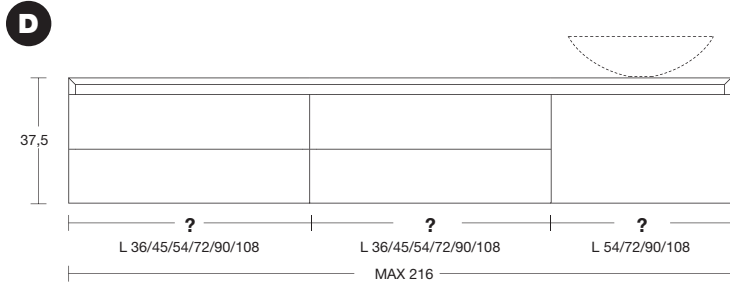

Base con 2 cassetti
Double drawer cabinet

Base con 2 cassetti
Double drawer cabinet

Portalavabo con 1 cassetto
Sink unit with 1 drawer



Versione dx - Right version

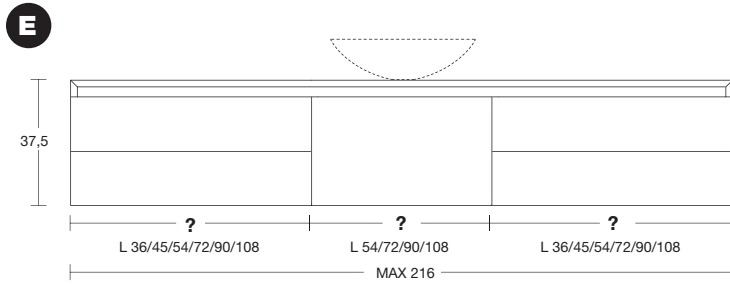

Base con 2 cassetti
Double drawer cabinet

Portalavabo con 1 cassetto
Sink unit with 1 drawer

Base con 2 cassetti
Double drawer cabinet

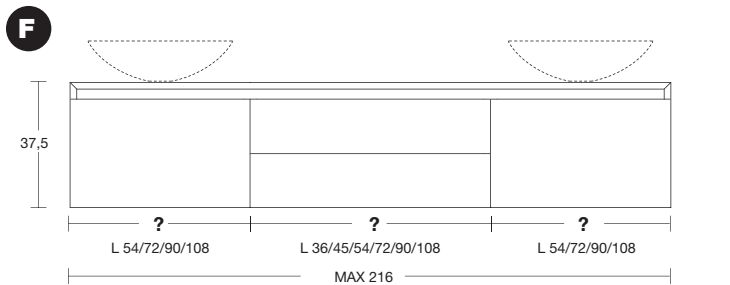
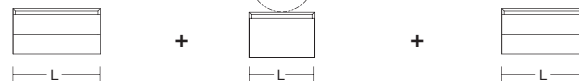

Portalavabo con 1 cassetto
Sink unit with 1 drawer

Base con 2 cassetti
Double drawer cabinet

Portalavabo con 1 cassetto
Sink unit with 1 drawer

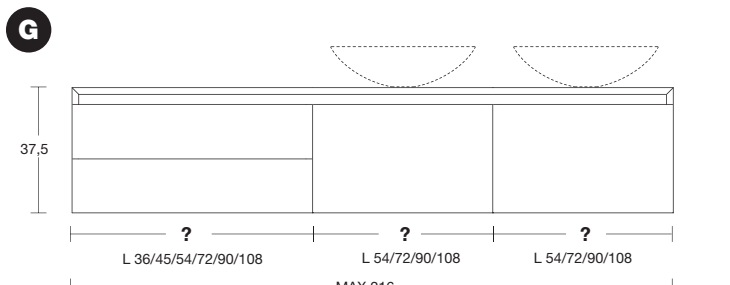

Base con 2 cassetti
Double drawer cabinet

Portalavabo con 1 cassetto
Sink unit with 1 drawer

Portalavabo con 1 cassetto
Sink unit with 1 drawer

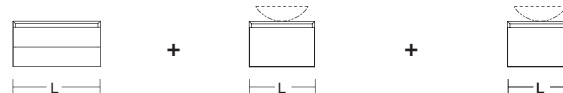

Versione dx - Right version

PANTA REI XL

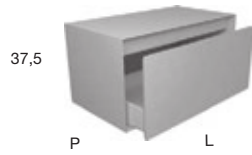

H	P	L
37,5	40	54 - 72 - 90 - 108
	47	
	54	

H	P	L
50	40	54 - 72 - 90 - 108
	47	
	54	

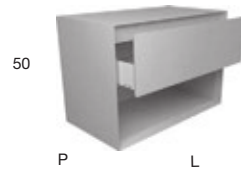

H	P	L
37,5	40	36 - 45 - 54 - 72 - 90 - 108
	47	
	54	

H	P	L
50	40	36 - 45 - 54 - 72 - 90 - 108
	47	
	54	

PANTA REI DOBLE

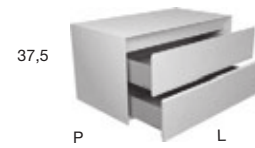
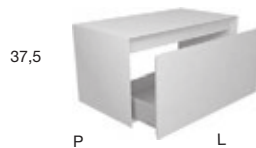

H	P	L
37,5	40	54 - 72 - 90 - 108
	47	
	54	

H	P	L
37,5	40	36 - 45 - 54 - 72 - 90 - 108
	47	
	54	

PANTA REI PENSILI E COLONNE - WALL CABINETS AND HIGH CABINETS

Pensile dx o sx con 1 anta e 2 ripiani interni.
 Right or left single door wall cabinet with 2 internal shelves.

Pensile dx o sx con 1 anta e 2 ripiani interni.
 Right or left single door wall cabinet with 2 internal shelves.

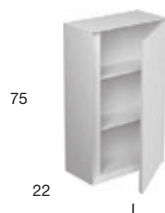

H P L
 75 22 27 - 36 - 45

H P L
 100 22 27 - 36 - 45

Colonna dx o sx con 1 anta e 3 ripiani interni.
 Right or left single door high cabinet with 3 internal shelves.

Colonna dx o sx con 1 anta e 4 ripiani interni.
 Right or left single door high cabinet with 4 internal shelves.

Colonna dx o sx con 1 anta e 4 ripiani interni.
 Right or left single door high cabinet with 4 internal shelves.



H P L
 125 22 27 - 36 - 45

H P L
 150 22 27 - 36 - 45

H P L
 175 22 27 - 36 - 45

Colonna dx o sx con 1 anta, 3 ripiani interni e 1 cassetto Art. SLIM.
 Right or left single door high cabinet, 3 internal shelves and 1 drawer Art. SLIM.

Colonna dx o sx con 2 ante e 4 ripiani interni.
 Right or left double door high cabinet with 4 internal shelves.

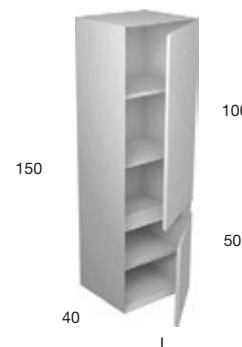

H P L
 150 40 36 - 45

H P L
 150 40 36 - 45

PENSILI | WALL CABINETS

COLONNE | HIGH CABINETS

PANTA REI

COLONNE | HIGH CABINETS

PIANA

2011

design_Nevio Tellatin

Semplice nella sua eleganza, raffinata nella sua essenzialità, esclusiva e personalizzabile grazie alle molteplici possibilità di combinazione.

Piana è una delle collezioni che esprime al meglio la capacità di antoniolupi di rendere sartoriale ogni progetto, di realizzare ogni composizione come fosse un vestito su misura per dimensioni, colori e finiture.

Un'immagine fresca e pulita che nasconde una sapienza produttiva e una qualità dei materiali che garantiscono estetica e gradevolezza ad ogni livello.

Oggi la collezione Piana "tocca terra" andando oltre le versioni sospese che da sempre hanno identificato questa proposta e ne hanno caratterizzato l'immagine.

Un'evoluzione che dona un aspetto diverso alla microarchitettura domestica, che ridefinisce gerarchie e rapporti dimensionali all'interno dell'ambiente bagno, che delinea nuovi monoblocchi componibili in grado di arredare lo spazio donandogli personalità e carattere.

Una proposta che amplifica la funzionalità dei volumi aumentandone di fatto la capacità contenitiva e razionalizzando lo spazio per ospitare tutto quanto necessario allo svolgimento delle operazioni quotidiane nell'area lavabo.

Piana è ora anche disponibile nella versione da terra abbinabile a lavabo sopra-piano, lavabo integrato o sottopiano, in diverse combinazioni componibili tra ante e cassetti per soddisfare le diverse esigenze.

Simple in its elegance, refined in its essentiality, exclusive and customizable thanks to the multiple possibilities of combinations.

Piana is one of the collections that best expresses the ability of antoniolupi to make each project tailor-made, to create each composition as if it were a tailored suit for dimensions, colors and finishes.

A fresh and clean image that hides a productive wisdom and a quality of materials that guarantee aesthetics and amenity at every level.

Today the Piana collection "touches the ground" going beyond the suspended versions that have always identified this proposal and characterized its image.

An evolution that gives a different aspect to domestic micro-architecture, which redefines hierarchies and dimensional relationships within the bathroom, outlining new modular mono-blocks able to furnish the space giving it personality and character.

A proposal that amplifies the functionality of the volumes, effectively increasing the storage capacity and rationalizing the space to accommodate everything necessary for daily operations in the bathroom area.

Piana is also now available in the freestanding version combined with a top mount sink, integrated or undermount sink, with different modular combinations between doors and drawers to meet different needs.



PIANA

PIANA FINITURE - FINISHES

A



Bianco lucido/colorato opaco o gofrato, come da nostro campionario colori



Glossy white/Matt lacquered or embossed, as per our colour samples

D



Colorato lucido/finitura seta, come da nostro campionario colori



Glossy lacquered/Silk finish, as per our colour samples

O

Venatura verticale / Vertical grain

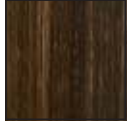

Rovere: sbiancato, naturale castano, moro, grigio, matita, ardesia, thermo.

Noce: canadese, visone, canaletto.

ESEMPLI ALTEZZE MOBILI H 65 - 73 - 83 | EXAMPLES OF FURNITURE HEIGHTS H 65 - 73 - 83

H 65

Versione sospesa.
Suspended version.

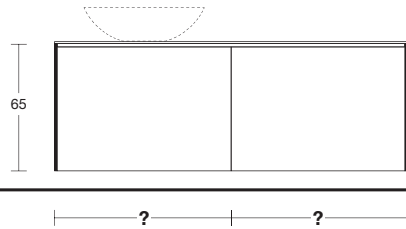

Con piedini H 3 cm.
With feet H 3 cm.

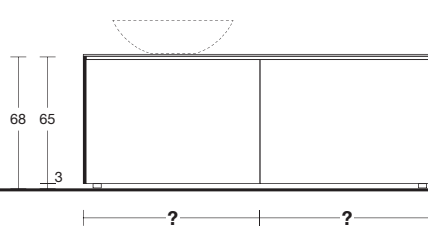

Con zoccolo H 10 cm.
With plinth H 10 cm.

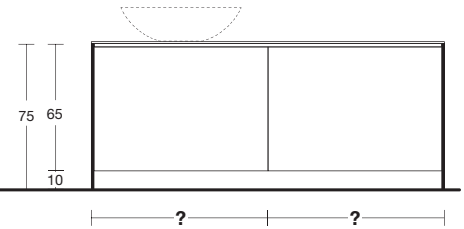

H 73

Versione sospesa.
Suspended version.

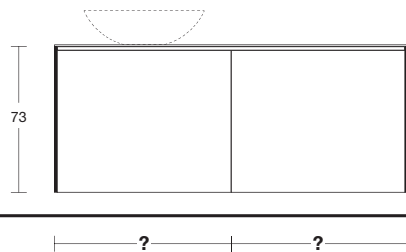

Con piedini H 3 cm.
With feet H 3 cm.

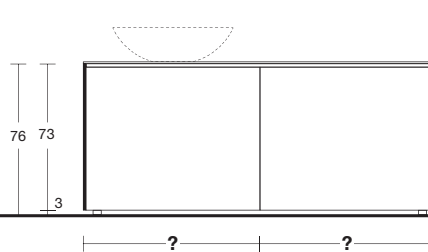

Con zoccolo H 10 cm.
With plinth H 10 cm.

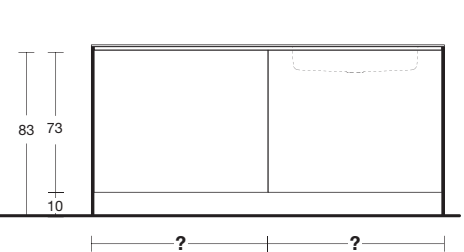

H 83

Versione sospesa.
Suspended version.

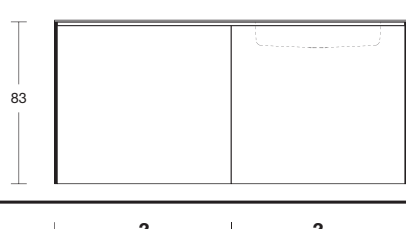

Con piedini H 3 cm.
With feet H 3 cm.

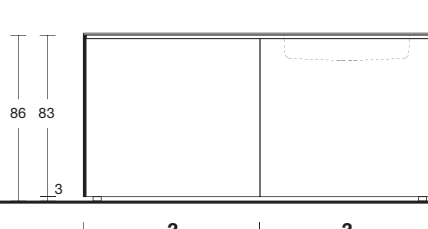



PIANA

PIANA COMPONENTI - COMPONENTS

ACCESSORI | ACCESSORIES

art. PIEDINO

Set di n°4 piedini regolabili, per ogni elemento.
Utilizzare sempre con art. ZOCCOLO.

*Set of 4 regulating feet for each element.
Use always with art. ZOCCOLO.*



H
10

art. ZOCCOLO

Zoccolo in alluminio.
Utilizzare sempre con art. PIEDINO.

*Aluminum plinth.
Use always with art. PIEDINO.*



H L
10 da / from 27 a / to 272

art. PICCO

Set di n°4 piedini con livellatore, per ogni elemento. Non necessita di zoccolo.

*Set of 4 regulating feet for each element.
Does not need a plinth.*



H Ø
3 5

FIANCHI | SIDES

Fianco da aggiungere a dx e sx della composizione, formata da uno o più componenti.

Side panel to add on the right and left of each composition made up of one or more components.

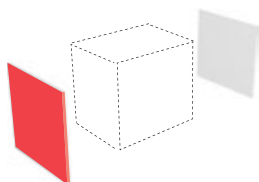

H P
65 40
73 47
75 54
83

Fianco da aggiungere a dx e sx della composizione, formata da uno o più componenti, con top Art. PONTE40, Art. PONTE47, Art. PONTE54, Art. PONTE140, Art. PONTE147 e Art. PONTE154.

Side panel to add on the right and left of the final composition made of one or more elements with top Art. PONTE40, Art. PONTE47, Art. PONTE54, Art. PONTE140, Art. PONTE147 and Art. PONTE154.



H Per mobili - For cabinets H P
62,5 65 40
70,5 73 47
72,5 75 54
80,5 83

PORTA LAVABI | SINK UNITS

Porta lavabo dx o sx con 1 anta e 1 ripiano interno.

Right or left single door sink unit with 1 internal shelf.

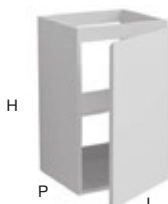

H P L
65 40 36 - 45
73 47
83 54

Porta lavabo con 2 ante e 1 ripiano interno.

Double door sink unit with 1 internal shelf.

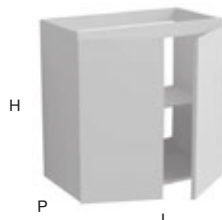

H P L
65 40 72 - 90
73 47
83 54

Porta lavabo con 1 cassetto Art. SLIM.
Large drawer sink unit Art. SLIM.

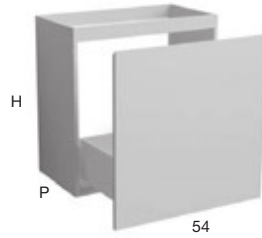

H	P	L
65	40	54
73	47	
83	54	

Porta lavabo con fascia centrale, superiore e 2 cassetti Art. SLIM di cui 1 sagomato internamente per sifone.
Double drawer sink unit Art. SLIM, one of which internally shaped for siphon, middle and upper front panel.

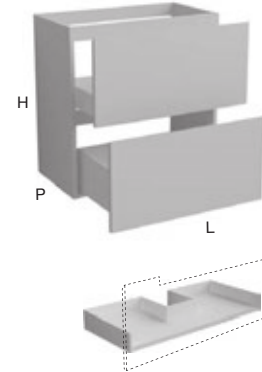

H	P	L
65	40	54 - 72 - 90 - 108
73	47	
83	54	

PORTA LAVABI | SINK UNITS

Base dx o sx con 1 anta e 1 ripiano interno.
Right or left single door cabinet with 1 inner shelf.

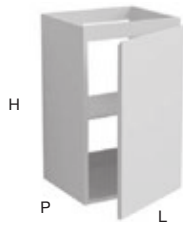

H	P	L
65	40	27 - 36 - 45
73	47	
83	54	

Base con 2 ante e 1 ripiano interno.
Double door cabinet with 1 internal shelf.

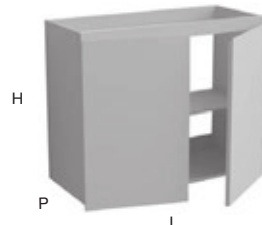

H	P	L
65	40	72 - 90
73	47	
83	54	

Base con 1 cassetto Art. SLIM.
Single drawer cabinet Art. SLIM.

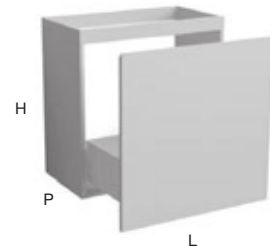

H	P	L
65	40	36 - 45
73	47	
83	54	

BASI | CABINETS

PIANA

Base con fascia centrale, superiore e 2 cassetti Art. SLIM.
Cabinet with middle and upper front panel and 2 drawers Art. SLIM.

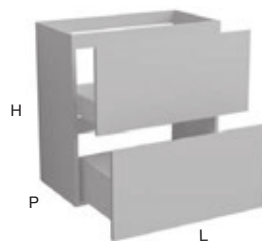

H	P	L
65	40	27 - 36 - 45 - 54 - 72 - 90 - 108
73	47	
83	54	

Base con fascia centrale, superiore e 3 cassetti Art. SLIM.
Cabinet with middle and upper front panel and 3 drawers Art. SLIM.

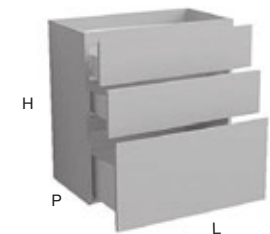

H	P	L
65	40	27 - 36 - 45 - 54 - 72 - 90 - 108
73	47	
83	54	

BASI | CABINETS

Piana H 73 + 3 = H 76 cm P 47 cm



La composizione è composta da specchi su misura illuminati da tre faretti art. ZENITLED, la rubinetteria è AYATI art. AY921SA e art. AY600SA, in acciaio satinato.

Il mobile è formato da due porta lavabi art. ILTM5472 L 72 cm, una base art. IBTM5236 destra di L 36 cm e due basi art. IBTM2072 L 72 cm; tutti gli elementi sono P 47 cm, H 73 cm, laccati Anatra gofrato e montano i piedi regolabili art. PICCO.

Il top è in Colormood Ramerino, art. BC147, con misure su richiesta, L 324 cm P 47 cm Sp. 1,2 cm, con lavabi da appoggio art. RIM54 in Flumood Bianco. Tappeto della collezione GEOMETRIE VOLANTI art. GV59, L 400 cm P 100 cm.



The composition is made up of custom-made mirrors illuminated by three spotlights art. ZENITLED, the taps are from the AYATI series art. AY921SA and art. AY600SA, in satin steel finish.

The cabinet consists of two sink units art. ILTM5472 L 72 cm, cabinet on the right art. IBTM5236 L 36 cm and two cabinets art. IBTM2072 L 72 cm; all the elements are D 47 cm, H 73 cm, embossed lacquered Anatra and fitted with adjustable feet art. PICCO. The top is in Colormood color Ramerino, art. BC147, with measurements on request, L 324 cm D 47 cm and 1,2 cm thick, with countertop sinks art. RIM54 in white Flumood. Carpet of the collection GEOMETRIE VOLANTI art. GV59, L 400 cm D 100 cm.





Nella foto in alto e a sinistra, top in Colormood colore Ramerino con lavabo da appoggio art. RIM54.
Rubinetteria AYATI, art. AY600SA e art. AY921SA finitura acciaio satinato.

*In the photo above and on the left, top in Colormood color Ramerino with countertop sink art. RIM54.
AYATI taps, art. AY600SA and art. AY921SA in satin steel finish.*

Piana H 73 + 10 = H 83 cm P 47 cm



Questa composizione comprende lo specchio retroilluminato art. CIRCUS1108W, Ø 108 cm con lampada LUCENTE, L 108 cm; rubinetteria INDIGO art. ND301 finitura grafite.

Il mobile, L 182,4 cm P 47 cm H 83 cm, è composto da un porta lavabo art. ILM5490, una base art. IBTM5490, due fianchi art. IFO47, zoccolo in alluminio verniciato Matita gofrato; struttura in Skin cenere, ante e fianchi verniciati Matita gofrato. Il top, in Flumood colore Bianco art. BC147 L 182,4 cm P 47 cm Sp 1,2 cm, ospita il lavabo integrato art. BASICO47.

Tappeto della collezione GEOMETRIE VOLANTI art. GV642 L 300 cm P 200 cm.



This composition includes the backlit mirror art. CIRCUS1108W, Ø 108 cm with LUCENTE lamp, L 108 cm; INDIGO tap art. ND301 graphite finish. The cabinet, L 182,4 cm D 47 cm H 83 cm, is made up of a sink unit art. ILTM5490, a cabinet art. IBTM5490, two sides art. IFO47, aluminum plinth embossed lacquered Matita; structure in Skin cenere, fronts and sides embossed lacquered Matita. The top, in white Flumood art. BC147 L 182,4 cm D 47 cm and 1,2 cm thick, houses the integrated sink art. BASICO 47. Carpet of the GEOMETRIE VOLANTI collection art. GV642 L 300 cm D 200 cm.





Nella foto a sinistra, Il top, in Flumood colore Bianco art. BC147 L 182,4 cm P 47 cm Sp 1,2 cm, con il lavabo integrato art. BASICO47.

In the photo on the left, the top is in white Flumood art. BC147 L 182,4 cm D 47 cm and 1,2 cm thick, with integrated sink art. BASICO 47.





PIANA

Piana H 73 + 10 = H 83 cm P 47 cm





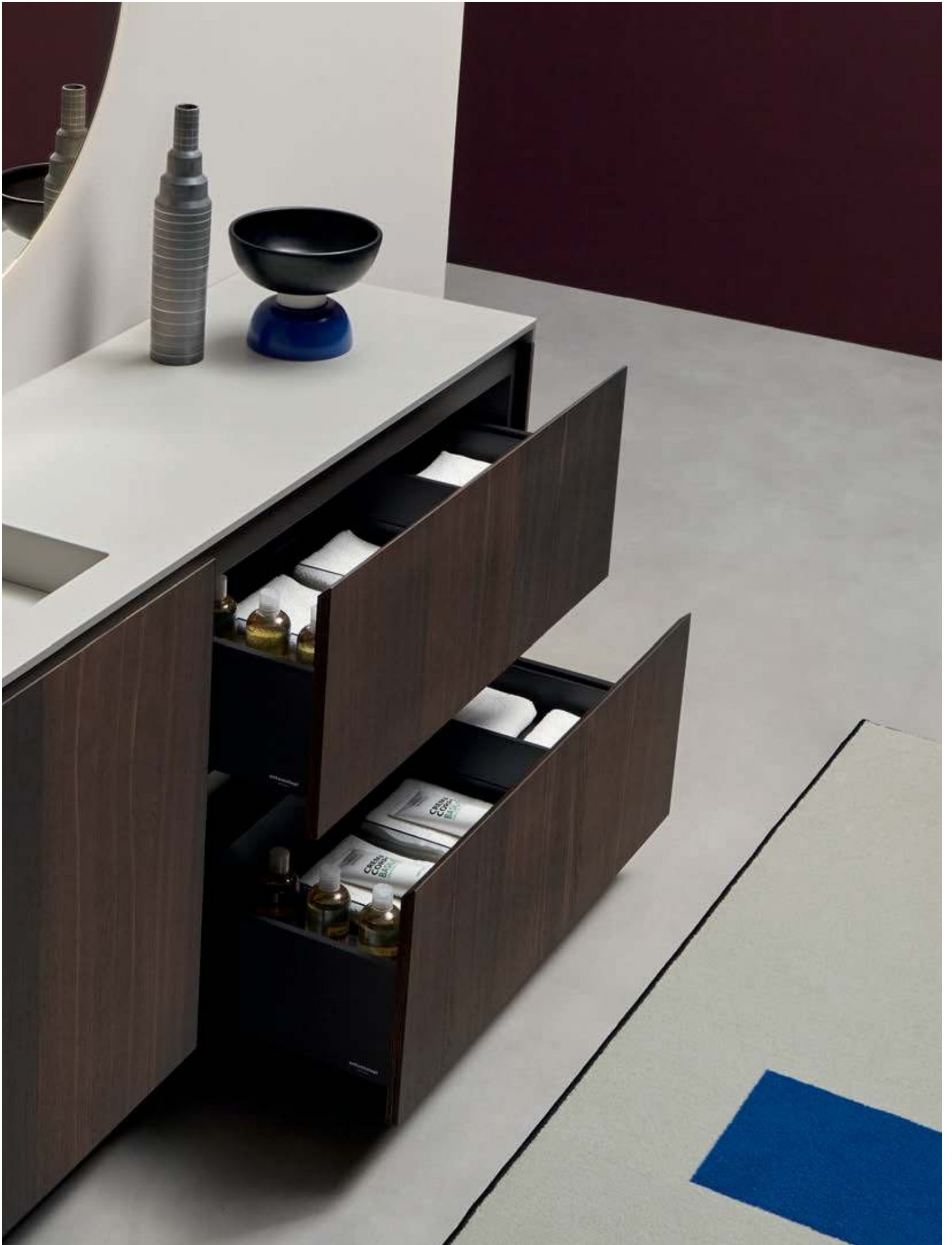



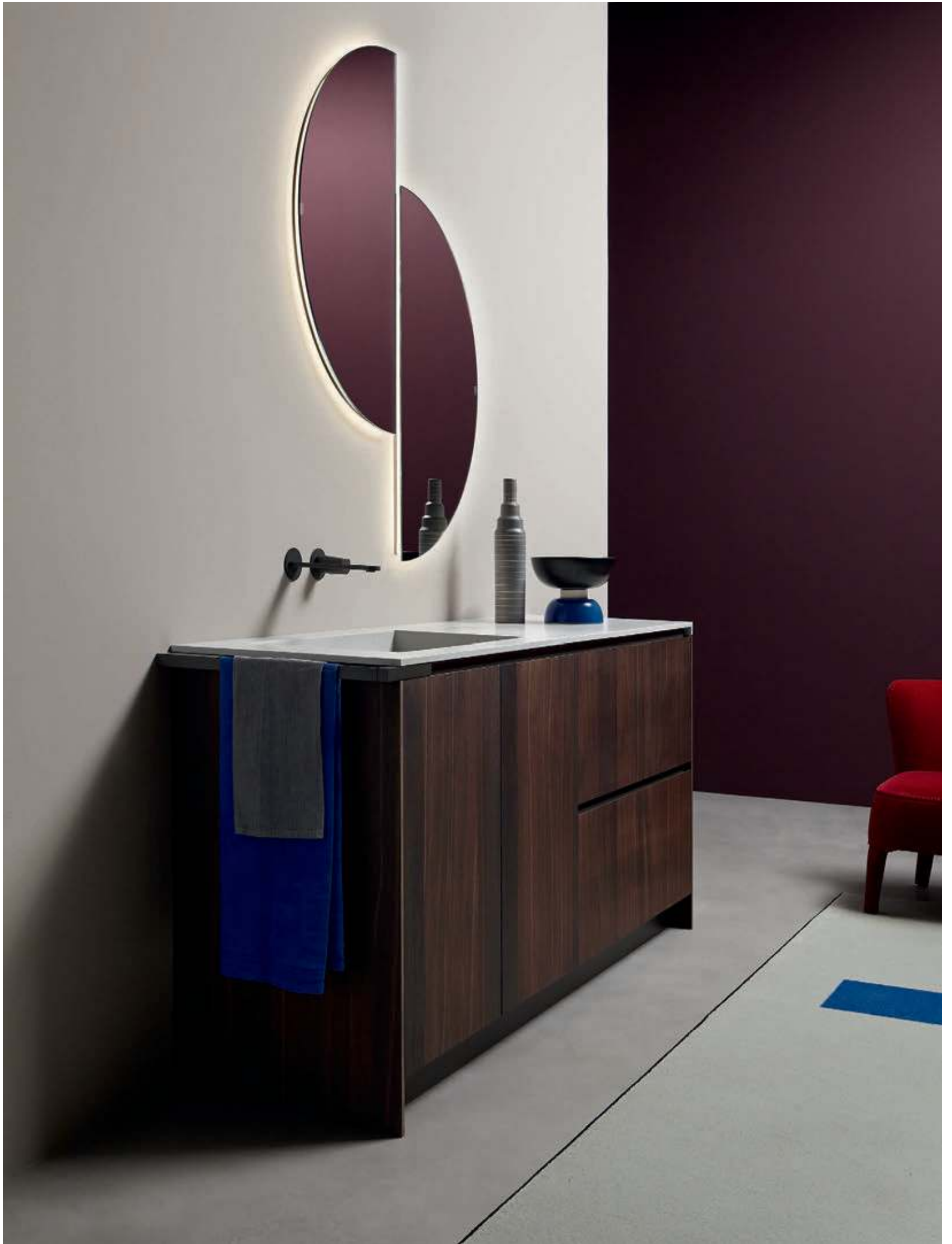



PIANA

Questa composizione comprende due specchi retroilluminati SPICCHIO art. SPICCHIO90W, H 90 cm L 45 cm, rubinetteria INDIGO art. ND921 e art. ND601, finitura grafite. Il mobile, L 182,4 cm P 47 cm, H 83 cm, è composto da un porta lavabo art. ILTM5490, una base art. IBTM890, due fianchi art. IFO47 e art. IFRO47, struttura in Skin cenere, ante e fianchi Rovere thermo, mentre lo zoccolo in alluminio art. ZOCCOLO è in finitura Skin cenere. Il top in Flumood colore Serena art. PONTE147 L 182,4 cm P 47 cm Sp 1,2 cm è completo di portasalviette integrato in finitura Skin cenere e di lavabo integrato art. PODIO90 con copripiletta art. PIANETTO5.

This composition includes two backlit SPICCHIO mirrors art. SPICCHIO90W, H 90 cm L 45 cm, INDIGO taps art. ND921 and art. ND601, graphite finish. The furniture, L 182,4 cm D 47 cm, H 83 cm, is made up of a sink unit art. ILTM5490, a cabinet art. IBTM890, two sides art. IFO47 and art. IFRO47, structure in Skin cenere, fronts and sides in Rovere thermo, while the aluminum plinth art. ZOCCOLO is in Skin cenere. The top is in Flumood color Serena art. PONTE147 L 182,4 cm D 47 cm and 1,2 cm thick, complete with integrated towel holder in Skin cenere and integrated sink art. PODIO90 with cover art. PIANETTO 5.

Piana H 83 + 3 = H 86 cm P 40 cm



Questa composizione comprende due specchi retroilluminati art. USB50108W e art. USB40108W, H 108 cm L 50 cm e rubinetteria INDIGO in finitura grafite. I due mobili di L 110,4 cm P 40 cm H 83 cm sono composti da un porta lavabo art. ILO5372, una base destra art. IBO5136 e due fianchi art. IFO40 e art. IFRO40; la struttura è in Skin cenere, ante e fianchi in Noce canadese. Porta lavabo e basi montano piedi art. PICCO.

Il top in Flumood colore Falena art. PONTE140 L 110,4 cm P 40 cm Sp 1,2 cm è completo di portasalviette integrato finitura Skin cenere, i pensili art. ICE4 L 27 cm H 25 cm, con schienale Ovatta gofrato e art. ICE6 L 72 cm H 25 cm con schienale Anatra gofrato, entrambi con vetro bronzo; portasalviette art. RETTA4108 verniciato Anatra gofrato. Mensola da incasso a parete con struttura in alluminio bianco art. OMBRAL, L 270 cm, con misure su richiesta, con portasalviette art. OMBRAP54. Vasca art.ECLIPSE in Cristalplant e rubinetteria INDIGO art. ND903 finitura grafite. Tappeti collezione GEOMETRIE VOLANTI art. GV626 L 250 cm P 200 cm.



This composition includes two backlit mirrors art. USB50108W and art. USB40108W, H 108 cm L 50 cm, INDIGO taps in a graphite finish. The two furniture units of L 110,4 cm D 40 cm H 83 cm are composed of a sink unit art. ILO5372, a right cabinet art. IBO5136 and two sides art. IFO40 and art. IFRO40; the structure is in Skin cenere, fronts and sides in Noce canadese. Sink units and cabinets mount feet art. PICCO. The top is in Flumood color Falena art. PONTE140 L 110,4 cm D 40 cm and 1,2 cm thick is complete with integrated towel holder in Skin cenere, wall units art. ICE4 L 27 cm H 25 cm, with back lacquered embossed Ovatta and art. ICE6 L 72 cm H 25 cm lacquered embossed Anatra, both with bronze glass; towel holder art. RETTA4108 lacquered embossed Anatra. Recessed wall shelf with white aluminum structure art. OMBRAL, L 270 cm, measurements on request, with towel holder art. OMBRAP54. Bathtub art. ECLIPSE in Cristalplant and INDIGO tap art. ND903 graphite finish. Carpet from the GEOMETRIE VOLANTI collection art. GV626 L 250 cm D 200 cm.





PIANA

Piana H 83 + 3 = H 86 cm P 40 cm



Nella foto in alto top in Flumood colore Falena art. PONTE140 L 110,4 cm P 40 cm Sp 1,2 cm, completo di portasalviette integrato finitura Skin cenere. Il top inoltre, ospita il lavabo integrato art. GRAFFIO4072 in Flumood colore Falena, con rubinetteria INDIGO finitura grafite art. ND301.

In the photo above, top in Flumood color Falena art. PONTE140 L 110,4 cm D 40 cm and 1,2 cm thick, complete with integrated towel holder in Skin cenere. The top also houses the integrated sink art. GRAFFIO4072 in Flumood color Falena, INDIGO tap art. ND301 in graphite finish.



Piana H 83 + 3 = H 86 cm P 40 cm



Nella foto a destra top in Flumood colore Falena art. PONTE140 L 110,4 cm P 40 cm Sp 1,2 cm, completo di portasalviette integrato finitura Skin cenere, con lavabo integrato art. NIDO472. La rubinetteria è INDIGO finitura graphite.

In the photo on the right top in Flumood color Falena art. PONTE140 L 110,4 cm D 40 cm and 1,2 cm thick, complete with integrated towel holder in Skin cenere, with integrated sink art. NIDO472. INDIGO tap in graphite finish.



PIANA

Piana H 83 + 3 = H 86 cm P 47 cm

“TONO SU TONO”

“TONE ON TONE”

Una perfetta integrazione cromatica per un total look assoluto dell'ambiente bagno, un “velo” di colore che ricopre in modo uniforme tutti gli elementi, per esprimere al meglio uno stile e un carattere identitario. Grazie al Colormood il bagno antoniolupi si tinge di colore in tutti i suoi protagonisti più significativi, costruisce un senso di appartenenza che deriva da una coerenza estetica che coinvolge volumi scultorei e articolati ma anche forme semplici e accessori complementari.

Dai top dei mobili ai fianchi dei contenitori, dalle vasche freestanding ai lavabi di diversa tipologia, dai soffioni al radiatore BIT, dalle piantane alle manopole del rubinetto Indigo, dalle barre portasalviette ai profili di alcune collezioni di mobili. Un'uniformità estetica caratterizzata da una finitura opaca e morbida al tatto, che semplifica la lettura dei volumi, che regolarizza le linee e definisce le dimensioni, che mette in risalto quelle proporzioni che nelle collezioni di antoniolupi trovano un equilibrio assoluto. Una gamma colori che consente un'ampia scelta e permette di instaurare un dialogo con gli altri materiali e finiture presenti nell'ambiente bagno, come le texture uniche dei legni, i riflessi dei metalli e del vetro che giocano con la luce, le venature irripetibili delle pietre, l'omogeneità assoluta dei solid surfaces.

A perfect chromatic integration for an absolute total look of the bathroom, a “veil” of color that uniformly covers all the elements, to best express a style and an identity. Thanks to Colormood, the antoniolupi bathroom is tinged with color in all its most significant protagonists, building a sense of belonging that derives from an aesthetic coherence that involves sculptural and arctic volumes but also simple shapes and complementary accessories.

From the tops of the furniture to the sides of the cabinets, from the freestanding bathtubs to the various types of sinks, from the showerheads to the BIT radiators, from the freestanding accessories to the knobs of the Indigo taps, from the towel rails to the profiles of some of the furniture collections. A uniform consistency characterized by a matt finish that is soft to the touch and simplifies the reading of volumes, defining the lines and dimensions that highlights proportions that find an absolute balance in the antoniolupi collections. A range of colors that allows a wide choice and allows you to establish a dialogue with the other materials and finishes present in the bathroom, such as the unique textures of the woods, the light reflections of the metals and glass, the unrepeatable veins of the stones, the absolute homogeneity of solid surfaces.



PIANA



“TONO SU TONO”

“TONE ON TONE”



PIANA

Questa composizione comprende uno specchio retroilluminato art. USB50108W, H 108 cm L 50 cm, rubinetteria INDIGO_COLORS art. ND301SA finitura acciaio satinato con manopola verniciata Ramerino opaco art. MN8124. Il mobile, verniciato seta Ramerino, è composto da un porta lavabo art. ILOM5472, una base art. IBOM5472 e da due fianchi art. IFO47 e art. IFRO47; tutta la composizione monta i piedini regolabili art. PICCO. Il top in Colormood Ramerino, art. PONTE147 L 146,4 cm P 47 cm Sp 1,2 cm, è completo di portasalviette integrato verniciato Ramerino e ospita il lavabo integrato art. BASICO47. La coppia di bicchieri art. PERCEZIONE completa la composizione. Carta da parati della collezione TRALERIGHE art. Q2N. Tappeto della collezione TRAMATO art. TR651 L 240 cm P 120 cm.

This composition is made up of a backlit mirror art. USB50108W, H 108 cm L 50 cm, INDIGO_COLORS tap art. ND301SA in satin steel with knob lacquered matt Ramerino art. MN8124. The cabinet lacquered RAMERINO seta has a sink unit art. ILOM5472 and a cabinet art. IBOM5472, two finishing panels art. IFO47 and art. IFRO47; regulating feet throughout art. PICCO. The top is in Colormood Ramerino art. PONTE147 L 146,4 cm D 47 cm 1,2 cm thick and includes towel rail lacquered Ramerino as well as an integrated sink art. BASICO47. Pair of glasses art. PERCEZIONE completes the composition. Wallpaper TRALERIGHE art. Q2N and carpet TRAMATO art. TR651 L 240 cm D 120 cm.



“TONO SU TONO”

“TONE ON TONE”



“TONO SU TONO”

“TONE ON TONE”



Per composizioni con misure superiori a 270 cm le venature dei frontali sono verticali.
Su richiesta è possibile realizzarle anche per misure inferiori.

For compositions greater than 270 cm L the front grain will be vertical. On request it is possible to have vertical grain on smaller compositions.



PIANA

Questa composizione comprende due specchi retroilluminati: un art. SUPERLUNA90W Ø 90 cm e un art. CIRCUS90W Ø 90 cm; rubinetteria INDIGO art. ND301GR, finitura grafite.

Il mobile, L 290,4 cm P 47 cm H 37,5 cm, è composto da due porta lavabi art. ILIM272, due basi art. IBIM272, un fianco art. IFRI47 ed un fianco art. IFI47; fascia frontale e fianchi sono laccati Basalto seta, ante in Noce canaletto. Il top in Colormood colore Basalto art. PONTE147, L 290,4 cm P 47 cm sp. 1,2, con misure su richiesta, è completo di portasalviette integrato laccato Basalto e di due lavabi integrati art. BASICO47. A parete pensile a giorno art. ICE6, L 72 cm H 25 cm P 14 cm, vetro fumè e schienale verniciato Basalto goffrato. La composizione si completa di optional: illuminazione a led interna ed esterna, attrezzatura interna per cassetti STRATO. Carta da parati TRALERIGHE, art. O2P e art. Q1P. Tappeto della collezione TRAMATO art. TR653 L 231 cm P 196 cm.

This composition includes two backlit mirrors: one art. SUPERLUNA90W Ø 90 cm and art. CIRCUS90W Ø 90 cm; INDIGO taps art. ND301GR, graphite finish. The cabinet, L 290.4 cm D 47 cm H 37.5 cm, is composed of two sink units art. ILIM272, two bases art. IBIM272, one side panel art. IFRI47 and one side panel art. IFI47; top front panel and sides are lacquered Basalto in the silk finish while the fronts are in Noce Canaletto. The Colormood top in Basalto color art. DECK147, L 290.4 cm P 47 cm and 1.2 cm thick with sizes on request, is complete with integrated Basalto lacquered towel rail and two integrated sinks art. BASICO47. Wall cabinet art. ICE6, L 72 cm H 25 cm D 14 cm, is in smoked glass and lacquered Basalto back in the embossed finish. The composition is completed with optional internal and external LED lighting, internal drawer accessories STRATO. TRALERIGHE wallpaper, art. O2P and art. Q1P. Carpet of the TRAMATO collection art. TR653 L 231 cm D 196 cm.





“TONO SU TONO”

“TONE ON TONE”





PIANA





PIANA

“TONO SU TONO”

“TONE ON TONE”





“TONO SU TONO”

“TONE ON TONE”





PIANA



“TONO SU TONO”

“TONE ON TONE”



PIANA

Nella foto in alto e a sinistra, vasca art. REFLEXMOOD in Colormood colore Delfino, rubinetteria INDIGO art. ND903GR finitura grafite. A parete due colonne della collezione Bespoke art. KC3190, L 90 cm P 21,6 cm H 125 cm, con struttura in Skin cenere, cornice in finitura bronzo e frontale in vetro riflettente fumè.

In the photo above and on the left, bathtub art. REFLEXMOOD in Colormood color Delfino, INDIGO taps art. ND903GR graphite finish. On the wall two columns from the Bespoke collection. Art.KC3190, L 90 cm D 21.6 cm H 125 cm, with carcass in Skin cenere, frame in bronze finish and front in fumè reflective glass.

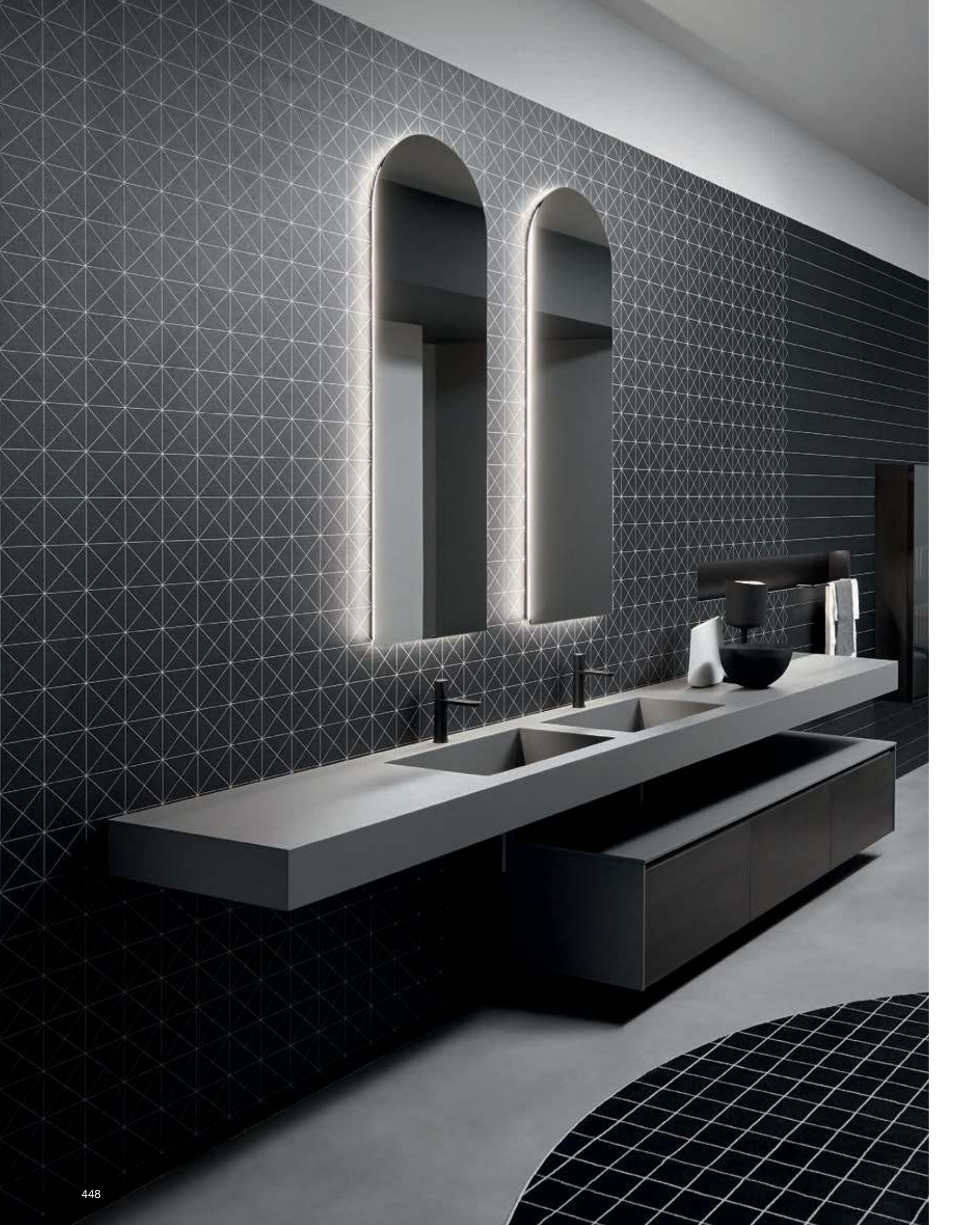

“TONO SU TONO”

“TONE ON TONE”



PIANA

Questa composizione comprende due specchi retroilluminati art. USB20144W L 50 cm H 144 cm; rubinetteria INDIGO art. ND301GR, finitura grafite. Il mobile, L 218,4 cm P 54 cm H 37,5 cm, è composto da tre basi art. IBI272, due fianchi art. IFI54; fascia frontale e fianchi sono laccati Delfino seta, le ante sono in Rovere grigio; completa la composizione il top in Colormood colore Delfino sp. 1,2 cm. Il top scatolato in Colormood colore Delfino art. BCS54, con misure su richiesta, L 360 cm P 54 cm sp. 12,5 cm, è completo di due lavabi integrati art. NIDO72. A parete mensola ad incasso art. OMBRAL colore nero, L 162 cm, con portasalviette art. OMBRAP36 colore nero L 36 cm. Carta da parati TRALERIGHE, art. A10N e art. O10N. Tappeto della collezione TRAMATO art. TR820 Ø 300 cm.

This composition includes two backlit mirrors art. USB20144W L 50cm H 144cm; INDIGO taps art. ND301GR, graphite finish. The cabinet, L 218.4 cm D 54 cm H 37.5 cm, is composed of three cabinets art. IBI272, two side panels art. IFI54; front band and sides are lacquered Delfino in the silk finish, the doors are in Rovere grigio; the composition is completed by the top in Colormood color Delfino 1.2 cm thick. The boxy top in Colormood color Delfino art. BCS54, with measures on request, L 360 cm P 54 cm 12.5 cm thick, is complete with two integrated sinks art. NIDO72. Wall-mounted recessed shelf art. OMBRAL black color, L 162 cm, with towel holder art. OMBRAP36 black color L 36 cm. TRALERIGHE wallpaper, art. A10N and art. O10N. Carpet of the TRAMATO collection art. TR820 Ø 300 cm.





La composizione L 218,4 cm, P 54 cm, H 50 cm, laccata Matita gofrato, è composta da due fianchi art. IFA54, da un porta lavabo con due ante L 72 cm art. IL5472, da una base con due cassetti L 72 cm art. IB472, e da due basi con anta L 36 cm art. IB5236. Il top è in Flumood Bianco art. BC154, con lavabo integrato art. NIDO72 e rubinetteria AYATI in finitura satinata art. AY200SA. Lo specchio L 216 cm, H 75 cm, con illuminazione a led luce bianca è art. FLASH75W.

The composition L 218,4 cm, D 54 cm, H 50 cm lacquered embossed Matita, is made up of two side panels art. IFA54 a double door sink unit L 72 cm art. IL5472, a double drawer cabinet L 72 cm art. IB472, two cabinets L 36 cm art. IB5236. A white Flumood top art. BC154 with integrated sink art. NIDO72 and satin AYATI tap art. AY200SA. The mirror is L 216 cm, H 75 cm white LED lighting art. FLASH75W.



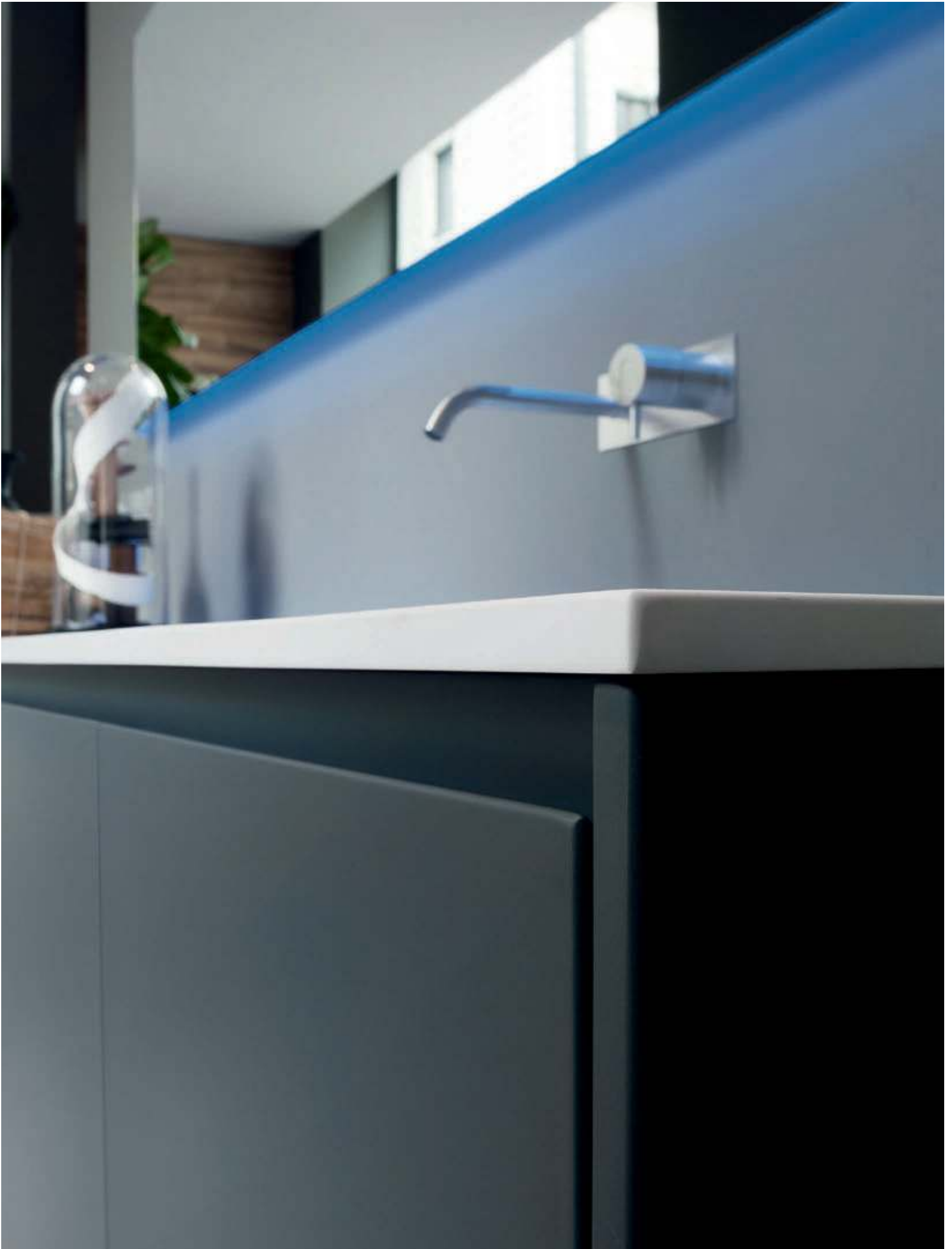





PIANA

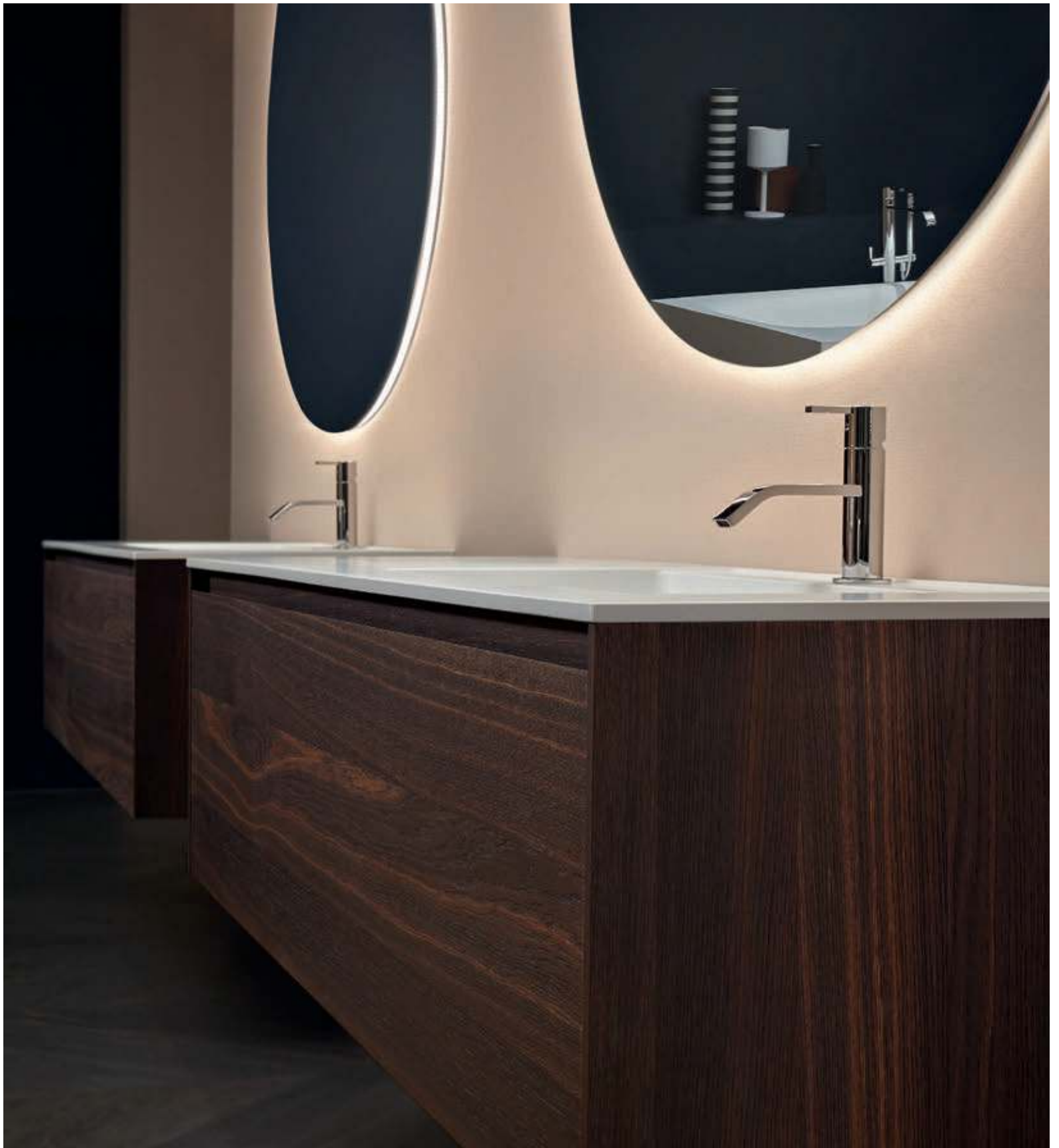

I due mobili gemelli nella foto, realizzati in Rovere thermo, sono entrambi composti da due fianchi art. IFI47, un porta lavabo con cassetto art. ILIM290, una base con cassetto art. IBIM245, nella quale è stato inserito un cassetto opzionale art. SLIM40. Il top art. BC147, con lavabo integrato art. BASICO47 è in Flumood Bianco, L 137,4 cm P 47 cm, spessore 1,2 mm. Il rubinetto della serie BIKAPPA è l'art. BK400N, gli specchi sono entrambi art. CIRCUS120W. L'attrezzatura dei cassetti è della collezione STRATO.

The two twin cabinets in the photo in Rovere thermo, are both made up of two sides panel art. IFI47, a sink unit with drawer art. ILIM290, a cabinet with drawer art. IBIM245 where an internal drawer was added art. SLIM40. The top art. BC147 with integrated sink art. BASICO47 is in white Flumood, L 137,4 cm D 47 cm, thickness 12 mm. BIKAPPA tap art. BK400N, the mirrors are both art. CIRCUS120W. The internal drawer accessories are STRATO.







PIANA



Lo specchio con illuminazione a led corredato di lampada LUCENTE è un art. CIRCUS1108W Ø 108 cm. Il mobile in finitura Rovere thermo L 182,4 cm, P 54 cm, H 37,5 cm è composto da due fianchi art. IFI54, una base portalavabo art. ILI290 e una base art. IBI290. Il top con lavabo integrato art. NUVOLA è in Flumood Falena, la rubinetteria è INDIGO art. ND301 finitura grafite.

The mirror with led lighting and lamp LUCENTE is art. CIRCUS1108W Ø 108 cm. The cabinet is in Rovere thermo L 182,4 cm D 54 cm, H 37,5 cm, made up of two end panels art. IFI54, a sink unit art. ILI290 and a cabinet art. IBI290. The top with integrated basin art. NUVOLA is in Flumood Falena color, tap series is INDIGO art. ND301GR graphite finish.



PIANA





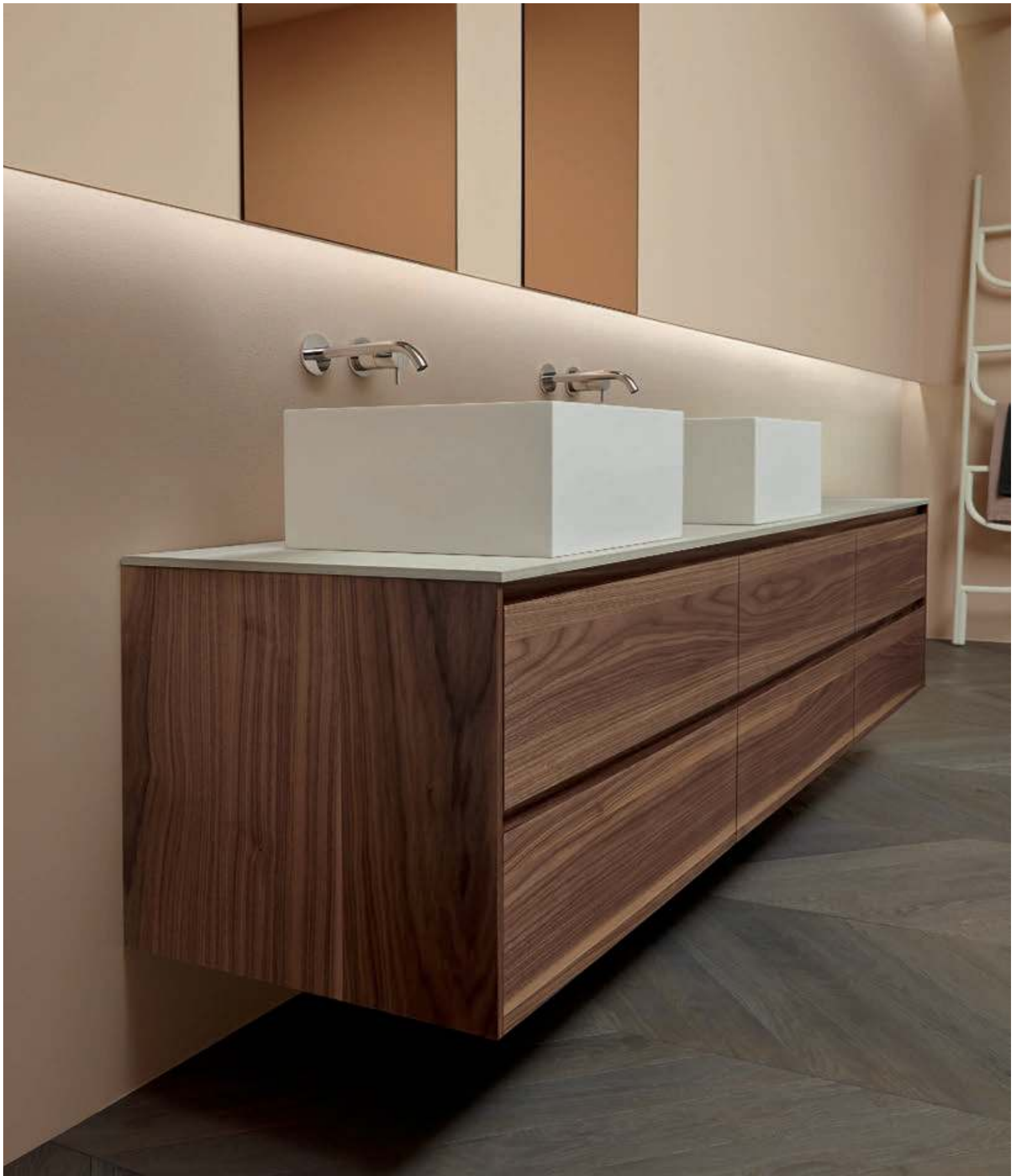

Il mobile in Noce canaletto è composto da due basi porta lavabo art. IL1872, L 72 cm, P 54 cm, H 50 cm ciascuna e una base art. IB872, L 72 cm, P 54 cm, H 50 cm, a chiusura due fianchi art. IFA54, P 54 cm, H 50 cm. Il top di spessore 1,2 cm è in Flumood Falena. I lavabi sono due art. STRATOS3 mentre la rubinetteria AYATI in acciaio lucido è art. AY921LU e art. AY600LU.



Furniture in Noce canaletto made up of two sink units art. IL1872, L 72 cm, D 54 cm, H 50 cm each and one cabinet art. IB872, L 72 cm, D 54 cm, H 50 cm, finishing panel on either side art. IFA54, D 54 cm, H 50. The top is in Flumood Falena, 1,2 cm thick. Two sinks art. STRATOS3 and AYATI tap series art. AY921LU and art. AY600LU in polished stainless steel.





PIANA



Nella foto a sinistra troviamo un mobile sospeso in Noce canaletto composto da una base art. IBB290, L 90 cm, H 25 cm, P 54 cm, da due basi art. IBB245 L 45 cm, H 25 cm, P 54 cm, due fianchi art. IFB54 e un top in legno Noce canaletto art. IT21, L 182,4 cm, P 54 cm. Il Top scatolare è in Flumood Bianco art. BCS54 con lavabo integrato art. OSM54. Rubinetteria INDIGO finitura grafite, art. ND601 e ND921.

Lo specchio è un Collage art. COLLAGE227, L 72 cm, H 75 cm. A sinistra termoarredo Bitlight colore Terracotta gofrato, art. BITL180E L 180 cm, con portasalviette art. BITBARRA dello stesso colore.

La composizione in alto in questa pagina differisce dall'altra per la posizione del lavabo integrato e delle tre basi. Lo specchio è un Collage art. COLLAGE225. L'attrezzatura dei cassetti è della collezione Strato, art. SRC5445 e SRC5490.

On the left suspended cabinet in Noce Canaletto made up of cabinet art. IBB290, L 90 cm, H 25 cm, D 54 cm and other two cabinets art. IBB245 L 45 cm, H 25 cm, D 54 cm, two side panels art. IFB54 and wood top in Noce Canaletto art. IT21, L 182,4 cm, P 54 cm. Boxy top in white Flumood art. BCS54 with integrated sink art. OSM54. INDIGO tap in graphite finish art. ND601 and ND921. The mirror is COLLAGE227 L 72 cm H 75 cm. On the left radiator Bitlight color embossed Terracotta art. BITL180E L 180 cm with towel rail art. BITBARRA of the same color.

The composition above on this page differs because of the position of the sink and the three cabinets. The mirror is art. COLLAGE225 and the internal drawer accessories art. SRC5445 and SRC5490.



PIANA



La composizione comprende un modulo di L 110,4 cm, P 47 cm e H 50 cm, laccato Bianco mood lucido, è composta da un fianco art. IFA47, da un fianco a giorno con ripiano art. IFG247, e da un porta lavabo con due cassetti art. ILM490. Il top in Flumood Bianco art. BC147 con lavabo integrato art. BASICO47, completo di rubinetteria BIKAPPA in finitura cromo lucido art. BK400N. Lo specchio art. VARIO100W L 108 cm, H 100 cm.

The composition includes one cabinet L 110,4 cm, D 47 cm and H 50 cm lacquered glossy Bianco Mood and is made up of one side panel art. IFA47 an open side panel with shelf art. IFG247 and one sink unit with two drawers art. ILM490. The top is in white Flumood art. BC147 with integrated sink art. BASICO47 complete with BIKAPPA tap series art. BK400N polished chrome. The mirrors art. VARIO100W L 108 cm, H 100 cm.



PIANA





Il mobile nella foto di dimensioni L 164,4 cm, P 54 cm, H 37,5 cm, è composto da un fianco art. IFI54, una base con cassetto art. IBI272, un porta lavabo art. ILI272; a destra chiude la composizione un vano a giorno art. IFG154, finitura Bianco mood lucido. Il top art. BC154, con lavabo integrato art. NUVOLA è in Flumood Bianco, L 164,4 cm, P 54 cm, Sp 1,2 cm. Il rubinetto della serie BIKAPPA in finitura cromo lucido è l'art. BK400N, lo specchio con illuminazione a led completo di lampada LUCENTE è l'art. CIRCUS1108W. In appoggio sul top un vassoio in Noce canaletto della collezione DOMINO.

The composition in the photo measuring L 164,4 cm, D 54 cm, H 37,5 cm is made up of art. IFI54, a cabinet with drawer art. IBI272, a sink unit art. ILI272 and on the right side open shelves art. IFG154. Finish is glossy Bianco mood. The top art. BC154 with integrated sink art. NUVOLA is in white Flumood, L 164,4 cm, D 54 cm thickness 1,2 cm. The polished chrome tap is from the BIKAPPA series art. BK400N, the mirror with led lighting complete with LUCENTE lamp is art. CIRCUS1108W. On the top of the cabinet a tray in Noce canaletto from collection DOMINO.



Il mobile colore Pompeiano goffrato è composto da un porta lavabo art. ILIM272, L 72 cm, H 37,5 cm, P 47 cm, da una base art. IBIM272 delle stesse dimensioni, un fianco art. IFI47 e un vano a giorno con ripiano, art IFG147. Top in Flumood Bianco art. BC147 L 164,4 cm P 47 cm Sp 1,2 cm con lavabo art. GESTOMOOD54. Il rubinetto a destra è un art. AY301SA in acciaio satinato, della collezione Ayati, mentre quello della foto in alto è un AY921SA sempre in acciaio satinato con miscelatore art. TANK nero. Lo specchio completo di lampada LUCENTE è un art. CIRCUS1108W versione sinistra.

The cabinet lacquered embossed Pompeiano has a sink unit art. ILIM272 L 72 cm H 37,5 cm P 47 cm, a cabinet art. IBIM272 of the same measurements, a side panel art. IFI47 and side panel with shelf art. IFG147. Top is in white Flumood art. BC147 L 164,4 cm D 47 cm and 1,2 cm thick with sink art. GESTOMOOD54. On the right Ayati tap art. AY301SA in satin steel and above art. AY921SA in satin steel with mixer art. TANK in black. The mirror complete with Lucente lamp is art. CIRCUS1108W left version.



PIANA





La composizione ospita il mobile, verniciato gofrato Terracotta, composto da un porta lavabo art. ILI272, da una base art. IBI272 un fianco art. IFI54 e un vano a giorno con ripiano, art IFG154. Top in Flumood Bianco art. BC154 L 164,4 cm P 54 cm Sp 1,2 cm con lavabo integrato art. NUVOLA. Rubinetteria INDIGO art. ND301 finitura grafite. Lo specchio, completo di lampada LUCENTE, è art. CIRCUS1108W Ø 108 cm versione sinistra. A parete la carta da parati della collezione TRALERIGHE art. D2P e art. DD2P. La composizione è ulteriormente arricchita dai vasi in Crismood Nebbia, art. NISI1 e art. MASA1, e dal tappeto della collezione TRAMATO art. TR654 L 234 cm P 218 cm.

Cabinet lacquered embossed Terracotta with a sink unit art. ILI272, cabinet art. ILI272 and a cabinet art. IBI272, side panel art. IFI54 with open compartment and shelf art. IFG154. Top in white Flumood art. BC154 L 164,4 cm D 54 cm, 1,2 cm thick with integrated sink art. NUVOLA. INDIGO tap art. BD301 graphite finish. The mirror complete with Lecente lamp is art. CIRCUS1108W Ø 108 cm left version. Wallpaper from the TRALERIGHE collection art. D2P and art. DD2P. The composition is enriched by the Crismood vases Nebbia art. NISI1 and art. MASA1, carpet TRAMATO art. TR654 L 234 cm D 218 cm.





Specchio art. NEUTRO75, L 216 cm, sul quale è inserita la lampada art. LUCENTE216. Il mobile laccato Tortora lucido è composto da due porta lavabi con cassetto L 72 cm art. ILI272, una base con cassetto L 72 cm art. IBI272 e una coppia di fianchi art. IFI54, per una lunghezza complessiva di L 218,4 cm, P 54 cm e H 37,5 cm. Il top è in Flumood Bianco art. BC154 con doppio lavabo integrato art. NUVOLA e rubinetteria BIKAPPA art. BK400N.

Mirror art. NEUTRO75, L 216 cm, with lamp art. LUCENTE216. The cabinet is lacquered glossy Tortora and made up of two sink units with drawer L 72 cm art. ILI272, a cabinet with drawer L 72 cm art. IBI272 and a pair of end panels art. IFI54, for a total length of L 218,4 cm, D 54 cm and H 37,5 cm. The top in white Flumood art. BC154 with double integrated sinks art. NUVOLA and BIKAPPA tap art. BK400N.



La composizione L 182,4 cm comprende, uno specchio L 180 cm, H 100 cm art. FLASH100W. Il mobile è laccato Bianco gofrato, composto da un porta lavabo con due cassette di cui uno sagomato internamente per sifone, L 72 cm, P 54 cm, H 50 cm art. IL472, da tre basi L 36 cm, H 50 cm, P 54 cm art. IB5236, da due fianchi art. IFA54. Il top in vetro laccato Bianco lucido art. 910 con lavabo integrato art. SOAP72 è completo di rubinetteria AYATI art. AY301LU, in finitura lucida.

The composition L 182,4 cm includes a mirror L 180 cm, H 100 cm art. FLASH100W; the lacquered cabinet color embossed Bianco is composed by a double drawer sink unit one of which internally shaped for siphon L 72 cm, D 54 cm, H 50 cm art. IL472, three modules L 36 cm, H 50 cm, D 54 cm art. IB5236 and two side panels art. IFA54. Glass top art. 910 lacquered Bianco, with integrated sink art. SOAP72 ; polished AYATI tap art. AY301LU.



PIANA





La composizione L 92,4 cm, comprende uno specchio L 54 cm, H 110 cm, art. NEUTRO110. Il mobile è laccato Bianco lucido, composto da un porta lavabo art. IL890, con fascia centrale, un frontale fisso e cassetto, L 90 cm, P 54 cm, H 50 cm e da due fianchi art. IFA54.

Il top è in Flumood Bianco art. BC154, con lavabo integrato art. NIDO72 e la rubinetteria AYATI art. AY301LU, in finitura lucida.

The composition L 92,4 cm includes a mirror L 54 cm, H 110 cm art. NEUTRO110. The cabinet is lacquered glossy Bianco and is made up of a sink unit art. IL890 with center panel, a fixed front and drawer, L 90 cm, P 54 cm, H 50 cm and two sides art. IFA54. White Flumood top art. BC154 with integrated sink art. NIDO72 and polished AYATI tap art. AY301LU.



La composizione L 146,4 cm, comprende uno specchio L 50 cm, H 108 cm, art. SPIO5W. Il mobile è laccato Creta goffrato, composto da un porta lavabo con due ante art. IL5472, L 72 cm, P 54 cm, H 50 cm, da una base con doppio cassetto art. IB472 e da due fianchi art. IFA54.

Il top è in Flumood Bianco art. BC154, con lavabo integrato art. NIDO72 e la rubinetteria è AYATI art. AY302LU, in finitura lucida.

The composition L 146,4 cm includes a mirror L 50 cm, H 108 cm art. SPIO5W. The cabinet, lacquered embossed Creta, is made up of a double door sink unit art. IL5472, L 72 cm, D 54 cm, H 50 cm, a double drawer module art. IB472 and two side panels art. IFA54. White Flumood top art. BC154 with integrated sink art. NIDO72 and polished AYATI tap art. AY302LU.



PIANA FINITURE - FINISHES

A



Bianco lucido/colorato opaco o gofrato, come da nostro campionario colori



Glossy white/Matt lacquered or embossed, as per our colour samples

D



Colorato lucido/finitura seta, come da nostro campionario colori



Glossy lacquered/Silk finish, as per our colour samples

O

Venatura orizzontale / Horizontal grain

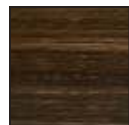

Rovere: sbiancato, naturale castano, moro, grigio, matita, ardesia, thermo.

Noce: canadese, visone, canaletto.

ALTEZZE MOBILI H 25 - 37,5 - 50 | FURNITURE HEIGHTS H 25 - 37,5 - 50

SOLUZIONE "A" | SOLUTION "A"

Elementi con fascia superiore.
Elements with upper front panel.

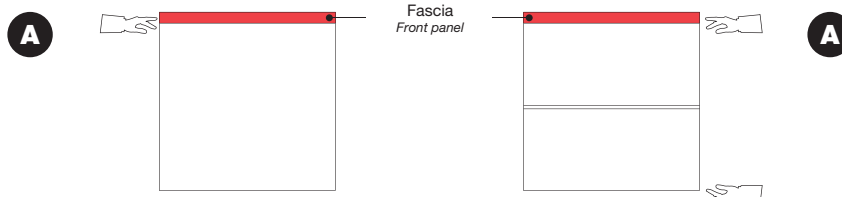

SOLUZIONE "B" | SOLUTION "B"

Elementi con fascia centrale.
Elements with middle front panel.

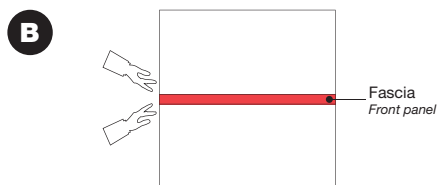

SOLUZIONE "C" | SOLUTION "C"

Elementi con fascia superiore e centrale.
Elements with upper and middle front panel.

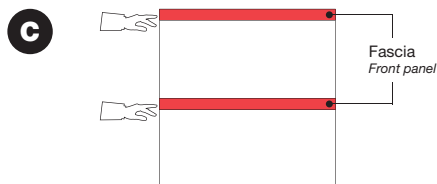

SCHEMA COMPATIBILITÀ | COMPATIBILITY DIAGRAM

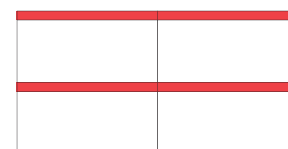
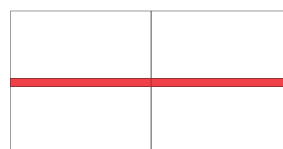
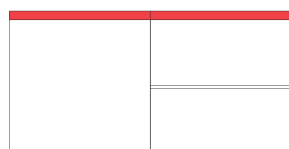



PIANA

PIANA COMPONENTI - COMPONENTS

ACCESSORI | ACCESSORIES

art. PICCO

Set di n°4 piedini con livellatore, per ogni elemento. Non necessita di zoccolo.

Set of 4 regulating feet for each element. Does not need a plinth.



H	Ø
3	5

Vano a giorno con 1 ripiano, da aggiungere a dx o sx della composizione finale, formata da uno o più componenti.

Open side panel with 1 shelf to add on the right or left of the final composition made up of one or more elements.

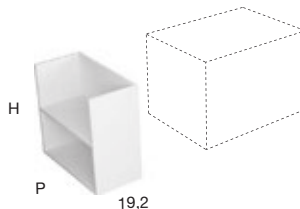

H	P
37,5	40
50	47
	54

FIANCHI | SIDES

Fianco da aggiungere a dx e sx della composizione, formata da uno o più componenti.

Side panel to add on to the right and left of each composition made up of one or more components.

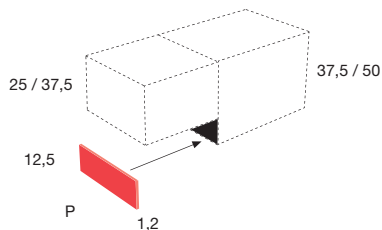

H	P
12,5	40
	47
	54

Fianco da aggiungere a dx e sx della composizione, formata da uno o più componenti.

Side panel to add on to the right and left of each composition made up of one or more components.

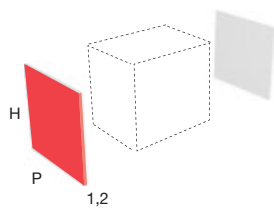

H	P
25	40
37,5	47
50	54

Fianco da aggiungere a dx e sx della composizione, formata da uno o più componenti, con top Art. PONTE40, Art. PONTE47, Art. PONTE54, Art. PONTE140, Art. PONTE147 e Art. PONTE154.

Side panel to add on to the right and left of the final composition made of one or more elements with top Art. PONTE40, Art. PONTE47, Art. PONTE54, Art. PONTE140, Art. PONTE147 and Art. PONTE154.



H	Per mobili - For cabinets	H	P
35	37,5		40
47,5	50		47
			54

PORTA LAVABI | SINK UNITS

Porta lavabo con 1 cassetto Art. SLIM ed il fondo sagomati internamente per sifone.

Sink unit with 1 drawer Art. SLIM and bottom shaped internally for siphon.

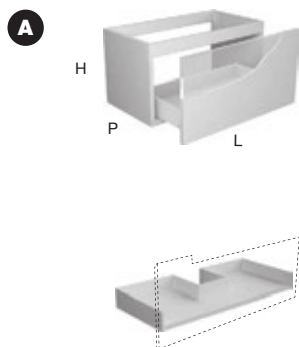

H	P	L
25	40	54 - 63 - 72 - 90 - 108 - 126
37,5	47	
	54	

Porta lavabo con 1 cassetto Art. SLIM.

Large drawer sink unit Art. SLIM.

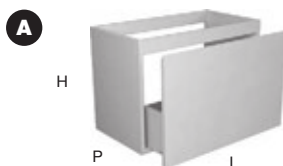

H	P	L
37,5	40	54 - 63 - 72 - 90 - 108 - 126
50	47	
	54	

Porta lavabo con 2 cassetti Art. SLIM di cui 1 sagomato internamente per sifone.

Double drawer Art. SLIM sink unit one of which internally shaped for siphon.

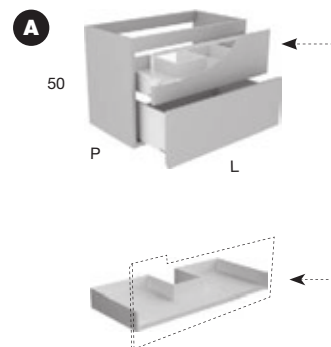

H	P	L
50	40	54 - 63 - 72 - 90 - 108 - 126
	47	
	54	

Porta lavabo dx o sx con 1 anta.
Right or left single door sink unit.

Porta lavabo con 2 ante.
Double door sink unit.

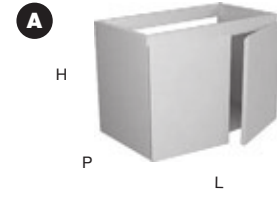
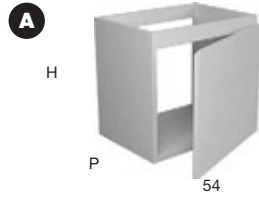

H	P	L
37,5	40	54
50	47	
	54	

H	P	L
37,5	40	72 - 90 - 108
50	47	
	54	

PORTA LAVABI | SINK UNITS

Base con 1 cassetto Art. SLIM.
Single drawer cabinet Art. SLIM.

Base con 2 cassetti Art. SLIM.
Cabinet with 2 drawers Art. SLIM.

Base dx o sx con 1 anta.
Right or left single door cabinet.

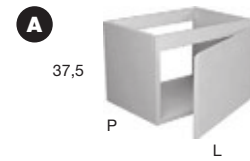
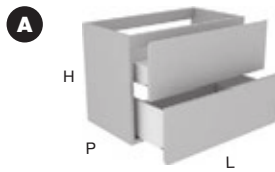
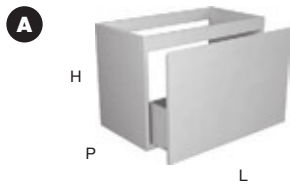

H	P	L
25	40	27 - 36 - 45 - 54 - 63 - 72 - 90 - 108 - 126
37,5	47	
50	54	

H	P	L
37,5	40	27 - 36 - 45 - 54 - 63 - 72 - 90 - 108 - 126
50	47	
	54	

H	P	L
37,5	40	36 - 45 - 54
	47	
	54	

BASI | CABINETS

PIANA

Base dx o sx con 1 anta e 1 ripiano interno.
Right or left single door cabinet with 1 inner shelf.

Base con 2 ante.
Double door cabinet.

Base con 2 ante e 1 ripiano interno.
Double door cabinet with 1 internal shelf.

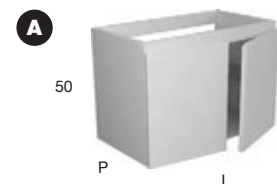
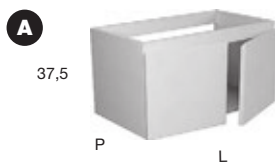
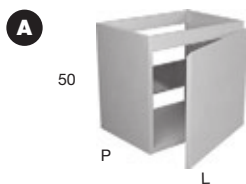

H	P	L
50	40	36 - 45 - 54
	47	
	54	

H	P	L
37,5	40	72 - 90 - 108
	47	
	54	

H	P	L
50	40	72 - 90 - 108
	47	
	54	

BASI | CABINETS

PIANA COMPONENTI - COMPONENTS

PORTA LAVABI E BASI | SINK UNITS AND CABINETS

Porta lavabo con fascia centrale, 1 frontale fisso ed 1 cassetto Art. SLIM.

Sink unit with middle front panel, fixed front and 1 drawer Art. SLIM.

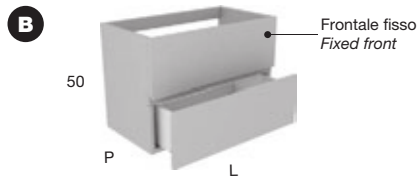

H	P	L
50	40	54 - 63 - 72 - 90 - 108 - 126
	47	
	54	

Porta lavabo con fascia centrale, 2 cassetti Art. SLIM di cui 1 sagomato internamente per sifone. Solo per lavabi sopraiano.

Sink unit with middle front panel, 2 drawers Art. SLIM of which 1 internally shaped for siphon. Only for top mount sinks.

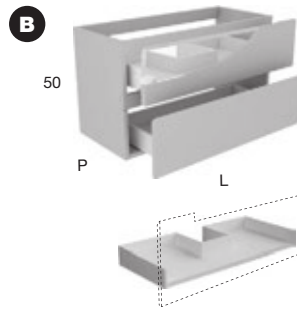

H	P	L
50	40	54 - 63 - 72 - 90 - 108 - 126
	47	
	54	

Base con fascia centrale e 2 cassetti Art. SLIM.
Cabinet with middle front panel and 2 drawers Art. SLIM.

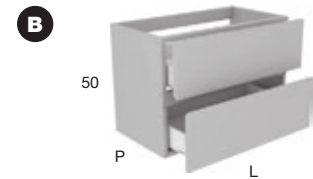

H	P	L
50	40	27 - 36 - 45 - 54 - 63 - 72 - 90 - 108 - 126
	47	
	54	

PORTA LAVABI E BASI | SINK UNITS AND CABINETS

Porta lavabo con fascia centrale, superiore e 2 cassetti Art. SLIM di cui 1 sagomato internamente per sifone.

Double drawer sink unit Art. SLIM, one of which internally shaped for siphon, middle and upper front panel.

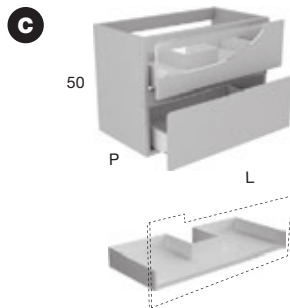

H	P	L
50	40	54 - 63 - 72 - 90 - 108 - 126
	47	
	54	

Base con fascia centrale, superiore e 2 cassetti Art. SLIM.

Cabinet with middle and upper front panel and 2 drawers Art. SLIM.

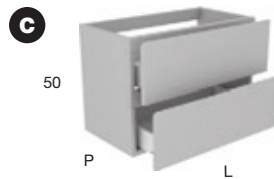

H	P	L
50	40	27 - 36 - 45 - 54 - 63 - 72 - 90 - 108 - 126
	47	
	54	

BASI | CABINETS

Base con 1 vano a giorno.
Open cabinet with 1 compartment.

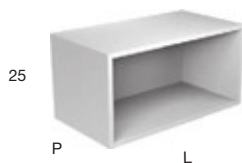

H	P	L
25	40	36 - 45 - 54 - 72
	47	
	54	

Base con 2 vani a giorno.
Open cabinet with 2 compartments.

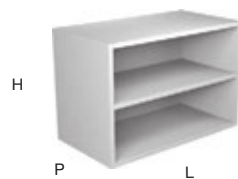

H	P	L
37,5	40	36 - 45 - 54 - 72
50	47	
	54	

Pensile dx o sx con 1 anta e 1 ripiano interno.
Right or left single door wall cabinet with 1 internal shelf

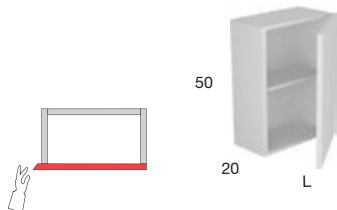

H P L
 50 20 27 - 36 - 45 - 54

Pensile dx o sx con 1 anta e 2 ripiani interni.
Right or left single door wall cabinet with 2 internal shelves

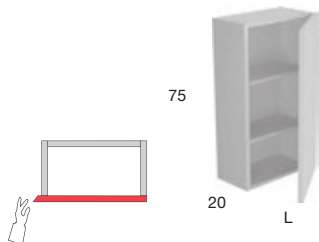

H P L
 75 20 27 - 36 - 45 - 54

Pensile dx o sx con 1 anta e 2 ripiani interni.
Right or left single door wall cabinet with 2 internal shelves

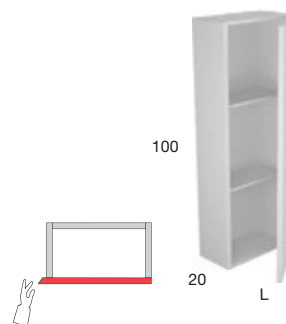

H P L
 100 20 27 - 36 - 45 - 54

PENSILI | WALL CABINETS

Colonna dx o sx con 1 anta e 2 ripiani interni.
Right or left single door high cabinet with 2 internal shelves

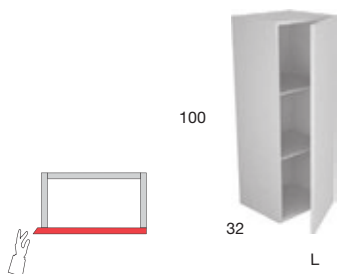

H P L
 100 32 27 - 36 - 45 - 54

Colonna dx o sx con 1 anta e 3 ripiani interni.
Right or left single door high cabinet with 3 internal shelves

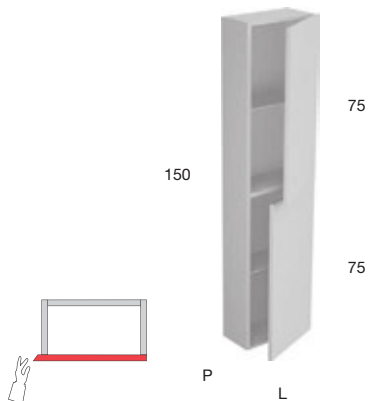

H P L
 150 20 36 - 45
 32

Colonna dx o sx con 2 ante e 5 ripiani interni.
Right or left double door high cabinet with 5 internal shelves

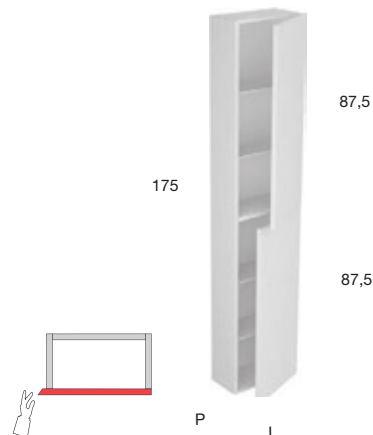

H P L
 175 20 36 - 45
 32

COLONNE | HIGH CABINETS

PIANA

BINARIO 03_BINARIO 12

2019

design_Nevio Tellatin

Una collezione di mobili dall'immagine essenziale e dalle linee pulite com'è nello stile di antoniolupi, ma con un segno grafico importante che diventa decoro geometrico per esaltare la matericità delle superfici e valorizzare il volume dei contenitori.

Linee parallele come binari incidono i frontali dell'anta e dei fianchi, conferendo tridimensionalità alla superficie e vestendo il mobile con una "plissettatura" che ne alleggerisce visivamente l'immagine.

Distanziate tra loro di 3 mm in Binario 03 e 12 mm in Binario 12, le fresature scandiscono lo sviluppo longitudinale del contenitore, opponendo una traccia verticale molto fitta che "misura" la proporzione dell'anta, arricchendo di significato l'intero progetto.

Binario 03 è disponibile solamente in versione laccata finitura opaca o goffrata in tutti i colori dell'ampia gamma antoniolupi.

I contenitori della collezione Binario 03 sono abbinabili ai top della serie Ponte, che si innestano perfettamente sui volumi per dar vita a una gola che si sviluppa lungo tutta la composizione e permette un'agevole apertura dell'anta.

Uno sfondato che dona movimento e profondità all'insieme, un gioco d'ombre che "disegna" l'immagine finale del mobile.

Binario 12 è disponibile sia nella versione in essenza di legno che in quella laccata in finitura opaca o goffrata.

La collezione è abbinabile a tutti i top di antoniolupi con i quali da vita a un legame solidale che definisce un volume puro e perfetto.

La collezione Binario 12 può essere declinata anche nella versione con fianchi lisci così da valorizzare per contrasto le superfici e dare ancora maggior risalto al frontale.

A furniture collection with an essential image and clean lines, as is the style of antoniolupi.

An important graphic sign that becomes a geometric decoration to enhance the materiality of the surfaces and enhance the volume of the containers.

Parallel lines like rails engrave the fronts and the sides, giving three-dimensionality to the surface and dressing the piece of furniture with a "pleating" effect that visually lightens it.

Spaced 3 mm apart in Binario 03 and 12 mm in Binario 12, the millings articulate the longitudinal development of the furniture, opposing a very dense vertical trace that "measures" the proportion of the front, enriching the entire project.

Binario 03 is only available in a matt or embossed lacquered version in all the colors of the antoniolupi range.

The furniture of the Binario 03 collection can be combined with the tops of the Ponte series, which fit perfectly to create a groove that extends along the entire composition and allows for easy opening of the front.

A texture that gives movement and depth to the whole, a play of shadows that "draws" the final image of the furniture.

Binario 12 is available both in the wood essence version and in the lacquered version in matt or embossed finish.







Ogni composizione, perfettamente identica all'altra, comprende lo specchio retroilluminato art. CIRCUS120W Ø 120 cm; rubinetteria INDIGO art. ND301 finitura grafite. Il mobile, verniciato goffrato Vespa e con fascia superiore verniciata goffrata Bianco mood, è composto da un porta lavabo art. B03LIM290, una base art. B03BIM245 e da due fianchi art. B03FI47; si completa dell'attrezzatura interna STRATO. Il top a ponte, art. PONTE47 L 137,4 cm P 47 cm Sp 1,2 cm, è in Flumood Bianco e ospita il lavabo integrato art. BASICO47. Tappeto della collezione GEOMETRIE VOLANTI art. GV510 L 400 cm P 100 cm.

Each composition identical to the other with backlit mirror art. CIRCUS120W Ø 120 cm; INDIGO tap art. ND301 graphite finish. The cabinet lacquered embossed Vespa and with upper panel lacquered embossed Bianco mood has a sink unit art. B03LIM290, cabinet art. B03BIM245 and two side panels art. B03FI47; internal drawer accessories STRATO and top art. PONTE47 L 137,4 cm D 47 cm and 1,2 cm thick in white Flumood and integrated sink art. BASICO47. Carpet from the GEOMETRIE VOLANTI collection art. GV510 L 400 cm D 100 cm.





“TONO SU TONO”

“TONE ON TONE”

Una perfetta integrazione cromatica per un total look assoluto dell'ambiente bagno, un “velo” di colore che ricopre in modo uniforme tutti gli elementi, per esprimere al meglio uno stile e un carattere identitario. Grazie al Colormood il bagno antoniolupi si tinge di colore in tutti i suoi protagonisti più significativi, costruisce un senso di appartenenza che deriva da una coerenza estetica che coinvolge volumi scultorei e articolati ma anche forme semplici e accessori complementari.

Dai top dei mobili ai fianchi dei contenitori, dalle vasche freestanding ai lavabi di diversa tipologia, dai soffioni al radiatore BIT, dalle piantane alle manopole del rubinetto Indigo, dalle barre portasalviette ai profili di alcune collezioni di mobili. Un'uniformità estetica caratterizzata da una finitura opaca e morbida al tatto, che semplifica la lettura dei volumi, che regolarizza le linee e definisce le dimensioni, che mette in risalto quelle proporzioni che nelle collezioni di antoniolupi trovano un equilibrio assoluto. Una gamma colori che consente un'ampia scelta e permette di instaurare un dialogo con gli altri materiali e finiture presenti nell'ambiente bagno, come le texture uniche dei legni, i riflessi dei metalli e del vetro che giocano con la luce, le venature irripetibili delle pietre, l'omogeneità assoluta dei solid surfaces.

A perfect chromatic integration for an absolute total look of the bathroom, a “veil” of color that uniformly covers all the elements, to best express a style and an identity. Thanks to Colormood, the antoniolupi bathroom is tinged with color in all its most significant protagonists, building a sense of belonging that derives from an aesthetic coherence that involves sculptural and articulate volumes but also simple shapes and complementary accessories.

From the tops of the furniture to the sides of the cabinets, from the freestanding bathtubs to the various types of sinks, from the showerheads to the BIT radiators, from the freestanding accessories to the knobs of the Indigo taps, from the towel rails to the profiles of some of the furniture collections. A uniform consistency characterized by a matt finish that is soft to the touch and simplifies the reading of volumes, defining the lines and dimensions that highlights proportions that find an absolute balance in the antoniolupi collections. A range of colors that allows a wide choice and allows you to establish a dialogue with the other materials and finishes present in the bathroom, such as the unique textures of the woods, the light reflections of the metals and glass, the unrepeatability of the stones, the absolute homogeneity of solid surfaces.





BINARIO



“TONO SU TONO”

“TONE ON TONE”



BINARIO



La composizione comprende lo specchio art. COLLAGE305 L 54 cm H 75 cm, rubinetteria INDIGO art. ND921 e art. ND601 finitura grafite. Il mobile, verniciato gofrato Veneziano, è composto da un porta lavabo art. B03LI272, tre basi art. B03BI236 e da due fianchi art. B03FI54. Il top a ponte, art. PONTE54 L 182,4 cm P 54 cm Sp 1,2 cm in Flumood Falena, ospita il lavabo integrato art. NIDO72.

A parete, portasalviette art. RETTA4108 verniciato gofrato Coccodrillo. Tappeto della collezione GEOMETRIE VOLANTI art. GV645 L 300 cm P 200 cm.

The composition is made up of a mirror art. COLLAGE305 L 54cm H 75 cm, INDIGO tap art. ND921 and art. ND601 graphite finish. The cabinet lacquered embossed Veneziano has sink unit art. B03LI272, three cabinets art. B03BI236 and two side panels art. B03FI54. Top art. PONTE54 L 182,4 cm D 54 and 1,2 cm thick in Flumood color Falena with integrated sink art. NIDO72.

On the wall towel bar, lacquered embossed Coccodrillo. Carpet from the GEOMETRIE VOLANTI COLLECTION art. GV645 L 300 cm D 200 cm.



BINARIO

La composizione comprende la vasca art.REFLEX in Cristalmood Nebbia, rubinetteria INDIGO art. ND903 finitura grafite. A parete i pensili a giorno sono composti da due art. ICE4, L 27 cm P 14 cm H 25, in vetro fumè; uno con schienale verniciato goffrato Coccodrillo, l'altro verniciato goffrato Veneziano; un art. ICE6 L 72 cm P 14 cm H 25 cm in vetro fumè con schienale verniciato goffrato Grigio smog. I due termoarredo, art. BITL120E, sono verniciati goffrati Veneziano. Tappeto della collezione GEOMETRIE VOLANTI art. GV645 L 300 cm P 200 cm.

Bathtub art. Reflex in Cristalmood Nebbia, INDIGO tap art. ND903 graphite finish. On the wall open cabinets art. ICE4, L 27 cm D 14 cm H 25 cm in fume glass; one is lacquered embossed Coccodrillo and the other embossed Veneziano; art. ICE6 L 72 cm D 14 cm H 25 cm in fume glass with back lacquered embossed Grigio smog. The two radiators art. BITL120E lacquered Veneziano. Carpet of the GEOMETRIE VOLANTI art. GV645 L 300 cm D 200 cm.



antonio lupi



BINARIO









La composizione comprende lo specchio art. COLLAGE305 L 54 cm H 75 cm, rubinetteria INDIGO art. ND921 e art. ND601 finitura grafite. Il mobile, verniciato gofrato Anatra, è composto da un porta lavabo art. B03LIM272, tre basi art. B03BIM236 e da due fianchi art. B03FI47. Il top a ponte, art. PONTE47 L 182,4 cm P 47 cm Sp. 1,2 cm, in Flumood Serena, ospita il lavabo integrato art. GRAFFIO4772. A parete, portasalviette art. RETTA4108 verniciato gofrato Coccodrillo. Tappeto della collezione GEOMETRIE VOLANTI art. GV329 L 300 cm P 200 cm.

The composition includes art. COLLAGE305 L 54 cm H 75 cm, INDIGO tap art. ND921 and art. ND601 graphite finish. The cabinet lacquered embossed Anatra with sink unit art. B03LIM272, three cabinets art. B03BIM236 and two side panels art. B03FI47. Top is art. PONTE47 L 182,4 cm D 47 cm and 1,2 cm thick in Flumood Serena with integrated sink art. GRAFFIO4772. On the wall towel rail art. RETTA4108 lacquered embossed Coccodrillo, Carpet from the GEOMETRIE VOLANTI collection art. GV329 L 300 cm D 200 cm.





BINARIO





La composizione comprende lo specchio art. EDISON75W, L 180 cm H 75 cm; la rubinetteria è composta dall'erogatore AYATI art. AY921SA in acciaio satinato e dal miscelatore art. MAYDAY verniciato bianco. Il mobile, verniciato gofrato Matita e con fascia superiore verniciata gofrata Matita, è composto da un porta lavabo art. B03LIM290, due basi art. B03BIM245 e da due fianchi art. B03FI47; la composizione si completa dell'attrezzatura interna STRATO. Il top a ponte, art. PONTE47 L 182,4 cm P 47 cm Sp 1,2 cm, è in Flumood Serena e ospita, oltre al lavabo integrato art. NIDO72, gli accessori art. TABULA7127, art. TABULA3136 e la coppia di bicchieri art. PERCEZIONE. Tappeto della collezione TRAMATO art. TR811 Ø 250 cm.

Mirror art. EDISON75W, L 180 cm H 75 cm, AYATI tap art. AY921SA in satin steel and MAYDAY mixer lacquered white. The cabinet is lacquered embossed Matita and with top front panel lacquered embossed Matita, sink unit art. B03LIM290, two cabinets art. B03BIM245 and two side panels art. B03FI47. Internal drawer accessories STRATO. The top art. PONTE47 L 182,4 cm D 47 cm and 1,2 cm thick in Flumood Serena and integrated sink art. NIDO72, accessories art. TABULA7127 art. TABULA3136 and glasses art. PERCEZIONE. Carpet from the TRAMATO collection art. TR811 Ø 250 cm.



La composizione comprende gli specchi retroilluminati art. NEUTROLED90W, L 142 cm H 90 cm, e art. NEUTROLED125W L 72 cm H 125 cm; rubinetteria INDIGO art. ND921 e art. ND601 finitura grafite. Il mobile, in legno Rovere evaporato, è composto da due porta lavabi art. B12LI272, una base art. B12BI272 e da due fianchi fresati art. B12FRI54. I cassetti sono arricchiti dall'attrezzatura interna STRATO in vetro fumè.

Il top, art. BC154 L 216 cm P 54 cm Sp 1,2 cm in Flumood Falena, ospita i lavabi in appoggio art. SENSOC in Cristalmood Nebbia. Tappeto della collezione GEOMETRIE VOLANTI art. GV522 L 400 cm P 100 cm.

Backlit mirrors art. NEUTROLED90W, L 142 cm H 90 cm and art. NEUTROLED125W L 72 cm H 125 cm; INDIGO tap art. ND921 and art. ND601 graphite finish. The cabinet in wood Rovere evaporato has two sink units art. B12LI272 a cabinet art. B12BI272 and two milled sides art. B12FRI54. The drawers have the internal accessories STRATO in fume glass.

The top art. BC154 L 216 cm D 54 cm and 1,2 cm thick in Flumood Falena houses two top mount sinks art. SENSOC in Cristalmood Nebbia. Carpet from the GEOMETRIE VOLANTI collection art. GV522 L 400 cm D 100 cm.









La composizione comprende gli specchi retroilluminati art. NEUTROLED75W, L 180 cm H 75 cm, e art. NTKIT50W, L 180cm H 50 cm; una coppia di lampade a led da specchio art. BOLLA2. Rubinetteria AYATI art. AY921SA e art. AY610SA in acciaio satinato. Il mobile, verniciato goffrato Grigio smog, è composto da un porta lavabo art. B12LI290, due basi art. B12BI245, due fianchi fresati art. B12FRI54; la maniglia delle ante è art. SMART. Il top, art. BC154, L 180 cm P 54 Sp. 1,2 cm, in Flumood Serena ospita il lavabo integrato art. NUVOLA. Tappeto della collezione GEOMETRIE VOLANTI art. GV646 L 300 cm P 200 cm.

The mirrors are backlit art. NeutroLED75W L 180 cm H 75 cm and art. NTKIT50W L 180 cm H 50 cm; pair of led lamps art. BOLLA2. Ayati taps art. AY921SA and art. AY610SA in satin steel.

The cabinet lacquered embossed Grigio smog has a sink unit art. B12LI290, two cabinets art. B12BI245 and two milled sides art. B12FRI54, handle art. SMART.

The top is art. BC154 L 180 cm D 54 cm and 1,2 cm thick in Flumood Serena and integrated sink art. NUVOLA. Carpet from the GEOMETRIE VOLANTI collection art. GV646 L 300 cm D 200 cm.



Binario 12





Fianco fresato
Milled side



Fianco liscio
Smooth side

BINARIO 03 FINITURE - FINISHES

A



Bianco lucido/colorato
opaco o gofrato, come da
nostro campionario colori



*Glossy white/Matt
lacquered or embossed, as
per our colour samples*

BINARIO 12 FINITURE - FINISHES

A



Bianco lucido/colorato
opaco o gofrato, come da
nostro campionario colori



*Glossy white/Matt
lacquered or embossed, as
per our colour samples*

M



Rovere:
evaporato

FIANCO PERSONALIZZATO VERNICIATO O IN ESSENZA LEGNO | PERSONALIZED SIDE LACQUERED OR VENEERED



A



Bianco lucido/colorato
opaco o gofrato, come da
nostro campionario colori



*Glossy white/Matt
lacquered or embossed, as
per our colour samples*

M



Rovere:
evaporato

Fianco da aggiungere a dx e sx della composizione, formata da uno o più componenti, con top Art. PONTE40, Art. PONTE47, Art. PONTE54, Art. PONTE140, Art. PONTE147 e Art. PONTE154.

Side panel to add on the right and left of the final composition made of one or more elements with top Art. PONTE40, Art. PONTE47, Art. PONTE54, Art. PONTE140, Art. PONTE147 and Art. PONTE154.



H	Per mobili - For cabinets	H	P
35	37,5		40
47,5	50		47
			54

Porta lavabo con 1 cassetto Art. SLIM.
Large drawer sink unit Art. SLIM.

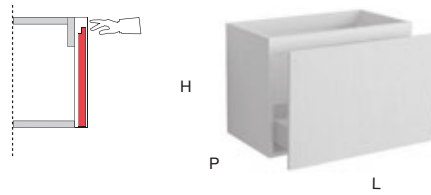

H	P	L
37,5	40	54 - 63 - 72 - 90 - 108
50	47	
	54	

Base con 1 cassetto Art. SLIM.
Single drawer cabinet Art. SLIM.

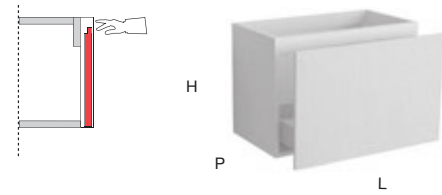

H	P	L
37,5	40	36 - 45 - 54 - 63 - 72 - 90 - 108
50	47	
	54	

BINARIO 03 ▲

art. SMART

Maniglia fresata opzionale.
Optional milled handle.



Fianco fresato
Milled side

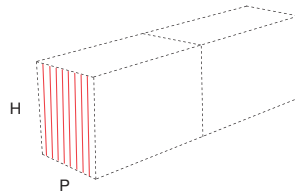

H	P
37,5	40
50	47
	54

Fianco liscio
Smooth side

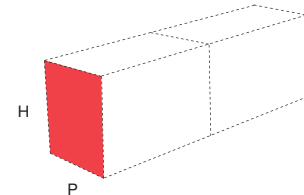

H	P
37,5	40
50	47
	54

BINARIO 12 ▲

Porta lavabo con 1 cassetto Art. SLIM.
Large drawer sink unit Art. SLIM.

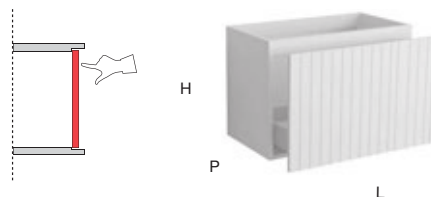

H	P	L
37,5	40	54 - 63 - 72 - 90 - 108
50	47	
	54	

Base con 1 cassetto Art. SLIM.
Single drawer cabinet Art. SLIM.

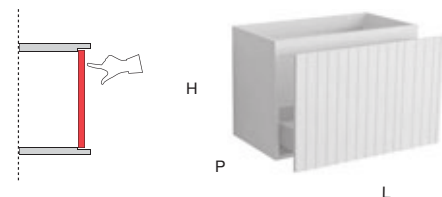

H	P	L
37,5	40	36 - 45 - 54 - 63 - 72 - 90 - 108
50	47	
	54	

BINARIO 12 ▲

ORMA

2019

design_AL Studio

Una collezione pura e senza tempo, un impianto geometrico semplice e una struttura rigorosa ed essenziale impreziosita dalla qualità delle finiture e dei materiali utilizzati, dalla ricercatezza della gamma cromatica, dal tratto identitario della maniglia integrata nell'anta. Orma è una collezione concreta, una serie di mobili realizzati partendo da un "nucleo" in supporto laminato, e da una "pelle" esterna, laccata o in essenza di legno. Una tecnica costruttiva che lascia spazio a numerose possibilità di personalizzazione ed a combinazioni possibili di materia e texture sia per le ante che per le strutture, ma anche di vani a giorno, cassetti e contenitori.

La gola è il tratto saliente della collezione, l'impronta, l'orma appunto. Un segno distintivo, che si rivela univocamente nelle basi collocate alle estremità della composizione per le quali la maniglia è fresata fino a un terzo dell'anta, mentre quella delle basi centrali è fresata per tutta la larghezza. Nasce così una gola continua che si sviluppa lungo tutta la larghezza del mobile e che quando viene aperto conferisce all'insieme un tratto caratteristico che esalta anche l'eccellenza tecnica delle lavorazioni e dei dettagli.

A pure and timeless collection, a simple geometric shape with rigorous and essential structure embellished by the quality of the finishes and materials used. A refined color range and identifying trait of the handle integrated into the door. Orma is a concrete collection, a series of furniture made from a laminated "core", and an external "skin", lacquered or in wood essence. A construction technique that leaves room for numerous custom possibilities and combinations of materials and textures for both the doors and the structures, as well as open compartments, drawers and containers.

The handle is the highlight of the collection, precisely the mark. A distinctive sign, which is revealed in the cabinets placed at the end of the composition for which the handle is milled up to a third of the door, while that of the central cabinets are milled over the entire width. The result is a continuous groove that develops along the entire width of the piece of furniture and when opened gives the whole a characteristic feature that enhances the technical excellence of the workmanship and details.



OFRMA



La composizione L 182,4 cm, P 54 cm, H 37,5 cm, laccata color Pompeiano goffrato, è composta da due fianchi art. OFI54, da una base portalavabo art. OLI290, da due basi art. OBI245 e da un top in Flumood Falena con lavabo integrato art. NUVOLA. Attrezzatura cassetto STRATO con divisori in vetro fumè. Rubinetteria della collezione INDIGO art. ND301 finitura grafite. Specchio art. CIRCUS1108W con illuminazione a led comprensivo di lampada LUCENTE.

The composition L 182,4 cm, D 54 cm, H 37,5 cm, lacquered color embossed Pompeiano, is made up of two side panels art. OFI54, sink unit art. OLI290, two cabinets art. OBI245 and top in Flumood Falena with integrated sink art. NUVOLA. STRATO drawer accessories with fumè glass dividers. INDIGO tap collection art. ND301 in the graphite finish. Mirror art. CIRCUS1108W with LED lighting including LUCENTE lamp.



ORMA



La composizione L 182,4 cm, P 54 cm, H 37,5 cm, laccata color Pompeiano gofrato, è composta da due fianchi art. OFI54, da una base porta lavabo art. OLI290 e da due basi art. OBI245. Il top spessore 1,2 cm art. BC154 è in Flumood Bianco con lavabo in appoggio art. VELORETTO63. Rubinetteria della collezione INDIGO art. ND303 finitura grafite. Lo specchio L 180 cm, H 75 cm è un art. ORMA75W.

The composition L 182,4 cm, D 54 cm, H 37,5 cm, lacquered color embossed Pompeiano, is made up of two side panels art. OFI54, sink unit art. OLI290 and two cabinets art. OBI245. The 12 mm thick top art. BC154 is in white Flumood with top mount sink art. VELORETTO63. INDIGO tap collection art. ND301 in the graphite finish. The mirror L 180 cm, H 75 cm is art. ORMA75W.



La composizione laccata color Pompeiano gofrato L 182,4 cm, P 54 cm, H 37,5 cm è composta da due fianchi art. OFI54 e da due portalavabo art. OLI290; il top spessore 1,2 cm art. BC154 è in Flumood Bianco con lavabi in appoggio art. VELORETTO63. La rubinetteria è della serie INDIGO art. ND303 in finitura grafite. Lo specchio L 180 cm, H 75 cm è un art. ORMA75W.

The composition laquered color embossed Pompeiano L 182,4 cm, D 54 cm, H 37,5 cm is made up of two side panels art. OFI54 and two sink units art. OLI290; the 12 mm thick top art. BC154 is in white Flumood with top mount sinks art. VELORETTO63. The taps are from the INDIGO series, art. ND303 in graphite finish. The mirror L 180 cm, H 75 cm is art. ORMA75W.

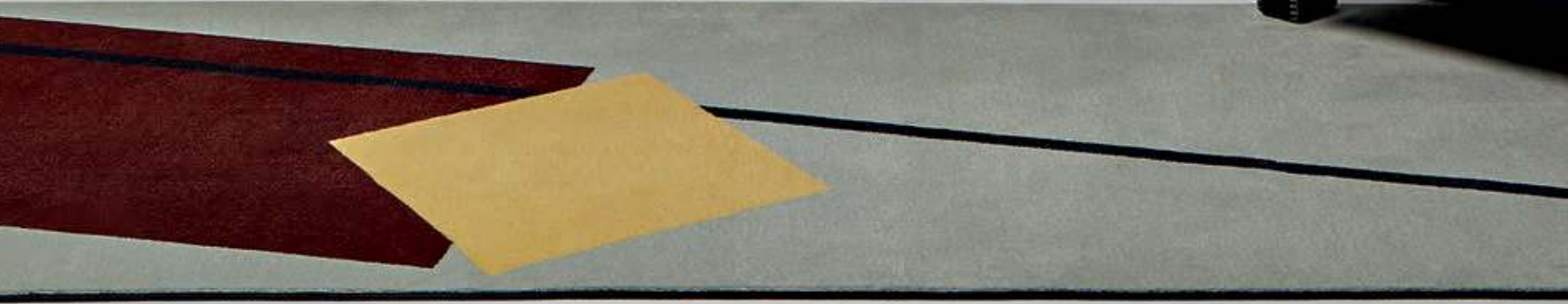



La composizione L 92,4 cm, P 47 cm, H 37,5 cm in Rovere thermo, è composta da due fianchi art. OFI47 e da un porta lavabo art. OLIM290. Il top spessore 1,2 cm Art. BC147 è in Flumood Bianco con lavabo integrato art. NUVOLA. La rubinetteria è della serie INDIGO, erogatore art. ND921 e miscelatore art. ND601 in finitura grafite. Lo specchio L 54 cm, H 75 cm, P 5,4 cm è un art. COLLAGE309, mentre il portasalviette L 72 cm P 8 cm H 3 cm in alluminio finitura Bronzo è un art. PLAY72.

The composition L 92,4 cm, D 47 cm, H 37,5 cm in Rovere thermo, is made up of two side panels Art. OFI47 and a sink unit art. OLIM290. The 1,2 cm thick top art. BC147 is in white Flumood with integrated sink art. NUVOLA. The taps are from the INDIGO series, spout art. ND921 and mixer art. ND601 in graphite finish. The mirror L 54 cm, H 75 cm, D 5,4 cm is art. COLLAGE309, while the towel rail L 72 cm D 8 cm H 3 cm in aluminum Bronze finish is art. PLAY72.



La composizione comprende lo specchio, con illuminazione Led, art. COLLAGE354W L 54 cm H 75 cm P 5,4 cm; rubinetteria INDIGO art. ND920 e art. ND601 in finitura grafite.

Il mobile è composto da un un fianco art. OFI40 e da una base a giorno art. IGI345 entrambi in Rovere thermo, e da un porta lavabo, Art. OLI190, verniciato Ovatta seta con maniglia in Rovere thermo. Il top in Flumood Falena art. BC140, L136,2 cm P 40 cm Sp. 1,2 cm, ospita il lavabo integrato Art. NIDO472, la coppia di bicchieri art. PERCEZIONE ed il vaso in Crismood Fumè art. MASA1. Carta da parati della collezione TRALERIGHE art. O10P e art. A10P. Tappeto della collezione TRAMATO art. TR441 L 200 cm P 85 cm.

The composition is made up of mirror art. COLLAGE354W L 54 cm H 75 cm; INDIGO tap art. ND920 and art. ND601 in graphite finish. The cabinet has one side art. OFI40 and one open cabinet art. IGI345 both in Rovere thermo, sink unit art. OLI190 lacquered silk Ovatta with front panel also in Rovere thermo. The top in Flumood Falena art. BC140 L 136,2 cm D 40 cm and 1,2 cm thick with integrated sink art. NIDO472, pair of glasses art. PERCEZIONE and Crismood vase art. MASA1 in fume. Wallpaper from the TRALERIGHE collection art. O10P and art. A10P. carpet from the TRAMATO collection art. TR441 L 200 cm 85 cm D.







ORMA





OFRWA





Le composizioni entrambe L 137,4 cm, P 47 cm, H 37,5 cm, sono composte da due fianchi art. OFI47 in Rovere thermo come la fascia di battuta e da un portavavabo art. OLIM290 e una base art. OBIM245, con cassetto interno art. SLIM40, entrambi in finitura Vespa gofrato. Il top spessore 1,2 cm art. BC147 è in Flumood Bianco con lavabo integrato art. BASICO47. Attrezzatura cassetti STRATO con divisori in vetro fumè. La rubinetteria è della serie INDIGO art. ND301 in finitura grafite. Gli specchi Ø 108 cm sono art. CIRCUS108W.

Both compositions L 137,4 cm, D 47 cm, H 37,5 cm are made up of two side panels art. OFI47 in Rovere thermo as the front strip and sink unit art. OLIM290 and cabinet art. OBIM245 with internal drawer art. SLIM40 both in embossed Vespa finish. The 1,2 cm thick top art. BC147 is in white Flumood with integrated sink art. BASICO47. STRATO drawer accessories with fumè glass dividers. The taps are of the INDIGO series, art. ND301 in graphite finish. The mirrors Ø108 cm are art. CIRCUS108W.





ORMA

La composizione in Rovere thermo L 136,2 cm, P 47 cm, H 37,5 cm è composta da un fianco art. OFI47, da un porta lavabo art. OLIM290 e una base con due vani a giorno art. IGIM445; il frontale è in finitura Vespa gofrato. Il top spessore 1,2 cm art. BC147 è in Flumood Bianco con lavabo integrato art. BASICO47. La rubinetteria è della serie INDIGO art. ND301 in finitura grafite. Lo specchio L 135 cm, H 75 cm è un art. ORMA75W.

The Rovere thermo composition L 136,2 cm, D 47 cm, H 37,5 cm is made up of one side panel art. OFI47, a sink unit art. OLIM290 and a cabinet with two open compartments art. IGIM445; lacquered front in embossed Vespa finish. The 1,2 cm thick top art. BC147 is in white Flumood with integrated sink art. BASICO47. The taps are of the INDIGO series, art. ND301 in graphite finish. The mirror L 135 cm, H 75 cm is art. ORMA75W.



La composizione in Rovere thermo L 137,4 cm, P 47 cm, H 37,5 cm è composta da due fianchi art. OFI47, da un porta lavabo art. OLIM290 e una base art. OBIM245 con cassetto interno art. SLIM40. Il top spessore 1,2 cm art. BC147 è in Flumood Bianco con lavabo in appoggio art. VELOTONDO45. Attrezzatura cassette STRATO con divisori in vetro fumè. La rubinetteria è della serie INDIGO art. ND303 in finitura grafite. Lo specchio L 135 cm, H 75 cm è art. ORMA75W.

The composition in Rovere thermo L 137,4 cm, P 47 cm H 37,5 cm has two side panels art. OFI47, a sink unit art. OLIM290 and one cabinet art. OBIM245 with internal drawer art. SLIM40. The top 1,2 cm thick is in white Flumood with top mount sink art. VELOTONDO45. Drawer accessories STRATO with fume glass dividers. INDIGO tap series art. ND303 in graphite. The mirror L 135 cm H 75 cm is art. ORMA75W.









art. NIDO54 | L 54 P 47

La composizione in Rovere thermo L 137,4 cm, P 47 cm, H 37,5 cm è formata da due fianchi art. OFI47, da un porta lavabo art. OLIM290 e una base art. OBIM245. Il top spessore 1,2 cm art. BC147 è in Flumood Bianco con lavabo integrato art. NIDO54. La rubinetteria è della serie INDIGO, erogatore art. ND921 e miscelatore art. ND601 in finitura grafite. Lo specchio L 135 cm, H 75 cm è un art. ORMA75W.

The Rovere thermo composition L 137,4 cm, D 47 cm, H 37,5 cm is made up of two side panels Art. OFI47, a sink unit Art. OLIM290 and cabinet Art. OBIM245. The 1,2 cm thick top Art. BC147 is in white Flumood with integrated sink Art. NIDO54. The taps are from the INDIGO series, spout Art. ND921 and mixer Art. ND601 in graphite finish. The mirror L 135 cm, H 75 cm is Art. ORMA75W.



art. NIDO72 | L 54 P 47

La versione con top spessore 1,2 cm art. BC147 è in Flumood Bianco e lavabo integrato art. NIDO72.

Version with 1,2 cm thick top Art. BC147 in white Flumood and integrated sink Art. NIDO72.





La composizione finitura Matita gofrato L 146,4 cm, P 47 cm, H 50 cm è composta da due fianchi art. OFA47, da un porta lavabo art. OLAM272 e una base art. OBAM872; il top spessore 1,2 cm art. BC147 è in Flumood Bianco con lavabo integrato art. NUVOLA. La rubinetteria è della serie INDIGO, erogatore art. ND921 e miscelatore art. ND601 in finitura grafite. Lo specchio L 144 cm, H 75 cm è un art. NEUTRO75W. Il porta salviette L 72 cm P 8 cm H 3 cm in alluminio finitura Bronzo è un art. PLAY72.

The embossed Matita finish composition L 146,4 cm, D 47 cm, H 50 cm is made up of two side panels art. OFA47, a sink unit art. OLAM272 and a cabinet art. OBAM872; the 1,2 cm thick top art. BC147 is in white Flumood with integrated sink art. NUVOLA. The taps are from the INDIGO series, spout Art. ND921 and mixer Art. ND601 in graphite finish. The mirror L 144 cm, H 75 cm is art. NEUTRO75W. The towel rail W 72 cm D 8 cm H 3 cm in aluminum Bronze finish is art. PLAY72.



La composizione in finitura Noce canaletto L 146,4 cm, P 54 cm, H 37,5 cm è formata da due fianchi art. OFI54, da un porta lavabo art. OLI272 e due basi art. OBI236; il top spessore 1,2 cm art. BC154 è in Flumood Bianco con lavabo integrato art. BRECCIA. La rubinetteria è della serie INDIGO art. ND301 in finitura cromo lucido. Lo specchio L 144 cm, H 75 cm è un art. NEUTRO75W.

The composition in Noce canaletto finish L 146,4 cm, D 54 cm, H 37,5 cm is made up of two side panels art. OFI54, a sink unit art. OLI272 and two cabinets art. OBI236; the 1,2 cm thick top art. BC154 is in white Flumood with integrated sink art. BRECCIA. The tap is of the INDIGO series, Art. ND301 in polished chrome finish. The mirror L 144 cm, H 75 cm is art. NEUTRO75W.



ORMA

DOMINO

Sempre alla ricerca della qualità assoluta in ogni singolo dettaglio, anche in quelli apparentemente più nascosti, antoniolupi propone un sistema di divisori per cassetti che associa la massima funzionalità all'eccellenza dei materiali e delle lavorazioni tipiche di ogni prodotto dell'azienda. Chiamati a svolgere un ruolo sempre più importante nella gestione dello spazio interno, questi accessori testimoniano la costante tensione verso la bellezza sotto ogni aspetto.

Always looking for the highest quality in every detail even in the most seemingly hidden. Antoniolupi proposes a dividing system for drawers that combines maximum functionality to the excellence of materials and processes typical of each product of the company. Called upon to play an increasingly important role in the management of the internal space, these accessories testify to the constant tension towards beauty in every aspect.



Sempre alla ricerca
della qualità assoluta

*Always looking for
the highest quality*



Attrezzatura DOMINO in finitura Noce canaletto

Internal accessories DOMINO in Noce canaletto wood finish









La composizione finitura Bianco mood gofrato L 254,4 cm, P 54 cm, H 37,5 cm è composta da due fianchi art. OFI54 e da due porta lavabo art. OLI2108 e una base a giorno in Rovere thermo art. IGI436; il top spessore 1,2 cm art. BC154 è in Flumood Bianco con lavabi in appoggio art. SENSOC in Cristalmood Fumè. La rubinetteria è della serie INDIGO art. ND921 e art. ND601 in finitura grafite. Gli specchi L 72 cm, H 110 cm sono art. ORMA110W. Attrezzatura cassette STRATO con divisori in vetro fumè.

The composition in embossed Bianco mood L 254,4 cm, D 54 cm, H 37,5 cm is made up of two side panels art. OFI54, two sink units art. OLI2108 and an open cabinet in Rovere thermo art. IGI436; the 1,2 cm thick top art. BC154 is in white Flumood with sinks art. SENSOC in Cristalmood Fumè. The taps are from the INDIGO series, art. ND921 and art. ND601 in graphite finish. The mirrors L 72 cm, H 110 cm are art. ORMA110W. STRATO drawer accessories with fumè glass dividers.







La composizione finitura Bianco mood gofrato L 218,4 cm, P 54 cm, H 37,5 cm è composta da due fianchi art. OFI54 e da due porta lavabo art. OLI2108; il top spessore 1,2 cm art. BC154 è in Flumood Bianco con lavabi integrati art. NIDO72. La rubinetteria è della serie INDIGO art. ND301 in finitura cromo lucido. Gli specchi L 72 cm, H 110 cm sono art. ORMA110W. Attrezzatura cassetti STRATO con divisori in vetro fumè.

The composition with embossed Bianco mood finish L 218,4 cm, D 54 cm, H 37,5 cm is made up of two side panels art. OFI54 and two sink units art. OLI2108; the 1,2 cm thick top art. BC154 is in white Flumood with integrated sinks art. NIDO72. The taps are from the INDIGO series, art. ND301 in polished chrome finish. The mirrors L 72 cm, H 110 cm are art. ORMA110W. STRATO drawer accessories with fumè glass dividers.

ORMA FINITURE - FINISHES

La fascia ha la stessa finitura del fianco.

The front panel has the same finish as the side panels.

A



Bianco lucido/colorato opaco o goffrato, come da nostro campionario colori



Glossy white/Matt lacquered or embossed, as per our colour samples

D



Colorato lucido/finitura seta, come da nostro campionario colori



Glossy lacquered/Silk finish, as per our colour samples

O

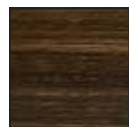

Rovere: sbiancato, naturale castano, moro, grigio, matita, ardesia, thermo.

Noce: canadese, visone, canaletto.

ORMA MANIGLIE - HANDLES

TIPOLOGIE DI MANIGLIE | TYPE OF HANDLES

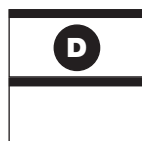
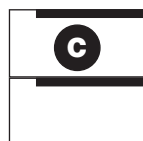
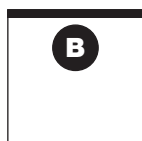
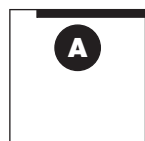

ESEMPI DI COMBINAZIONI MANIGLIE | EXAMPLES OF HANDLE COMBINATIONS

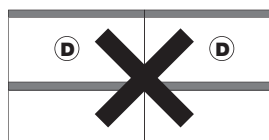
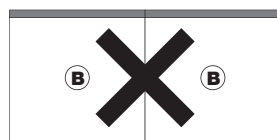
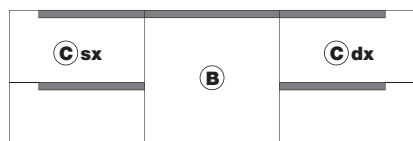
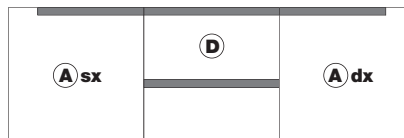
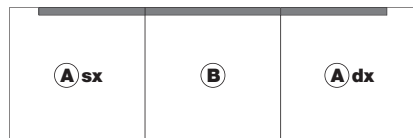
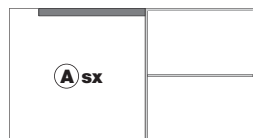
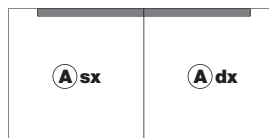
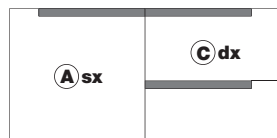

NO | NO

NO | NO

Fianco da aggiungere a dx e sx della composizione, formata da uno o più componenti.

Side panel to add on to the right and left of each composition made up of one or more components.

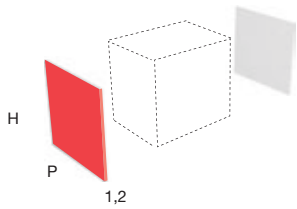

H	P
25	40
37,5	47
50	54

Base con 1 vano a giorno.

Open cabinet with 1 compartment.

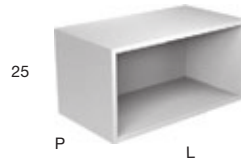

H	P	L
25	40	36 - 45 - 54 - 72
	47	
	54	

Base con 2 vani a giorno.

Open cabinet with 2 compartments.

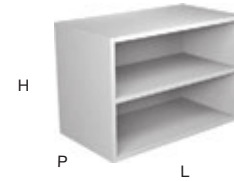

H	P	L
37,5	40	36 - 45
50	47	
	54	

Porta lavabo con 1 cassetto Art. SLIM ed il fondo sagomato internamente per sifone.

Sink unit with 1 drawer Art. SLIM and bottom shaped internally for siphon.

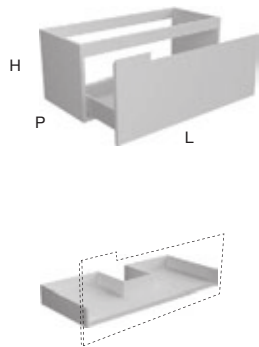

H	P	L
25	40	54 - 63 - 72 - 90 - 108 - 126
37,5	47	
	54	

Porta lavabo con 1 cassetto Art. SLIM.

Large drawer sink unit Art. SLIM.

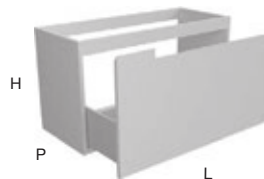

H	P	L
37,5	40	54 - 63 - 72 - 90 - 108 - 126
50	47	
	54	

Porta lavabo con fascia centrale, superiore e 2 cassetti Art. SLIM di cui 1 sagomato internamente per sifone.

Double drawer sink unit Art. SLIM, one of which internally shaped for siphon, middle and upper front panel.

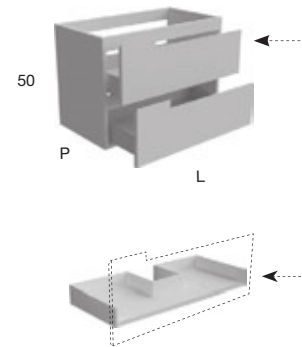

H	P	L
50	40	54 - 63 - 72 - 90 - 108 - 126
	47	
	54	

Base con 1 cassetto Art. SLIM.

Single drawer cabinet Art. SLIM.



H	P	L
25	40	36 - 45 - 54 - 63 - 72 - 90 - 108 - 126
	47	
	54	

Base con 1 cassetto Art. SLIM.

Single drawer cabinet Art. SLIM.

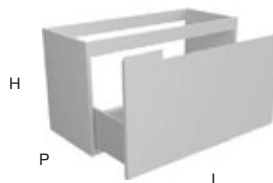

H	P	L
37,5	40	36 - 45 - 54 - 63 - 72 - 90 - 108 - 126
50	47	
	54	

Base con 2 cassetti Art. SLIM.

Double drawer cabinet Art. SLIM.

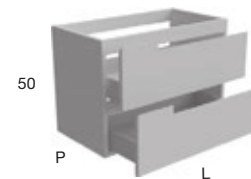

H	P	L
50	40	36 - 45 - 54 - 63 - 72 - 90 - 108 - 126
	47	
	54	

FIANCHI E BASI | SIDES AND CABINETS

PORTA LAVABI | SINK UNITS

BASI | CABINET

ILBAGNO

2014

design_Roberto Lazzeroni

Un progetto dedicato a un'area di gusto molto sofisticata, una rilettura rispettosa delle forme classiche che si traduce in elementi dalle linee morbide ed eleganti. Una collezione fortemente emozionale caratterizzata dalla matericità delle essenze del legno, dal sapiente uso dei laccati, dal gusto retrò degli specchi, dai riflessi dei metalli: Ilbagno racconta nuovi orizzonti, descrive atmosfere intime e ricercate, è un ritorno alle origini, un progetto che guarda al passato per esplorare il futuro.

Una collezione per un bagno borghese, romantico, una proposta meno rigorosa e minimale che consente di recuperare la memoria di immagini conosciute, gli stilemi di un nobile passato, le suggestioni che vengono da stili diversi. Un'operazione non nostalgica ma quanto mai attuale, una rielaborazione di contenuti ottenuta attraverso la pulizia e lo stile propri di antoniolupi, la cura maniacale dei dettagli, l'eccellenza delle lavorazioni e dei materiali utilizzati.

Mobili, consolle, applique, specchi, accessori, vasche, un vero e proprio progetto di arredo, una collezione fortemente emozionale che, con la matericità delle essenze del legno e il sapiente uso del colore laccato, crea atmosfere intime e ricercate. E' caratterizzata infatti da componenti differenti tra loro per materiali ed estetica, accomunati però da un'unica filosofia che identifica il progetto grazie al gusto romantico di tutti gli elementi; una sofisticata rilettura di forme classiche e di design dalle linee eleganti e morbide.

A project dedicated to an area of very sophisticated taste, a respectful reinterpretation of classical forms that results in elements with soft and elegant lines.

A highly emotional collection characterized by the material nature of the woods, by the skillful lacquering, retro style of the mirrors and the metal reflections: Ilbagno describes an intimate and refined atmosphere with a return to origins, a project that looks to the past to explore the future.

A collection for a middle-class bathroom, romantic, a proposal less rigorous and minimal which allows you to recover the memory of familiar images, the style of a noble past, the suggestions that come from different styles. Not nostalgic but rather current, a reworking of content obtained through the antoniolupi style almost maniacal attention to detail, the excellence of the workmanship and materials used.

Furniture, consoles, wall lamps, mirrors, accessories, tubs, a real design project, a highly emotional collection with the material nature of wood and the wise use of lacquered color, create an intimate and refined atmosphere. And in fact it's characterized by different components in the material and aesthetic aspects, but united by a single philosophy that identifies the project thanks to the romantic taste of all the elements; a sophisticated reinterpretation of classic forms and design with elegant and soft lines.

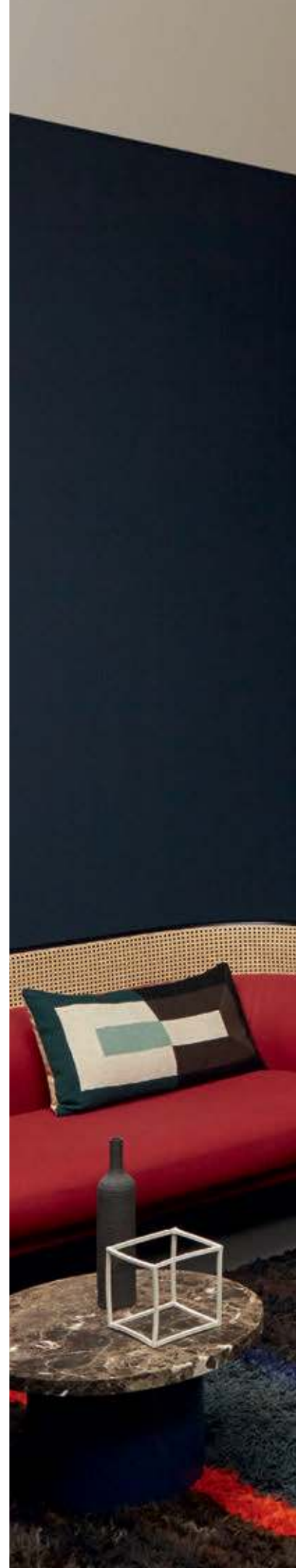





Console in Frassino Moka L 108 cm, P 54 cm, H 83,5 cm, art. ACCORDO108, abbinata al top in vetro con lavabo integrato laccato acidato Blu navy art. ACCORDO3108. Rubinetteria TIMBRO art. TB230 finitura cromo lucido. A parete gli specchi sono art. LUXOR875 L 75 cm, H 75 cm, con cornice in vetro bronzo. Completano la composizione tre lampade a led art. RONDO1.

Console in Frassino Moka L 108 cm, D 54 cm, H 83,5 cm, art. ACCORDO108, combinata con top in vetro e lavabo integrato laccato Blu navy art. ACCORDO3108. La foto a destra ha una console in Noce Americano, lo specchio art. LUXOR775 L 75 cm, H 75 cm con vetro bronzo.





Console in Frassino Moka L 108 cm, P 54 cm, H 83,5 cm, art. ACCORDO108, abbinata al top in vetro con lavabo integrato laccato Nero lucido art. ACCORDO2108. Nella foto a destra la console è in Noce Americano, lo specchio è un art. LUXOR775 L 75 cm, H 75 cm, con cornice in vetro bronzo.

Console in Frassino Moka L 108 cm, D 54 cm, H 83,5 cm, art. ACCORDO108, combined with glass top and integrated sink lacquered Nero art. ACCORDO2108. The picture on the right has a console in Noce Americano, the mirror art. LUXOR775 L 75 cm, H 75 cm with bronze glass.





Consolle in massello Noce Americano, art. ACCORDO180, abbinata al top in Flumood Bianco con lavabi integrati art. ACCORDOM1180. Gli specchi art. FORMA54 di L 54 cm e H 85 cm, hanno una cornice in legno massello Noce Americano. Lampade in vetro bronzo soffiato art. RONDO1.

Solid Noce Americano console art. ACCORDO180 combined with top in white Flumood and integrated sink art. ACCORDOM1180. The mirrors art. FORMA54 L 54 cm and H 85 cm have a frame in solid Noce Americano. Lamps in bronze colored blown glass art. RONDO1.





Console in massello Frassino Moka, art. ACCORDO180M, abbinata al top in Flumood Bianco con lavabi integrati art. ACCORDOM1180. Gli specchi art. FORMA54 di L 54 cm e H 85 cm, hanno una cornice in legno massello Frassino Moka, sono illuminati dalle lampade in vetro bronzo soffiato art. RONDO1.

Console in solid Frassino Moka art. ACCORDO180M is combined with a white Flumood top and integrated sinks art. ACCORDOM1180. The mirrors art. FORMA54 L 54 cm and H 85 cm have a solid Frassino Moka frame, they are illuminated by lamps in blown glass art. RONDO1. The tap is from the TIMBRO collection in polished chrome art. TB230 and MICRO siphon also in polished chrome.







ILBAGNO





Il mobile laccato color Havana lucido, è composto da un basamento in Frassino Moka comprensivo di fianchi art. PIANO154, da due basi art. GBB236 L 36 cm, da un porta lavabo art. GBL272 L 72 cm e da un top in marmo Calacatta Oro art. TEMPO354 L 162 cm; il lavabo sopra piano è in Flumood Bianco art. BOLOMOOD63. Lo specchio, con cornice in vetro argentato fumè art. LUXOR9126 di L 126 cm e H 75 cm è illuminato dalle lampade in vetro bronzo soffiato art. RONDO1.

The furniture lacquered glossy Havana is made up of a base in Frassino Moka inclusive of sides art. PIANO154, two cabinets art. GBB236 L 36 cm, one sink unit art. GBL272 L.72 cm, and a top in marble Calacatta Oro art. TEMPO354; top mount sink in white Flumood art. BOLOMOOD63. The mirror with silvered fumè glass art. LUXOR9126, L 126 cm and H 75 cm illuminated by two lamps in blown glass art. RONDO1.









Il mobile laccato Biancospino lucido è composto da un basamento in Noce Americano art. ALLEGRO254, H 45,5 cm, P 54 cm, da due fianchi art. GIF454 L 18 cm, da due basi art. GIB236 L 36 cm, da un porta lavabo art. GIL272, L 72 cm e da un top con lavabo integrato in Flumood Bianco art. TEMPOM72. L'intera composizione è H 84 cm P 54 cm. Lo specchio ha la cornice in vetro argentato rosè art. LUXOR790 L 90 cm e H 90 cm.

The glossy lacquered cabinet in color Biancospino is made up of a base in Noce Americano art. ALLEGRO254, H 45,5 cm, P 54 cm, two side panels art. GIF454 L 18 cm, two cabinets art. GIB236 L 36 cm, sink unit art. GIL272 L 72 cm and a top with integrated sink in white Flumood art. TEMPOM72. The entire composition is H 84 cm D 54 cm. The mirror in rosè silvered glass frame art. LUXOR790 L 90 cm and H 90 cm.



Il mobile laccato Grigio smog opaco è composto da una coppia di fianchi art. GIF454 L 18 cm, da due basi art. GIB236 L 36 cm, da un porta lavabo art. GIL272, L 72 cm e da un top in vetro Grigio smog acidato art. TEMPO254 L 180 cm, P 54, spessore 1,2 cm; il lavabo sopra piano è in Flumood Bianco art. BOLOMOOD54. Lo specchio con cornice in vetro argentato fumè è l'art. LUXOR10117, L 117 cm e H 80 cm. Su richiesta è possibile inserire cassetti art. WOOD in Noce Americano.

The cabinet lacquered in matt Grigio smog and made up of a pair of side panels art. GIF454 L 18 cm, two cabinets art. GIB236 L 36 cm, sink unit art. GIL272 L 72 cm and acid etched glass Grigio smog art. TEMPO254 L 180 cm, D 54, thickness 1,2 cm. Top mount sink in white Flumood art. BOLOMOOD54. Mirror with smoked glass art. LUXOR10117, L 117 cm H 80 cm. Upon request possible to include drawers art. WOOD in Noce Americano finish.





Il mobile laccato Blu Navy lucido, è composto da un basamento in Frassino Moka comprensivo di fianchi art. PIANO1254, da due porta lavabi art. GIL272 L 72 cm e da una base art. GIB236. Top in marmo Petra Ruja art. TEMPO354 L 198 cm, lavabo sopra piano in Flumood Bianco art. BOLOMOOD63. Lo specchio, con cornice in vetro argentato bronzo art. LUXOR775 di L 75 cm e H 75 cm è illuminato dalle lampade in vetro bronzo soffiato art. RONDO1.

The furniture lacquered glossy Blu Navy is made up of a base in Frassino Moka inclusive of sides art. PIANO1254, two sink units art. GIL272 L 72 cm and one cabinet art. GIB236. Top in marble Petra Ruja art. TEMPO354 L 198 cm with topmount sink in white Flumood art. BOLOMOOD63. The mirror with silvered bronze glass art. LUXOR775 L 75 cm and H 75 cm is illuminated by lamps in blown glass art. RONDO1.







Il mobile sospeso laccato Tortora lucido, è composto da una cornice in Noce Americano art. ADAGIO54, da due fianchi art. GIF454 L 18 cm, da due basi art. GIB236 L 36 cm, da un porta lavabo art. GIL272 L 72 cm e da un top con lavabo integrato in Flumood Bianco art. TEMPOM72. Lo specchio orizzontale o verticale, con cornice in vetro argentato rosè art. LUXOR9117, L 117 cm, H 75 cm, è illuminato dalle lampade in vetro soffiato color bronzo art. RONDO1. A sinistra, un particolare del top in marmo Calacatta Oro art. TEMPO354 su cui poggia il lavabo in Flumood Bianco art. BOLOMOOD63. Il cassetto è in Noce Americano H 18 cm art. WOOD1854.

Suspended cabinet lacquered glossy Tortora made up of a frame in Noce Americano art. ADAGIO54, two side panels art. GIF454 L 18 cm, two cabinets art. GIB236 L 36 cm, sink unit art. GIL272 L 72 cm and a white Flumood top with integrated sink art. TEMPOM72. The mirror can be mounted horizontal or vertical and has a frame in rose silvered glass art. LUXOR9117, L 117 cm and H 75 cm lit by lamps in bronze colored blown glass art. RONDO1. To the left a detail of the marble top in Calacatta Oro art. TEMPO354 with a top mount sink in white Flumood art. BOLOMOOD63. The drawer in Noce Americano H 18 cm art. WOOD1854.



Nella composizione a destra, il mobile laccato Tortora lucido è composto da un basamento in Frassino Moka art. ALLEGRO254, H 45,5 cm, P 54 cm, da due fianchi art. GIF454 L 18 cm, da due basi art. GIB236 L 36 cm, da un porta lavabo art. GIL272, L 72 cm e da un top con lavabo integrato in Flumood Bianco art. TEMPOM72. L'intera composizione è H 84,4 cm, L 180 cm e P 54 cm. Lo specchio con cornice in vetro argentato rosè art. LUXOR790 L 90 cm e H 90 cm è illuminato dalle lampade art. RONDO1.

The composition on the right is lacquered glossy Tortora made up of a base in Frassino Moka art. ALLEGRO254, H 45,5 cm, P 54 cm, two side panels art. GIF454 L 18 cm, two cabinets art. GIB236 L 36 cm, sink unit art. GIL272 L 72 cm and a top with integrated sink in white Flumood art. TEMPOM72. The entire composition is H 84,4 cm, L 180 cm and D 54 cm. The mirror with rosè silvered glass frame art. LUXOR790 L 90 cm and H 90 cm is lit by lamps art. RONDO1.





Il mobile laccato Grigio smog opaco è composto da un basamento in Noce Americano art. ALLEGRO154, H 33 cm, P 54 cm, da due fianchi art. GIF454 L 18 cm, da due basi art. GIB236 L 36 cm, da un porta lavabo art. GIL272, L 72 cm e da un top in marmo Petra Ruja art. TEMPO354; il lavabo sopra piano è in Flumood Bianco art. BOLOMOOD63. Lo specchio, con cornice in vetro argentato fumé art. LUXOR10126 di L 126 cm e H 80 cm è illuminato dalle lampade in vetro bronzo soffiato art. RONDO1.

The furniture lacquered matt Grigio Smog is made up of a base in Noce Americano art. ALLEGRO154, H 33 cm, D 54 cm, two sides art. GIF454 L 18 cm, two cabinets art. GIB236 L 36 cm, one sink unit art. GIL272, L 72 cm and a top in marble Petra Ruja art. TEMPO354; the top mount sink in white Flumood art. BOLOMOOD63. The mirror has a frame in silvered fumé glass art. LUXOR10126 di L 126 cm and H 80 cm illuminated by two lamps in blown glass art. RONDO1.







Il mobile laccato Strada lucido, è composto da un basamento in Noce Americano art. ALLEGRO154, da due fianchi art. GAF354 L 18 cm, da due basi art. GAB236 L 36 cm, da un porta lavabo art. GAL372 L 72 cm e da un top in marmo Petra Ruja art. TEMPO354; il lavabo sottopiano è in Flumood Bianco art. RETTOMOOD3. Lo specchio, con cornice in vetro argentato rosè art. LUXOR890 di L 90 cm e H 90 cm. A sinistra, particolare del cassetto art. WOOD1854 H 18 cm.

The cabinet lacquered glossy Strada is made up of a structure in Noce Americano art. ALLEGRO154, two side panels art. GAF354 L 18 cm, two cabinets art. GAB236 L 36 cm, sink unit art. GAL372 L 72 cm and a marble top in Pietra Ruja art. TEMPO354; the undermount sink is in white Flumood art. RETTOMOOD63. The mirror has a frame in rose silvered glass art. LUXOR890 L 90 cm and H 90 cm.

To the left a detail of the wooden drawer art. WOOD1854 H 18 cm.









I mobili della misura complessiva di L 108 cm ciascuno, sono realizzati nel colore a campione Cobalto lucido. Ogni mobile è composto da un basamento in massello Noce Americano comprensivo di fianchi art. PIANO154, da un porta lavabo art. GBL290 L 90 cm, da un top in vetro laccato a campione Cobalto lucido art. PAUSA254, il lavabo sopra piano è in Flumood Bianco art. BOLOMOOD45. Lo specchio, con cornice in vetro argentato fumè art. LUXOR890 di L 90 cm e H 90 cm è illuminato dalle lampade in vetro bronzo soffiato art. RONDO1.

The furniture measuring L 108 cm overall are made in the glossy sample color Cobalto. Each furniture is made up of a base in Noce Americano inclusive of two side panels art. PIANO154, sink unit art. GBL290 L 90 cm, a glass top lacquered sample color Cobalto art. PAUSA254, the top mount sink in white Flumood art. BOLOMOOD45. The mirror has a frame in fume silvered glass art. LUXO890 L 90 cm and H 90 cm and is lit by lamps in bronze colored blown glass art. RONDO1.



Il mobile realizzato nel colore a campione Cobalto lucido, è composto da un basamento in massello Noce Americano comprensivo di fianchi art. PIANO254, da due basi art. GIB236, L 36 cm, da un porta lavabo art. GIL272 L 72 cm e da un top con lavabo integrato in Flumood Bianco, art. TEMPOM72 di L 162 cm. Lo specchio orizzontale o verticale con cornice in vetro argentato blu art. LUXOR9126, L 126 cm e H 75 cm.

The cabinet lacquered with a sample color glossy Cobalto is made up of a base in Noce Americano inclusive two side panels art. PIANO154, two cabinets art. GIB236 L 36 cm, sink unit art. GIL272 L 72 cm and a white Flumood top with integrated sink art. TEMPOM72 L 162 cm. The mirror, mounted horizontal or vertical, with frame in blu silvered glass art. LUXO9126 L 126 cm and H 75 cm.



ILBAGNO LEGENDA - KEY

Gli elementi di questa collezione sono verniciati internamente ed esternamente.

The elements of this collection are lacquered both internally and externally.

A



Bianco lucido/colorato opaco o gofrato, come da nostro campionario colori

Glossy white/Matt lacquered or embossed, as per our colour samples



D



Colorato lucido/finitura seta, come da nostro campionario colori

Glossy lacquered/Silk finish, as per our colour samples



In fase di ordine indicare il tipo di composizione scegliendo la lettera di riferimento (A1,B1,C1). La composizione dovrà essere completata con top di finitura e lavabi a scelta. Di seguito troverete un esempio esplicativo di come ordinare un mobile appartenente alla soluzione A1.

When ordering indicate the type of composition by choosing the corresponding reference (A1,B1,C1). The composition must be completed with a finishing top and sink of choice. Following is an example of how to order a configuration referenced A1.

ESEMPIO MOBILE DA ORDINARE | EXAMPLE OF CONFIGURATION TO ORDER

A1 SOLUZIONE | CONFIGURATION

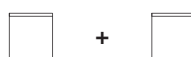
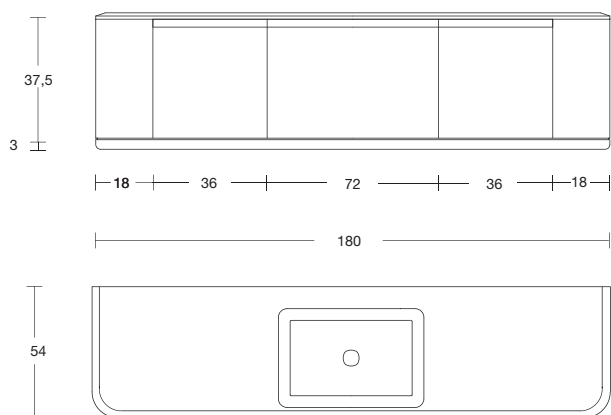

N° 2 ART. GIB236 L 36

Base con 1 cassetto
Cabinet with 1 drawer

+



ART. GIL272 L 72

PortLavabo con 1 cassetto
Sink unit with 1 drawer

+



ART. GIF454

Coppia di fianchi con 1 anta e 1 ripiano interno
Pair of side panels with 1 door and 1 inner shelf

+



ART. ADAGIO54 L 180

Cornice di finitura
Finishing frame

+



ART. TEMPOM72 L 180

Top con lavabo integrato
Top with integrated sink

SOLUZIONI CON UNO O DUE PORTALAVABI E FIANCHI DI 18 CM | CONFIGURATIONS WITH ONE OR TWO SINK UNITS AND SIDE PANELS 18 CM

B1

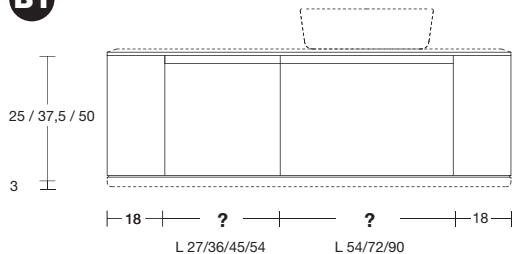

Base con 1 cassetto
Cabinet with 1 drawer



+

PortLavabo con 1 cassetto
Sink unit with 1 drawer



+

Coppia di fianchi a giorno o con 1 anta
Pair of side panels open or with 1 door



C1

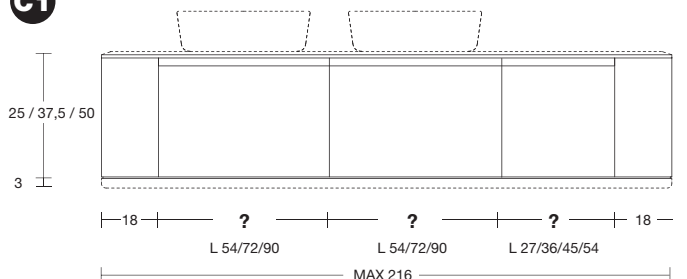

PortLavabo con 1 cassetto
Sink unit with 1 drawer



+

PortLavabo con 1 cassetto
Sink unit with 1 drawer



+

Base con 1 cassetto
Cabinet with 1 drawer



+

Coppia di fianchi a giorno o con 1 anta
Pair of side panels open or with 1 door

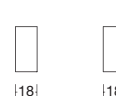

ILBAGNO LEGENDA - KEY

In fase di ordine indicare il tipo di composizione scegliendo la lettera di riferimento (**A2, B2, C2**). La composizione dovrà essere completata con top di finitura e lavabi a scelta. Di seguito troverete un esempio esplicativo di come ordinare un mobile appartenente alla soluzione **A2**.

When ordering indicate the type of composition by choosing the corresponding reference (**A2, B2, C2**). The composition must be completed with a finishing top and sink of choice. Following is an example of how to order a configuration referenced **A2**.

ESEMPIO MOBILE DA ORDINARE | EXAMPLE OF CONFIGURATION TO ORDER

A2 SOLUZIONE | CONFIGURATION

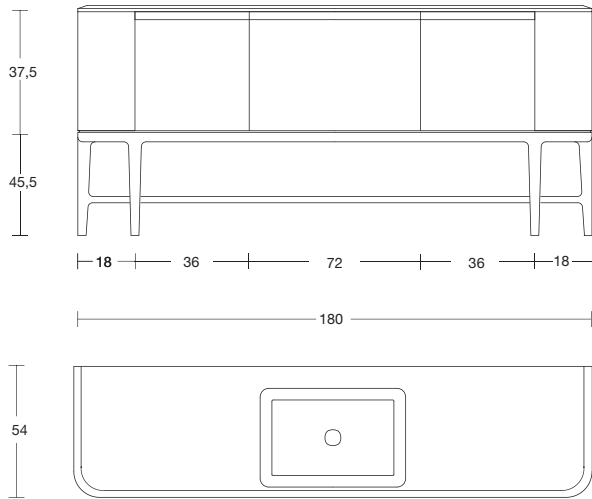

N° 2 ART. GIB236 L 36

Base con 1 cassetto
Cabinet with 1 drawer

+



ART. GIL272 L 72

Portlavabo con 1 cassetto
Sink unit with 1 drawer

+



ART. GIF454

Coppia di fianchi con 1 anta e 1 ripiano interno
Pair of side panels with 1 door and 1 inner shelf

+



ART. ALLEGRO254 L 180

Basamento
Base

+



ART. TEMPOM72 L 180

Top con lavabo integrato
Top with integrated sink

SOLUZIONI CON UNO O DUE PORTALAVABI E FIANCHI DI 18 CM | CONFIGURATIONS WITH ONE OR TWO SINK UNIT AND SIDE PANELS 18 CM

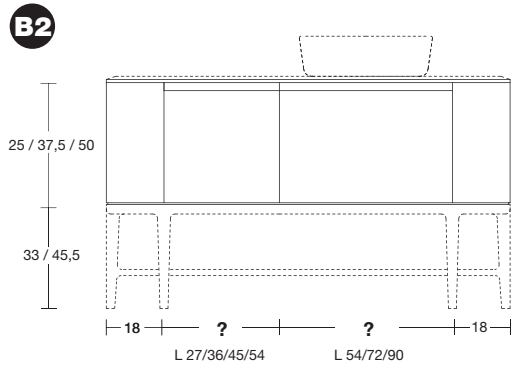

Base con 1 cassetto
Cabinet with 1 drawer



+

Portlavabo con 1 cassetto
Sink unit with 1 drawer



+

Coppia di fianchi a giorno o con
1 anta
Pair of side panels open or with
1 door

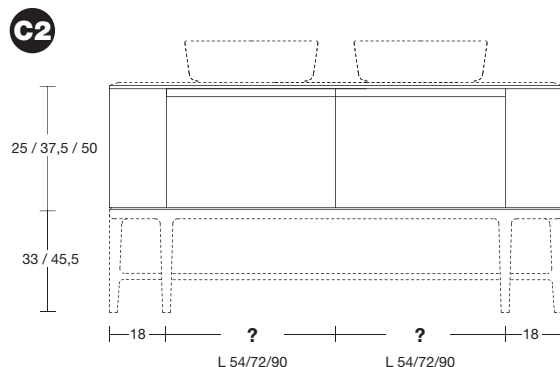

Portlavabo con 1 cassetto
Sink unit with 1 drawer



+

Portlavabo con 1 cassetto
Sink unit with 1 drawer



+

Coppia di fianchi a giorno o con
1 anta
Pair of side panels open or with
1 door



ILBAGNO LEGENDA - KEY

In fase di ordine indicare il tipo di composizione scegliendo la lettera di riferimento (**A3,B3,C3**). La composizione dovrà essere completata con top di finitura e lavabi a scelta. Di seguito troverete un esempio esplicativo di come ordinare un mobile appartenente alla soluzione **A3**.

When ordering indicate the type of composition by choosing the corresponding reference (**A3,B3,C3**). The composition must be completed with a finishing top and sink of choice. Following is an example of how to order a configuration referenced **A3**.

ESEMPIO MOBILE DA ORDINARE | EXAMPLE OF CONFIGURATION TO ORDER

A3 SOLUZIONE | CONFIGURATION

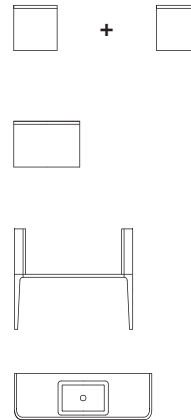
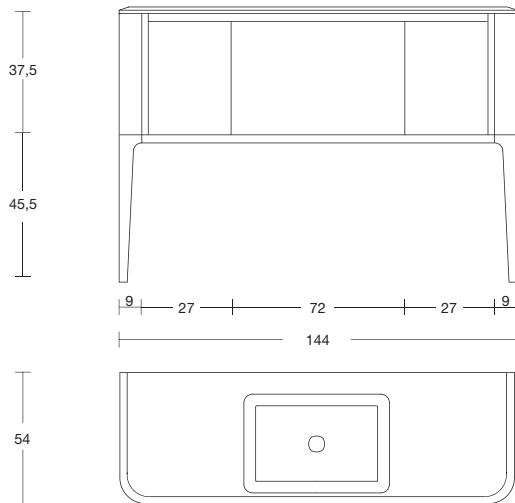

N° 2 ART. GIB227 L 27

Base con 1 cassetto
Cabinet with 1 drawer

+

ART. GIL272 L 72

Portalavabo con 1 cassetto
Sink unit with 1 drawer

+

ART. PIANO254 L 144

Basamento comprensivo di fianchi
Base complete with side panels

+

ART. TEMPOM72 L 144

Top con lavabo integrato
Top with integrated sink

SOLUZIONI CON UNO O DUE PORTALAVABI E FIANCHI DI 18 CM | CONFIGURATIONS WITH ONE OR TWO SINK UNITS AND SIDE PANELS 18 CM

B3

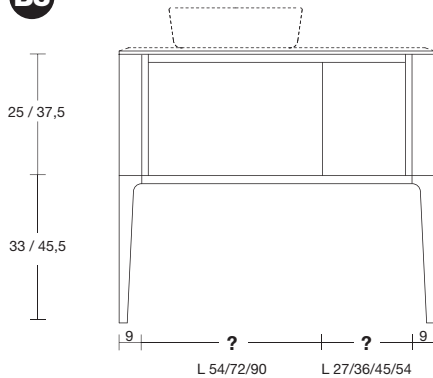

Portalavabo con 1 cassetto
Sink unit with 1 drawer



+

Base con 1 cassetto
Cabinet with 1 drawer



+

Basamento comprensivo di
fianchi
Base complete with side panels

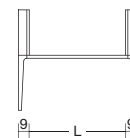

C3

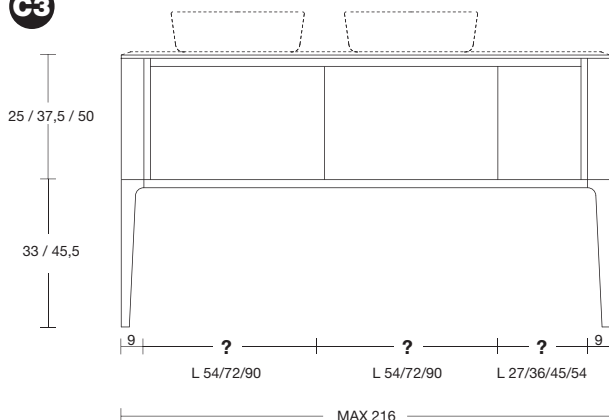

Portalavabo con 1 cassetto
Sink unit with 1 drawer



+

Portalavabo con 1 cassetto
Sink unit with 1 drawer



+

Base con 1 cassetto
Cabinet with 1 drawer



+

Basamento comprensivo di
fianchi
Base complete with side panels

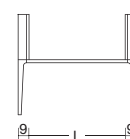

Basamento in massello di legno con livellatore comprensivo di fianchi in legno laccato.

Base in solid wood with levelers complete with wood lacquered side panels.

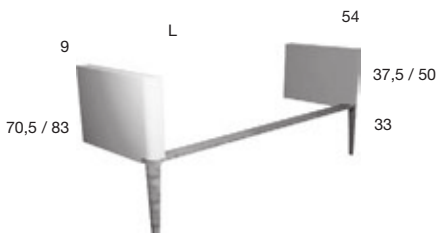

H	P	L
70,5	37,5	54 da / from 72
47,5	50	a / to 216

Basamento in massello di legno con livellatore comprensivo di fianchi in legno laccato.

Base in solid wood with levelers complete with wood lacquered side panels.

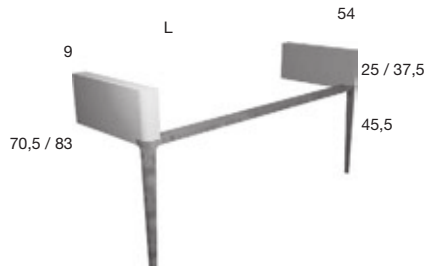

H	P	L
70,5	37,5	54 da / from 72
47,5	50	a / to 216

Piede in massello di legno con livellatore.

Solid wood foot with leveler.



H	P	L
33	20	5
45,5		

BASAMENTI E PIEDI / BASES AND FEET

Cornice di finitura in massello di legno per soluzioni sospese.

Finishing frame in solid wood for suspended compositions.



H	P	L
3	54	da / from 90 a / to 216

Basamento in massello di legno con livellatore.

Base in solid wood with levelers.



H	P	L
33	54	da / from 90 a / to 216

Basamento in massello di legno con livellatore.

Base in solid wood with levelers.



H	P	L
45,5	54	da / from 90 a / to 216

BASAMENTI / BASES

Coppia di fianchi a giorno.

Pair of open side panels.



H	P	L
25	54	18 + 18

Coppia di fianchi a giorno con 1 ripiano.

Pair of open side panels with 1 shelf.

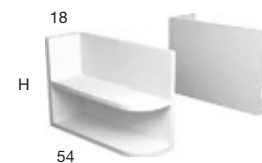

H	P	L
37,5	54	18 + 18
50		

FIANCHI / SIDES

ILBAGNO COMPONENTI - COMPONENTS

FIANCHI E COLONNE / SIDES AND HIGH CABINETS

Coppia di fianchi con 1 anta.
Pair of side panels with 1 door.



H	P	L
25	54	18 + 18

Coppia di fianchi con 1 anta e 1 ripiano interno.
Pair of side panels with 1 door and 1 internal shelf.

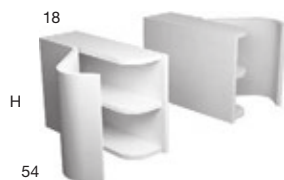

H	P	L
37,5	54	18 + 18
50		

Colonna a giorno con struttura in massello di legno, e 5 ripiani in vetro bronzato spess. 8 mm, completa di fissaggio a parete.
Freestanding open high cabinet in solid wood with 5 bronzed glass shelves 8 mm thick and wall fixings.



H	P	L
154	25	36

PORTA LAVABI E BASI | SINK UNITS AND CABINETS

Porta lavabo laccato con 1 cassetto Art. SLIM.
Lacquered sink unit with 1 drawer Art. SLIM.

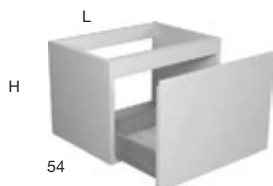

H	P	L
25	54	54 - 72 - 90
37,5		
50		

Porta lavabo laccato predisposto solo per lavabo sottopiano con 1 cassetto Art. SLIM.
Lacquered sink unit prepared for undermount sink with 1 drawer Art. SLIM.

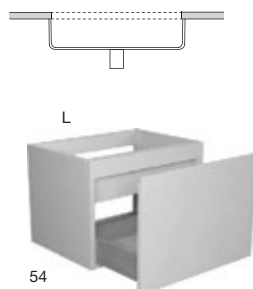

H	P	L
37,5	54	72 - 90
50		

Base laccata con 1 cassetto Art. SLIM.
Lacquered cabinet with 1 drawer Art. SLIM.

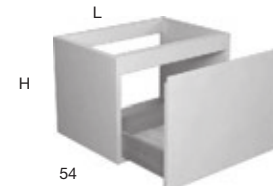

H	P	L
25	54	27 - 36 - 45 - 54
37,5		
50		

CONSOLLE E TOP | CONSOLE AND TOP

Consolle in massello di legno.
Console in solid wood.



H	P	L
83,5	54	90 - 108

Consolle in massello di legno con ripiano.
Console in solid wood with shelf.



H	P	L
83,5	54	90 - 108

Top con lavabo integrato ovale in vetro spess. 12 mm, completo di piletta con scarico libero e raccordo per sifone.
Glass top with integrated oval sink 12 mm thick, complete with open plug and drain pipe fitting.

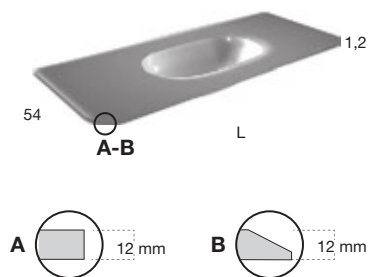

H	P	L
1,2	54	90 - 108

Consolle in massello di legno.
Console in solid wood.



H P L
 83,5 54 180

Consolle in massello di legno con ripiano.
Console in solid wood with shelf.



H P L
 83,5 54 180

Top con lavabo integrato ovale in vetro spess. 12 mm, completo di piletta con scarico libero e raccordo per sifone.
Glass top with integrated oval sink 12 mm thick, complete with open plug and drain pipe fitting.

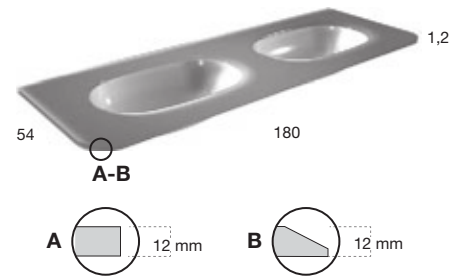

H P L
 1,2 54 180

CONSOLLE E TOP | CONSOLE AND TOP ▲

Top in Flumood o Colormood.
Flumood or Colormood top.

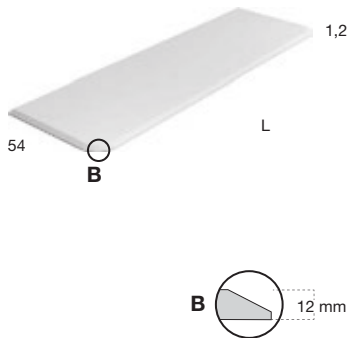

H P L
 1,2 54 da / from 72 a / to 216

Top in vetro temperato a filo piatto o con smusso.
Tempered glass top with polished or bevelled edge.

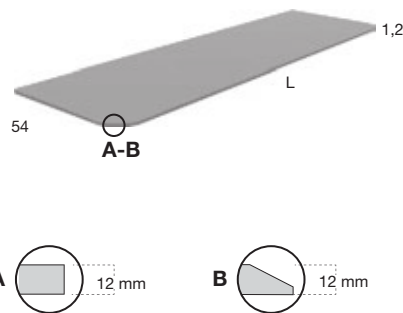

H P L
 1,2 54 da / from 72 a / to 216

Top in marmo.
Marble top.

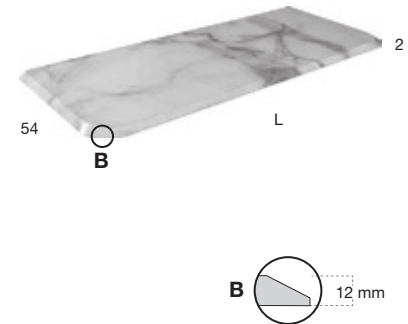

H P L
 2 54 da / from 72 a / to 216

TOP ▲

Top con lavabo integrato sopra piano in Flumood o Colormood, completo di piletta con scarico libero e raccordo per sifone.
Top with integrated sink in Flumood or Colormood, complete with drain pipe fitting and open plug.

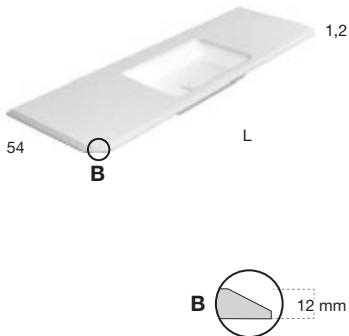

H P L
 1,2 54 da / from 90 a / to 216

Top con doppio lavabo integrato sopra piano in Flumood o Colormood, completo di piletta con scarico libero e raccordo per sifone.
Top with double integrated sink in Flumood or Colormood complete with drain pipe fitting and plug.

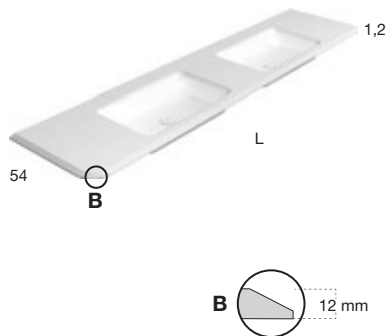

H P L
 1,2 54 da / from 162 a / to 216

Top con lavabo integrato ovale in vetro a filo piatto o con smusso, completo di piletta con scarico libero e raccordo per sifone.
Glass top with integrated oval sink with polished or bevelled edge complete with drain pipe fitting and open plug.

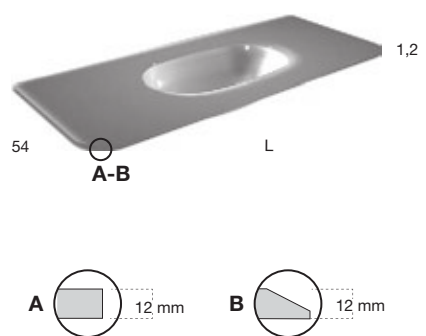

H P L
 1,2 54 da / from 90 a / to 216

TOP ▲

antoniolupi produce sartorialmente tutto quello che ha a che fare con la sala da bagno: mobili (attualmente divisi in dieci collezioni), sanitari, vasche, rubinetteria, specchi e illuminazione, piatti e box doccia, soffioni, radiatori, accessori e complementi d'arredo. Partendo dall'idea che la sala da bagno sia il centro della casa, già da tempo ha introdotto il camino come complemento, sia con alimentazione a bioetanolo che a legna, creando una divisione camini con una ricca collezione. Camini che possono essere visti e provati in un apposito showroom aziendale e che ovviamente non hanno soltanto il bagno come destinazione.

antoniolupi tailor makes everything for the bathroom: furniture (currently divided up in 10 collections), sanitary-ware, bathtubs, taps, mirrors and lighting, shower trays and enclosures, overhead showers, radiators, accessories and furnishings. If we consider that the bathroom is the heart of the home, the fireplace was introduced as a complement long ago either with bio-ethanol or wood burning, creating a great collection. Fireplaces that can be seen and tried in a special showroom and that not only have the bathroom as their destination.

research and innovation

Sperimentare, ricercare, esplorare, essere curiosi, non fermarsi ai risultati ottenuti ma andare oltre, sempre, in molteplici direzioni, raccogliendo sollecitazioni e influenze diverse, proveniente anche da mondi lontani. Ricerca e innovazione sono da sempre nel dna di antoniolupi, lo sono sin dall'origine dell'azienda e ne hanno orientato il percorso evolutivo in questi anni. L'esplorazione del nuovo e l'attenzione per ogni forma di creatività è nel carattere delle persone che la guidano, è un'attitudine che si alimenta giorno per giorno, è un approccio che viene trasmesso a tutti coloro che ne fanno parte. Per questo antoniolupi è da sempre in prima fila nell'innovazione di processo, nella ricerca estetica e funzionale sul prodotto, nell'esplorazione di nuovi materiali o nell'utilizzo inedito dei più tradizionali, nell'impiego di tecnologie evolute per riattualizzare il valore di materie antiche. L'incontro tra materia e uomo avviene così, all'insegna della continua sperimentazione, forti della conoscenza sulle tecniche di lavorazione e della capacità di integrare competenze nuove e specifiche. Un percorso che ha portato a esplorare al meglio le potenzialità di tutti gli strumenti preziosi che la natura mette a disposizione del progetto ma che è andato oltre, per sviluppare nuovi materiali di sintesi capaci di garantire prestazioni eccellenti e di soddisfare le esigenze estetiche e di stile. Materiali che sono entrati rapidamente nel vissuto dell'azienda e che oggi permettono di esprimere al meglio uno spirito contemporaneo e un linguaggio elegante e sofisticato.

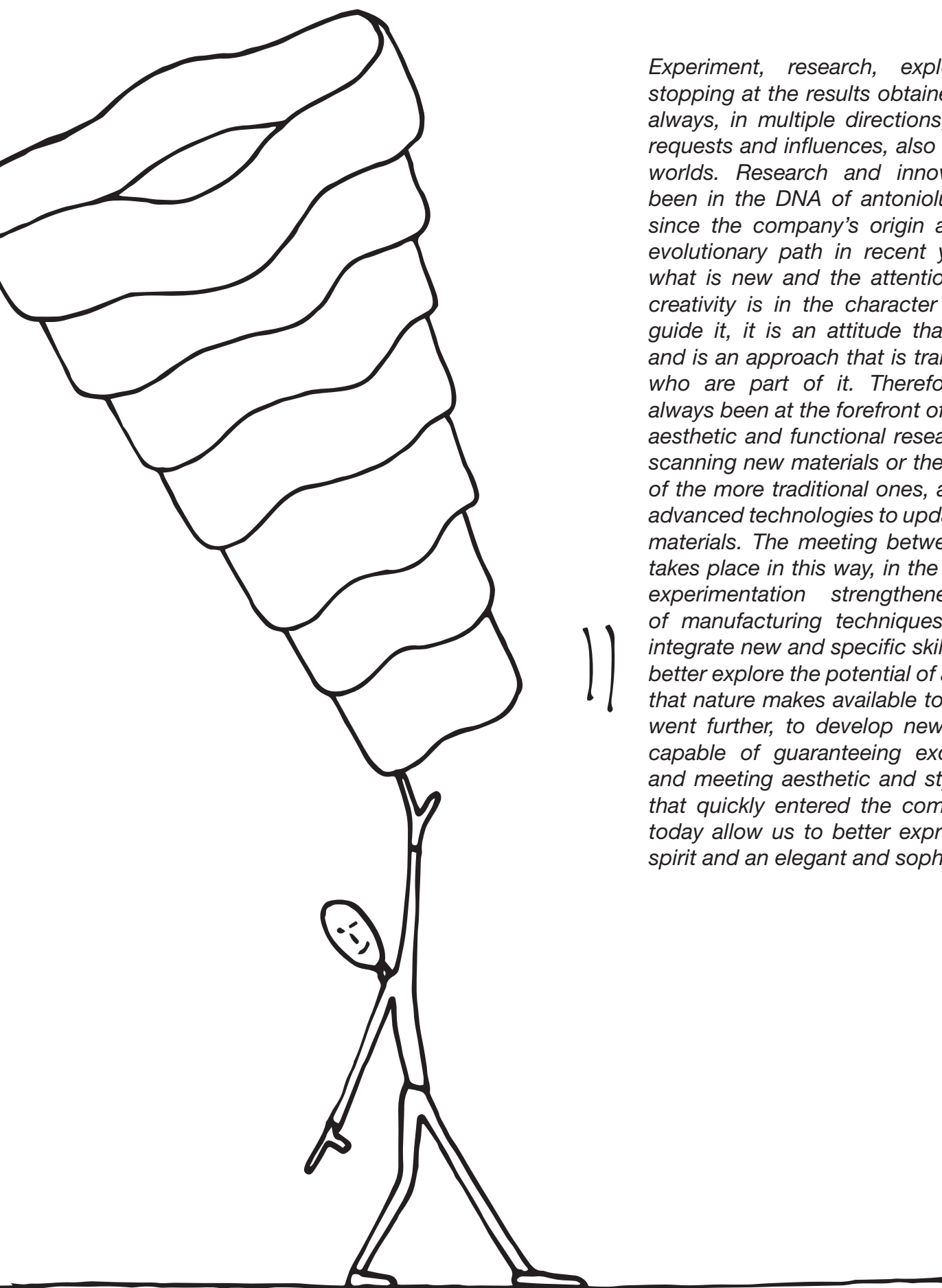

Experiment, research, explore, curiosity, not stopping at the results obtained but going further, always, in multiple directions, gathering different requests and influences, also coming from distant worlds. Research and innovation have always been in the DNA of antoniolupi, they have been since the company's origin and have guided its evolutionary path in recent years. The study of what is new and the attention for every form of creativity is in the character of the people who guide it, it is an attitude that feeds day by day and is an approach that is transmitted to all those who are part of it. Therefore, antoniolupi has always been at the forefront of process innovation, aesthetic and functional research on the product, scanning new materials or the unprecedented use of the more traditional ones, as well as the use of advanced technologies to update the value of older materials. The meeting between man and matter takes place in this way, in the name of continuous experimentation strengthened by knowledge of manufacturing techniques and the ability to integrate new and specific skills. A path that led to better explore the potential of all the precious tools that nature makes available to the project but that went further, to develop new synthetic materials capable of guaranteeing excellent performance and meeting aesthetic and style needs. Materials that quickly entered the company's life and that today allow us to better express a contemporary spirit and an elegant and sophisticated language.

CARTELLA COLORI - LEGNI LACCATI - VETRI - COLOR CHART - LACQUERED WOODS - GLASSES

Disponibili in laccati opachi, goffrati, seta o lucidi. I vetri possono essere acidati o lucidi con spessore 4 mm, 8 mm, 12 mm

Available in matt, embossed, silk or glossy lacquered. Glass tops can be acid-etched or polished with 4 mm, 8 mm, 12 mm thickness



Coccodrillo



Kajal



Vino



Mirto



Pompeiano



Veneziano



Bambola



Anatra



Vespa



Lambretta



Alga



Era glaciale



Rana blu



Catalina



Profondo blu



Bianco mood

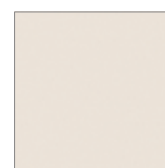

Biancospino

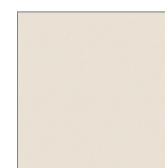

Ovatta



Meringa



Bianco

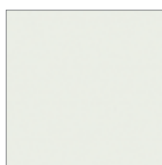

Bianco vetro

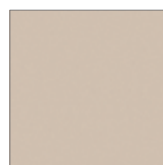

Tortora



Havana



Malta



Grigio vesuvio



Corteccia

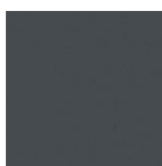

Matita



Strada



Grigio piombo



Grigio pioggia



Creta



Grigio smog



Cemento



Pomice



Blu navy



Mirtillo



Ossido



Cielo

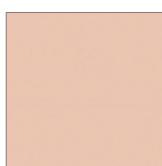

Cipria



Terracotta



Geranio



Melograno



Malva



Mostarda



Flora

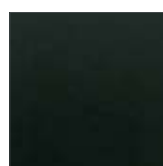

Skin cenere



Nero

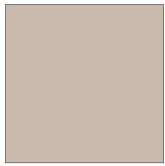

Falena



Serena



Iceberg



Basalto



Ramerino

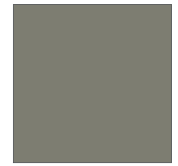

Lichene

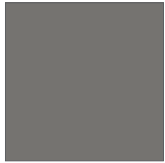

Delfino

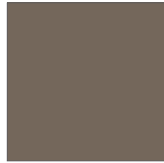

Mamba



Smoke



Argilla

ESSENZE LEGNO - WOOD ESSENCE



Noce canaletto



Noce visone

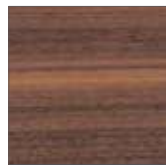

Noce canadese



Rovere thermo



Rovere evaporato

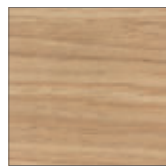

Rovere naturale



Rovere sbiancato



Rovere matita



Rovere grigio



Rovere ardesia



Rovere castano



Rovere moro

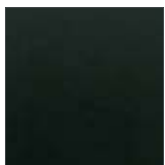

Skin cenere

FLUMOOD



Bianco



Falena



Serena

COLORMOOD

**N.B: PER OTTENERE UN IDENTICO COLORE RISPETTO AL TOP IN COLORMOOD DEVE ESSERE UTILIZZATA LA FINITURA SETA -
P.S: IN ORDER TO OBTAIN THE SAME IDENTICAL COLOR AS THE TOP IN COLORMOOD YOU MUST ORDER THE SILK FINISH.**

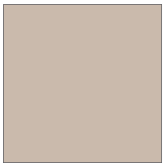

Falena

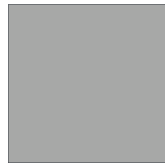

Serena



Iceberg



Basalto



Ramerino

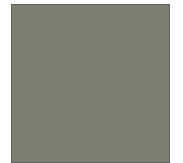

Lichene

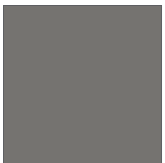

Delfino

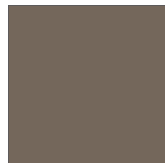

Mamba

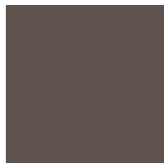

Smoke



Argilla

CORIAN



Bianco

CRISTALPLANT



Bianco

PIETRE - STONES



Stone Grey



Luna

CORNICI - FRAMES

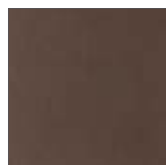

Bronzo



Zirconio

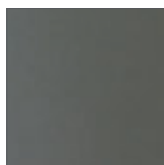

Titanio

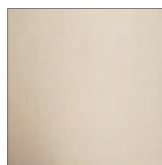

Champagne

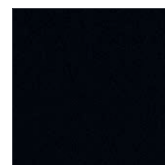

Nero opaco
Matt black

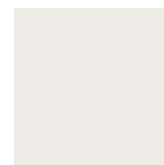

Bianco opaco
Matt white

“BEMADE” Cornice verniciata gofrata come da nostro campionario colori.

“BEMADE” Frame lacquered in an embossed finish as per our sample colors.



VETRI - GLASS



Argentato naturale
Natural mirrored



Argentato bronzo
Bronze mirrored



Argentato fumè
Fumè mirrored



Riflettente fumè
Fumè mirrored



Trasparente bronzo
Transparent bronze



Trasparente fumè
Transparent fumè

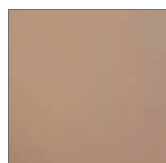

Acidato bronzo
Bronze acid

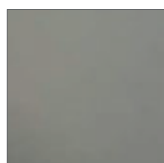

Acidato fumè
Fumè acid



Cannettato trasparente
Ribbed clear

Vetro acidato e cannettato laccato come da nostro campionario colori.

Acid etched and ribbed glass lacquered as per our color samples.



Vetro acidato laccato
Acid lacquered glass

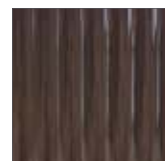

Cannettato laccato
Ribbed lacquered

MARMI - MARBLES

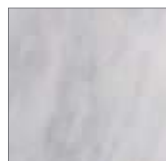

Bianco Carrara



Nero Marquina



Petra Ruja



Calacatta oro



Verde Guatemala



Emperador

METALLO LIQUIDO - LIQUID METAL

La verniciatura Metallo liquido non ha nessun protettivo, quindi si ossida nel tempo conferendo ad ogni prodotto un colore ed una texture propria e differente, mutevole nel tempo.

Liquid metal painting has no protective properties, therefore it oxidizes over time, giving each product its own different color and texture, which changes over time.



Rame
Copper

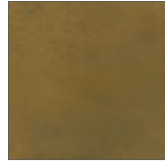

Ottone
Brass

POLVERE DI METALLO - METAL POWDER



Bronzo
Bronze powder



Ferro
Iron powder



Ottone
Brass powder



Rame
Copper powder



Corten
Corten powder

CRISTALMOOD



Notturmo



Ceruleo



Bottiglia



Oleo



Nebbia



Fumè



Gran Cru



Odra



Barrique



Mostato



Vespero



Ginger

SUGHERO - CORK



Naturale
Natural cork



Tostato
Toasted cork



POLVERE DI METALLO FINITURA FERRO
METAL POWDER IRON FINISH



an

toniolupi



Prodotto interamente in Italia
Entirely made in Italy

©Antonio Lupi Design S.p.A. 2022



Scarica l'App su App Store e Google Play per entrare nel mondo antoniolupi

Download the App on App Store and Google Play to discover the world of antoniolupi

www.antoniolupi.it

Per essere costantemente informati su novità e prodotti in modo dettagliato, vi invitiamo a navigare nel nostro sito sempre aggiornato.

Nell'area download potrete scaricare tutto il materiale tecnico ed informativo che vi necessita.

*To constantly be up to date in a detailed manner on novelties and products please navigate through our website.
In the download area you can find all the necessary technical information.*

NOTA

Alla Antonio Lupi Design S.p.A. è riservata la facoltà di apportare ai propri modelli qualsiasi modifica estetica, tecnica, nelle dimensioni e nei colori, ritenuta necessaria, nonché la facoltà di sospendere la produzione in qualunque momento senza preavviso, rinunziata fin d'ora da parte del committente ogni conseguente richiesta risarcitoria.

Si declina ogni responsabilità relativa ad eventuali inesattezze contenute in questo catalogo, se dovute ad errori di stampa o trascrizioni.

Nessun contenuto di questo catalogo può essere copiato, riprodotto anche parzialmente, ripubblicato, trasmesso o distribuito in qualunque forma, senza autorizzazione scritta dell'Antonio Lupi Design S.p.a.

NOTE

Antonio Lupi Design S.p.A. reserves the right to make any and all necessary aesthetic, technical, colour or size modifications in order to enhance use and aesthetic value, and may suspend the production cycle at any moment without notice. Such instances may not be subject to claim by the client.

We decline all responsibilities for any possible uncertainties due to misprints in this catalogue.

None of the material in this catalogue can be copied, reproduced, republished or distributed in any or partial way unless a written authorization is given from the company Antonio Lupi Design S.p.a.



ATTREZZATURA CASSETTI
DRAWERS EQUIPMENT

BEMADE

BESPOKE

ATELIER

PANTA REI

PIANA

BINARIO

ORMA

ILBAGNO

FINITURE
FINISHES

lo stato
delle idee /
the state of
ideas