

GLOBO

Catalogo Generale /
General Catalogue /
Gesamtkatalog

16.1

Inspired by Life

Impegnata da sempre a interpretare i gusti e le nuove tendenze, Ceramica Globo guarda al futuro con continue innovazioni di processo e di prodotto che richiedono l'integrazione delle più diverse competenze, dal design all'ingegneria, dalla chimica dei materiali alla logistica, dal marketing alla sociologia. Sempre attenti al risparmio energetico e alla salvaguardia dell'ambiente.

Always committed to interpreting new tastes and trends, Ceramica Globo looks to the future with continuous innovation of its processes and products. This requires the integration of different skills, from the design to engineering, from chemistry to logistics, from marketing to sociology. The company has always paid great attention to saving energy and protecting the environment.

Seit jeher bemüht, die Geschmäcker und die neuen Trends zu interpretieren, blickt das Unternehmen mit kontinuierlichen Verfahrens- und Produktinnovationen, die die Integration der unterschiedlichsten Kompetenzen -vom Design zur Ingenieurwissenschaft, von der Chemie zur Logistik, vom Marketing zur Soziologie- erfordern, in die Zukunft. Dabei ist das Unternehmen stets auf die Energieeinsparung und den Umweltschutz bedacht.

GLOBO

L'azienda Ceramica Globo

The Company: Ceramica Globo / Das Unternehmen: Ceramica Globo



Prodotti e collezioni che si sposano perfettamente con ogni ambiente bagno decretano ogni giorno il grande successo di Ceramica Globo, una realtà che da oltre 30 anni stupisce il mercato, impreziosendo con stile ed eleganza momenti di benessere ed intimità.

Products and collection that go perfectly with any bathroom setting contribute to the great success of Ceramica Globo, a company that has been amazing the market for over 30 years, adding a touch of style and elegance to moments of wellness and intimacy.

Produkte und Kollektionen, die sich perfekt an jede Badumgebung anpassen, beschließen Tag für Tag den großen Erfolg von Ceramica Globo, eine Realität, die seit mehr als 30 Jahren den Markt überrascht und mit Stil und Eleganz Momente der Wellness und Intimität schafft.

Mentalità vincente, capitale umano di altissimo livello, innovazione tecnologica, capacità di essere sempre attuale e massima attenzione per l'ambiente, da sempre consentono a Ceramica Globo di posizionarsi tra le aziende più apprezzate del comparto igienicosanitario e dell'arredobagno.

Winning mentality, highly skilled and experienced staff, technological innovation, continuous updating, and maximum attention to the environment are the values that have allowed Ceramica Globo to become one of the most important companies in the field of sanitaryware and bathroom furnishings.

Gewinnende Mentalität, Humankapital von höchstem Niveau, technologische Innovation, die Fähigkeit, immer auf dem neuesten Stand zu sein und größte Aufmerksamkeit gegenüber der Umwelt erlauben Ceramica Globo, sich unter den am meisten geschätzten Unternehmen der Sanitär- und Badeinrichtungsbranche einzureihen.



3

stabilimenti produttivi
manufacturing plants
Produktionsstätten



150mila

m² di superficie
surface area (sqm)
150.000 m² Fläche



50

più di 50 nazioni servite
more than 50 countries served
mehr als 50 bediente Länder



1500

articoli a catalogo
products in the catalogue
Artikel im Katalog

La sua vasta gamma abbraccia trasversalmente ogni gusto ed esigenza, assicurando alta qualità ed un elevato design, in sinergia con la massima funzionalità possibile che garantisce elevato comfort nell'utilizzo. Il continuo sviluppo dell'azienda, la sua affermazione sul territorio italiano e la sua espansione oltre i confini nazionali attestano il successo del brand, un baluardo dello stile e della classe "Made in Italy" e vanto del distretto industriale che rappresenta l'eccellenza nello specifico settore.

Its wide range of products covers all tastes and needs, ensuring high quality and design, in synergy with extreme functionality for maximum comfort and use. The company's continuous development, its consolidation in Italy and expansion beyond the national borders are testimony of the brand's success, a bastion of "Made in Italy" style and class based in the industrial district that represents the excellence in the specific sector.

Die breite Produktpalette des Unternehmens umfasst übergreifend jeden Geschmack und Anspruch und gewährleistet gleichzeitig hohe Qualität und gehobenes Design in Synergie mit der höchstmöglichen Funktionalität, die einen hohen Komfort bei der Verwendung garantiert. Die kontinuierliche Entwicklung des Unternehmens, seine Bewährung in Italien und seine Expansion über die nationalen Grenzen hinaus zeugen vom Erfolg der Marke, ein Bollwerk des Stils und der Klasse "Made in Italy" und Stolz des Industriedistrikts, der die Exzellenz in dieser speziellen Branche vertritt.

La tecnologia, le persone e i valori

Technology, people and values / Die Technologie, die Menschen und die Werte

Protagonista di una significativa ristrutturazione che sottolinea la fiducia nel proprio futuro, la sede di Ceramica Globo ha un nuovo volto che si basa su un design rigoroso, razionalità, tecnologia, know-how specifico e cultura della sostenibilità, proprio come i valori della sua filosofia aziendale.

Protagonist of a important restructuring process that reflects the confidence in its future, Ceramica Globo's headquarters has a new face that is based on rigorous design, rationality, technology, specific know-how and culture of sustainability, in line with the values of its corporate philosophy.

Das Unternehmen ist Protagonist einer bedeutenden Umstrukturierung, die das Vertrauen in die eigene Zukunft betont. Der Geschäftssitz von Ceramica Globo hat ein neues Gesicht, das auf einem strengen Design, Rationalität, Technologie, speziellem Know-how und der Kultur der Nachhaltigkeit, genau wie die Werte der Unternehmensphilosophie, basiert.

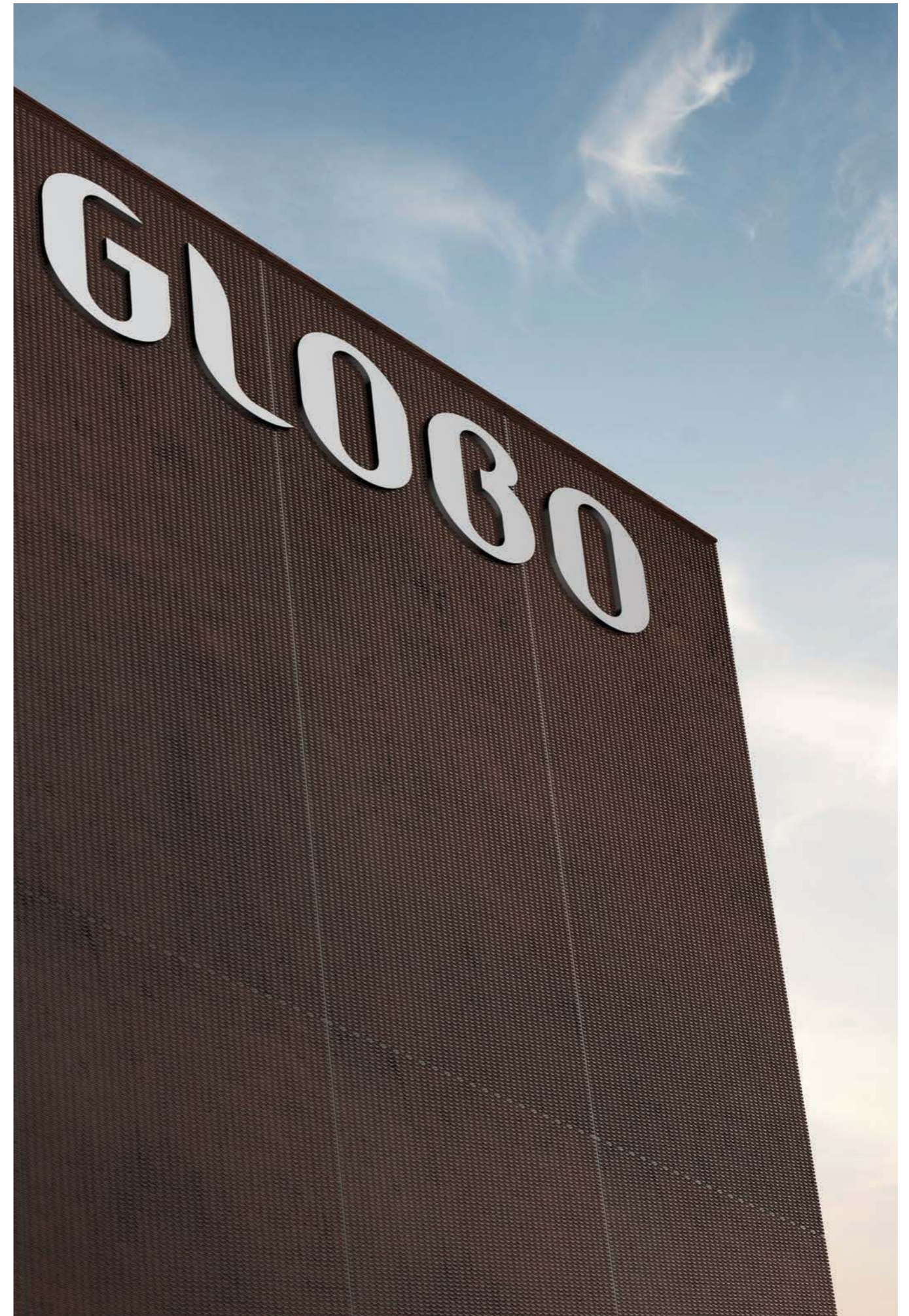

Sala mostra aziendale /
Company showroom /
Showroom des Unternehmens

Fiore all'occhiello del nuovo restyling è la sala mostra, un luogo preposto a condurre il visitatore in un vero e proprio percorso esperienziale volto a conoscere in profondità gli aspetti innovativi di ogni collezione di Ceramica Globo.

The showroom is the pride and joy of the new restyling. It takes visitors on a journey where they can learn all about the innovative aspects of each Ceramica Globo collection.

Flaggschiff des neuen Umgestaltung ist der Showroom, ein Ort, in dem der Besucher durch einen wahren experimentellen Pfad geführt wird. Dieser zielt darauf ab, die innovativen Aspekte jeder Kollektion von Ceramica Globo eingehend zu präsentieren.



Evento durante il Salone del Mobile nel cortile / An event during the Salone del Mobile (Furniture Fair) / Event während des „Salone del Mobile“ im Hof

Showroom Globo, Milan, Corso Monforte 15

Il meeting Center, inoltre, si inserisce nei luoghi dell'azienda in cui si concretizzano preziosi momenti di incontro, formazione e informazione: essenziali per confrontarsi, essere aggiornati ed affrontare ogni dinamica di mercato con la giusta preparazione e consapevolezza.

The Meeting Center also fits perfectly into the company's spaces, offering precious moments of dialogue, training and education: essential to exchange ideas, to stay up to date and to face any market challenge with the right preparation and awareness.

Das Meeting Center fügt sich zwischen die Plätze des Unternehmens ein. Hier konkretisieren sich wertvolle Momente der Begegnung, Schulung und Information: sie sind grundlegend, um sich auseinanderzusetzen, um auf dem Laufenden gehalten zu werden und um jeder Dynamik des Marktes mit der richtigen Vorbereitung und Wissen zu begegnen.



Centro congressi / Congress Center / Kongresszentrum



Lo Showroom di Milano, situato in una delle aree più rilevanti del design Italiano, è destinato all'esposizione del mondo Globo e dei suoi valori: un'importante vetrina segno tangibile di quanto sia irrinunciabile la cura dei rapporti umani tra l'Azienda e gli attori del suo mercato. Ad assistere il segmento del contract e tutto il pubblico che si avvicina alle diverse collezioni, sono presenti architetti esperti in grado di rispondere a ogni specifica esigenza.

Der Showroom in Mailand, in einer der bedeutendsten Gegenden des italienischen Designs gelegen, ist für die Ausstellung der Welt von Globo und der Unternehmenswerte bestimmt: ein bedeutendes Schaufenster als greifbares Zeichen für die Unverzichtbarkeit auf die Pflege der menschlichen Beziehungen zwischen dem Unternehmen und den Akteuren des Marktes. Um dem Contract-Segment und dem gesamten Publikum, das sich den verschiedenen Kollektionen annähert, beizustehen, sind erfahrene Architekten präsent, die in der Lage sind, auf jeden speziellen Anspruch zu reagieren.

The Milan Showroom, located in one of the most important areas of Italian design, is dedicated to exhibiting the Globo world and its values; an important showcase and tangible sign of how crucial it is to build meaningful relationships and partnerships between the Company and professionals in the market. Architects and experts are available in the showroom to assist and respond to requests of visitors.



Esposizione all'ingresso dell'azienda / Exhibition area at the entrance of the company / Ausstellung im Eingangsbereich des Unternehmens



Globo Concept Shop, Hong Kong



Ogni nuovo progetto, sia per una linea inedita che per il restyling di una collezione già esistente, è frutto di precise e minuziose operazioni di analisi, un sapiente mix tra studio del mercato, rispetto delle specifiche normative e funzionalità del prodotto.

Every new project, whether a new line or the restyling of an existing collection, is the result of a precise and meticulous analysis, a clever mix between market research, regulatory compliance and product functionality.

Jedes neue Projekt, sowohl für eine unveröffentlichte Linie als auch für das Restyling einer bereits bestehenden Kollektion, ist Ergebnis von präzisen und detaillierten Analysemaßnahmen, eine wohlüberlegte Mischung aus Marktstudien, Einhaltung bestimmter Vorschriften und Funktionalität des Produkts.

PRODUCT & DESIGN

La risposta giusta ad ogni esigenza

The right solution for every need / Die richtige Antwort für jede Anforderung

Da sempre Ceramica Globo pone la massima attenzione alla qualità e funzionalità dei suoi prodotti. Si tratta di due capisaldi delle scelte progettuali rimasti invariati nonostante il cambiamento dei trend di mercato che richiedono nel tempo diverse forme e design. L'Azienda, oggi impegnata in un'importante processo d'internazionalizzazione, mantiene la massima coerenza con una precisa filosofia di prodotto riconoscibile in ogni singola collezione. In una parola, con la sua identità.

Ceramica Globo has always paid the utmost attention to the quality and functionality of its products. These two pillars of the design choice have always remained the same despite changes in market trends that over time request different shapes and designs. The company is currently engaged in an important internationalisation process, while maintaining maximum consistency with the product philosophy recognisable in every single collection. In a word, its identity.

Seit jeher legt Ceramica Globo höchsten Wert auf die Qualität und Funktionalität seiner Produkte. Es handelt sich um zwei Fixpunkte der Designentscheidungen, die trotz der Veränderungen der Markttrends, die im Laufe der Zeit verschiedene Formen und unterschiedliches Design erfordern, unverändert geblieben sind. Das Unternehmen, das heute in einem bedeutenden Internationalisierungsprozess eingebunden ist, hält seine maximale Schlüssigkeit mit einer präzisen Produktphilosophie, die in jeder einzelnen Kollektion wiedererkennbar ist, bei. In einem Wort, mit seiner Identität.

Caratteristiche del prodotto

● QUALITÀ QUALITY QUALITÄT
 ● GAMMA RANGE PRODUKTPALETTE
 ● AFFIDABILITÀ RELIABILITY ZUVERLÄSSIGKEIT
 ● DESIGN DESIGN DESIGN

Product features / Merkmale des Produkts



QUALITY

Alla base di ogni prodotto c'è la scelta di offrire una tecnica perfetta che garantisce alte performance e lunga durata nel tempo.

Each product is based on the idea of offering a perfect technique that ensures high performances and long life.

An der Basis jedes Produkts steht die Entscheidung, eine perfekte Technik, die hohe Performance und Langlebigkeit garantiert, anzubieten.

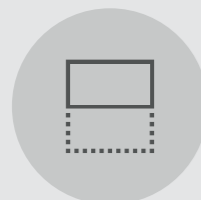

RANGE

Grande modularità delle soluzioni e una vasta gamma che comprende molteplici forme, dimensioni, colori e finiture per rispondere a qualsiasi esigenza del cliente.

Excellent modularity and a wide range that includes many shapes, sizes, colours and finishes to meet any customer need.

Die große Modularität der Lösungen und ein breites Angebot, das vielfältige Formen, Abmessungen, Farben und Finishes umfasst, antworten auf jeglichen Anspruch des Kunden.

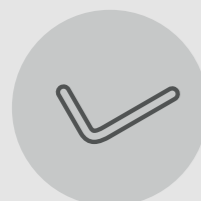

RELIABILITY

La rigorosa progettazione, l'eccellente fase di produzione ed il controllo di ogni prodotto, partendo dalle materie prime, garantiscono un prodotto affidabile al 100%.

Maximum reliability is ensured by the rigorous design, excellent production phase and control of each product, starting from the raw materials.

Die strenge Planung, die herausragende Produktionsphase und die Kontrolle jedes einzelnen Produktes, ausgehend vom Rohstoff, gewährleisten ein zu 100% zuverlässiges Produkt.



DESIGN

La capacità di offrire una soluzione ad ogni specifica esigenza passa attraverso lo studio e la realizzazione di un design funzionale che ingloba comfort e gusto estetico.

The ability to offer a solution to every problem passes through the study and development of a functional design that incorporates comfort and aesthetic taste.

Die Fähigkeit, eine Lösung für jeden speziellen Anspruch zu bieten, durchläuft die Erarbeitung und die Umsetzung eines funktionalen Designs, das Komfort und ästhetischen Geschmack umfasst.



Superfici planari
Smooth surfaces
Ebene Oberflächen



Smalto perfetto
Perfect glaze
Perfekte Glasur



Spigoli perfetti
Perfect edges
Perfekte Kanten



Tecnologia e igiene
Technology and hygiene
Technologie und Hygiene



14 colori ceramici
14 ceramic colours
14 Keramikfarben



Grande numero prodotti
Large number of products
Große Anzahl an Produkten



Tanti prodotti per diversi tipi di installazione
Numerous products for different types of installation
Zahlreiche Produkte für verschiedene Installationsmethoden



Diverse fasce di prezzo
Different price ranges
Verschiedene Preisklassen



Resistenza meccanica
Mechanical resistance
Mechanische Festigkeit



Test di tenuta acqua
Watertightness test
Wasserdichtheitsprüfung



Certificazioni
Certifications
Zertifizierungen



Standard internazionali
International standards
Internationale Standards



Design per tutti
A design for everyone
Design für Alle



Soluzioni salvaspazio
Space-saving solutions
Raumsparende Lösungen



Ristrutturazioni semplificate
Simplified restructuring
Vereinfachte Sanierungen



Estetica per tutti i gusti
Aesthetic styles for all tastes
Ästhetik für jeden Geschmack

Team creativo per nuove idee

Creative team for new ideas / Kreativteam für neue Ideen

Giulio Iacchetti



Luca Nichetto

Thukral & Tagra



Claesson Koivisto Rune



GamFratesi

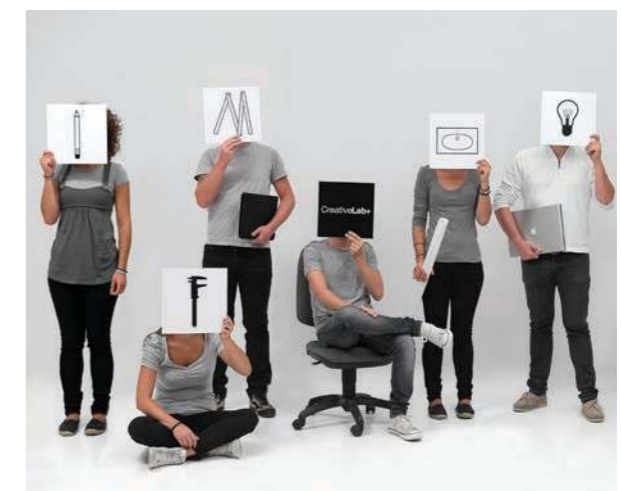

CreativeLab+

Ceramica Globo impone proprio questo costante slancio che sfocia nella produzione di soluzioni capaci di precorrere i tempi, stupendo per la loro attualità. Tutto ciò, rispettando rigorosamente i processi che hanno permesso di ottenere numerose certificazioni di qualità.

Ceramica Globo uses this continuous momentum to develop solutions that anticipate the times, and offer amazing innovation. All this, plus strict compliance with the processes, have allowed the company to obtain numerous quality certifications.

Ceramica Globo imponiert durch genau diesen konstanten Elan, der in der Herstellung von Lösungen, die in der Lage sind, die Zeit zu überdauern und dabei durch ihre Aktualität zu überraschen, mündet. Dies alles erfolgt unter strenger Einhaltung der Verfahren, die es ermöglicht haben, zahlreiche Qualitätszertifizierungen zu erhalten.

Tradurre "il bello" in un prodotto all'avanguardia è il punto di incontro tra design, innovazione e tecnologia, il presente che guarda al futuro con orgoglio e soddisfazione.

Translating "beauty" in a cutting-edge product is the meeting point between design, innovation and technology. The present that looks to the future with pride and satisfaction.

"Das Schöne" in ein fortschrittliches Produkt zu übersetzen, ist der Treffpunkt zwischen Design, Innovation und Technologie, die Gegenwart, die mit Stolz und Zufriedenheit in die Zukunft blickt.

Referenza \ Reference \
 Referenz: A.S.I. (Agenzia
 spaziale Italiana), Rome

Rivolti sempre al prossimo traguardo

Always focused on the next goal / Immer auf das nächste Ziel ausgerichtet

Centrato un obiettivo, il team di ricerca e sviluppo di Ceramica Globo inizia un nuovo viaggio che porta con sé costante innovazione per vivere nel presente l'ambiente bagno del futuro.

Hitting a target, the research and development team of Ceramica Globo embark on a new journey of innovation to bring the bathroom of the future to the present.

Nach Zentrieren eines Ziels beginnt für das Forschungs- und Entwicklungsteam eine neue Reise, die eine konstante Innovation mit sich bringt, um im präsenten Badambiente der Zukunft zu leben.

I continui progressi tecnologici sono comprovati dai numerosi brevetti che portano con sé prestazioni eccezionali, performance e caratteristiche legate al brand, capace di seguire i trend di oggi che dettano bordi sempre più sottili e minori consumi di acqua.

The company's continuous technological advancements are proven by numerous patents that deliver outstanding performances and characteristics, allowing the brand to follow today's trends for thinner borders and less water consumption.

Die kontinuierlichen technologischen Fortschritte wurden durch zahlreiche Patente, die herausragende Leistungen, Performance und Merkmale, die an die Marke gebunden sind, mit sich bringen, bestätigt. Diese sind in der Lage, den heutigen Trends, die stets dünnere Ränder und geringeren Wasserverbrauch diktieren, zu folgen.

Superfici perfette e massima igiene

Perfect surfaces and maximum hygiene / Perfekte Oberfläche und maximale Hygiene



Frutto della costante attività di ricerca e sviluppo di Ceramica Globo, CERASLIDE® è l'innovativo smalto studiato e testato per ottenere un'efficacia inalterabile nel tempo.

From Ceramica Globo's research and development comes CERASLIDE®, the innovative glaze designed and tested to maintain its effectiveness over time.

Das Ergebnis der Forschungs- und Entwicklungstätigkeit von Ceramica Globo ist CERASLIDE®, die innovative und getestete Glasur, um eine unveränderliche Wirksamkeit im Laufe der Zeit zu erhalten.

L'attento controllo delle temperature nelle varie fasi di cottura, in un ciclo che arriva a 26 ore, garantisce al processo di sinterizzazione una perfetta omogeneità del prodotto, diminuendo la porosità e assicurando una maggiore resistenza alle macchie, allo sporco e all'abrasione : in questo modo i residui non aderiscono alle pareti scivolando via insieme all'acqua ; per garantire una sempre maggiore attenzione all'igiene è stato sviluppato il trattamento antibatterico BATAFORM® , un processo insito alla fase di produzione che grazie al suo potere antimicrobico riduce

The careful control of temperatures in the various cooking stages, in a cycle that can last up to 26 hours, ensures perfect homogeneity of the product during the sintering process, reducing porosity and guaranteeing greater resistance against stains, dirt and abrasions. This means the residuals do not adhere to the walls but slide off with the water. The BATAFORM® antibacterial treatment was developed to ensure deeper hygiene. The antimicrobial power of this process during production significantly reduces the presence of germs and bacteria.

Die aufmerksame Überprüfung der Temperatur in den verschiedenen Brennphasen während eines Zyklus, der 26 Stunden erreicht, garantiert dem Verfahren des Sinterns eine perfekte Homogenität des Produkts unter Verringerung der Porosität und Gewährleistung einer größeren Beständigkeit gegen Flecken, Schmutz und Abrieb: auf diese Weise haften die Reste nicht an den Wänden und gleiten zusammen mit dem Wasser ab; um der Hygiene eine stets größerer Aufmerksamkeit zu gewährleisten, wurde eine antibakterielle Behandlung entwickelt, BATAFORM®. Dies ist ein Verfahren, das in der

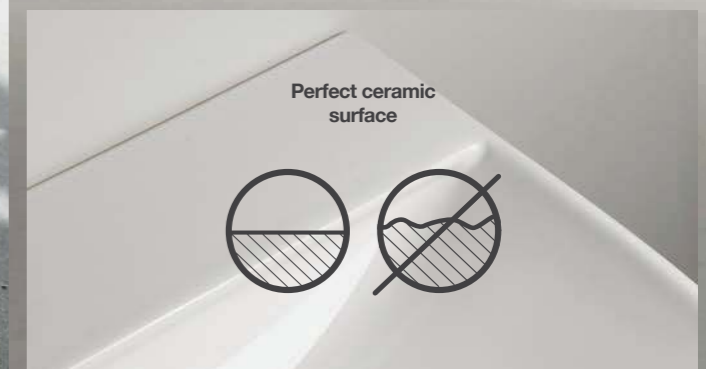
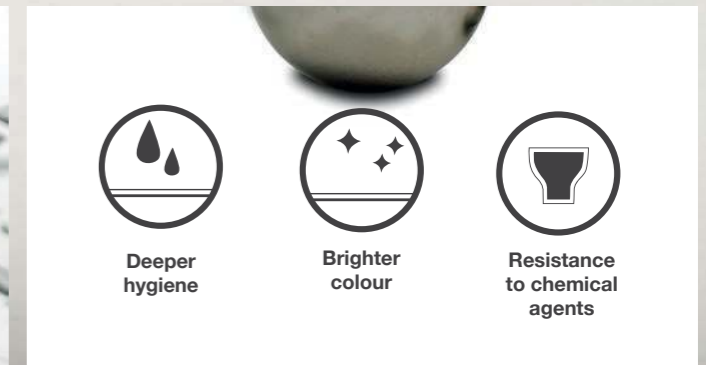

notevolmente la presenza di germi e batteri. I test di laboratorio effettuati secondo gli standard internazionali conformi alla normativa ISO 22196:2011 confermano un drastico calo della presenza di microbi . Lo smalto Ceraslide® in sinergia con il trattamento antibatterico Bataform® dona ai sanitari una maggiore brillantezza, resistenza ed igiene con un particolare occhio di riguardo alla salute di chi vive l'ambiente bagno.

Laboratory tests performed according to the international ISO 22196:2011 standards confirm a drastic decline in the presence of microbes. The Ceraslide® glaze in combination with the Bataform® antibacterial treatment gives sanitary fixtures greater gloss, resistance and hygiene for maximum comfort and wellbeing in the bathroom.

Produktionsphase enthalten ist und dank seiner antimikrobiellen Kraft das Vorhandensein von Keimen und Bakterien bemerkenswert reduziert. Die Labortests, die nach internationalen Standards gemäß der Richtlinie ISO 22196:2011 durchgeführt wurden, bestätigen einen drastischen Rückgang des Vorhandenseins von Mikroben. Die Glasur Ceraslide® in Synergie mit der antibakteriellen Behandlung Bataform® verleiht den Sanitärkeramiken einen stärkeren Glanz, Beständigkeit und Hygiene mit besonderem Augenmerk auf die Gesundheit desjenigen, der das Badambiente lebt.

Il colore nel bagno

Colour in the bathroom / Die Farbe im Bad

Solo con l'alta personalizzazione, un ambiente è capace di rappresentare il proprio gusto estetico in ogni dettaglio di forma e colore. Prerogativa di Ceramica Globo è proprio garantire una perfetta fruizione del bagno, giocando con la creatività, con il fascino dei colori ceramici, con le peculiarità dei materiali e con la scelta delle finiture.

Only with high-level customisation can an environment convey its aesthetic taste in each shape and colour. Ceramica Globo's prerogative is to ensure perfect use of the bathroom, playing with creativity, with the allure of ceramic colours, with the special properties of the materials and choice of the finishes.

Nur durch hohe Personalisierung ist ein Ambiente in der Lage, den eigenen ästhetischen Geschmack in jedem Detail der Form und Farbe zu repräsentieren. Die besondere Eigenschaft von Ceramica Globo ist, eine perfekte Nutzung des Bades zu gewährleisten und dabei mit der Kreativität, mit der Faszination der Keramikfarben, mit den Besonderheiten der Materialien und der Auswahl der Finishes zu spielen.



La versione "Bagno di colore" composta dai 14 colori ceramici è disponibile su tanti articoli di diverse collezioni.

The "Bagno di Colore" version consisting of 14 ceramic colours is available on many items from the different collections.

Die Version "Farbbad", bestehend aus 14 Keramikfarben, ist für zahlreiche Artikel verschiedener Kollektionen erhältlich.

Tutti gli articoli colorati (Bagno di Colore) non hanno lo smalto CERASLIDE® ed il trattamento antibatterico BATAFORM®

All the items in color finishing (Bagno di Colore) do not have the CERASLIDE® glaze nor the BATAFORM® antibacterial treatment

Alle farbigen Artikel (Bagno di Colore) verfügen weder über die CERASLIDE® Glasur noch über die antibakterielle Behandlung BATAFORM®

Negli anni, il bagno ha conquistato un ruolo importante nello spazio domestico: da locale di servizio a stanza nobile della casa. E proprio come per gli altri ambienti, l'arredamento e la scelta del colore assume un ruolo chiave nel conferire personalità e identità. Ceramica Globo ha così sviluppato nuovi colori ceramici, affascinanti alternative al classico bianco, capaci di stupire, incuriosire e ispirare architetti e interior designer.

Over the years the bathroom has acquired an increasingly important role in the home: going from a simple "necessary" space to a prestigious room in the house. Just like other rooms, the decor and colour choice play a key role in giving personality and identity to the bathroom. Ceramica Globo has thus developed new ceramic colours, fascinating alternatives to the classic white, which can amaze, intrigue and inspire architects and interior designers.

Im Laufe der Jahre hat das Bad eine bedeutende Rolle in der häuslichen Umgebung eingenommen: von einem Dienstraum zu einem vornehmen Raum des Hauses. Und genau wie für die anderen Räumlichkeiten übernimmt die Einrichtung und die Wahl der Farbe eine Schlüsselrolle beim Verleihen von Persönlichkeit und Identität. Ceramica Globo hat daher neue Keramikfarben entwickelt, faszinierende Alternativen zum klassischen Weiß, fähig zu überraschen, neugierig zu machen und Architekten und Innendesigner zu inspirieren.

Le tonalità dei colori sono da ritenersi indicative in quanto possono variare in relazione alle modalità di stampa del catalogo.

The colour tones are indicative, as they may change in relation to the printing method of the catalogue.

Die Farbtöne können aufgrund des Druckvorgangs des Katalogs variieren und deswegen sind als lediglich beispielhaft zu betrachten.



Tecnologie e prodotto

Product technology / Technologie und Produkt

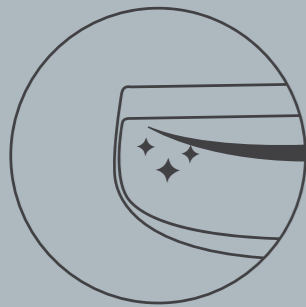
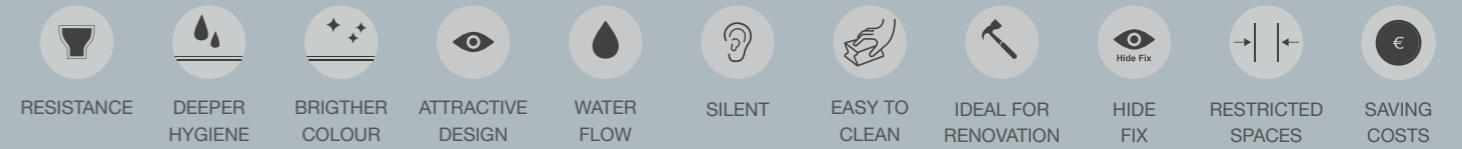

CERASLIDE®
BATAFORM®

Questa nuova formulazione, studiata e testata a fondo per ottenere un'efficacia inalterabile nel tempo, viene applicata sui prodotti garantendo alla ceramica una protezione uniforme.

This new formulation, designed and tested to obtain unalterable efficacy, is applied on ceramic products to ensure uniform protection.

Diese neue Formulierung, die entwickelt und umfassend getestet wurde, um eine unveränderliche Wirksamkeit im Laufe der Zeit zu erhalten, wird auf den Produkten angewendet und garantiert der Keramik einen gleichmäßigen Schutz.

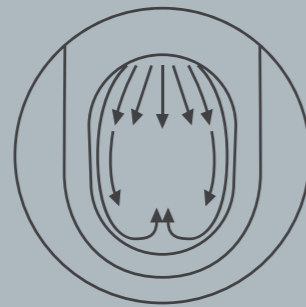

SENZABRIDA®

Lo studio della forma del punto di uscita dell'acqua permette l'eliminazione del bordino vasca per un'estetica molto accurata ed un ottimale flusso d'acqua a servizio della massima igiene.

The special design of the shape of the water exit point allows eliminating the rim of the toilet bowl for an excellent and accurate water flow to achieve maximum hygiene.

Die Erforschung der Form des Punktes des Wasseraustritts ermöglicht die Beseitigung des WC-Randes für eine sehr saubere Ästhetik und einen optimalen Wasserfluss für eine maximale Hygiene.

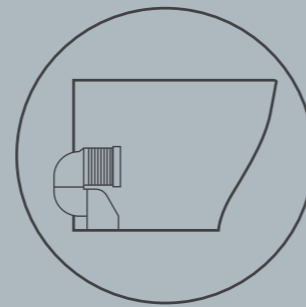

VASOMULTI®
BIDETMULTI®

MULTI è l'innovativo sistema che consente di allacciarsi su scarichi e attacchi idraulici esistenti, per l'installazione di vasi e bidet a terra filo parete.

MULTI is the innovative system that can attach itself to existing drains and water connections, for the installation of back-to-wall toilets and bidets.

MULTI ist das innovative System, das den Anschluss an bestehende Wasserabflüsse und -anschlüsse für die Installation von wandbündigen bodenstehenden WCs und Bidets erlaubt.

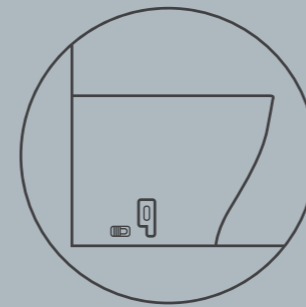

FISSAGGIOGHOST®

Il sistema di fissaggio dei vasi e bidet a terra è completamente nascosto, grazie a un brevetto sviluppato ed ingegnerizzato da Ceramica Globo.

The fixing system of the floor-mounted toilets and bidets is completely hidden, thanks to a patent developed and engineered by Ceramica Globo.

Das neue Befestigungssystem für bodenstehende WCs und Bidets ist dank eines von Ceramica Globo entwickelten und konstruierten Patents vollständig verborgen.

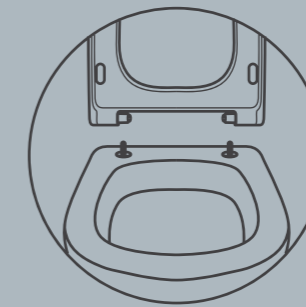

EASY DETACH

Le nuove cerniere a sgancio rapido, permettono di togliere il coprivaso con un gesto semplice e veloce.

The new quick-release hinges allow removing the toilet seat with one simple gesture.

Mit den neuen Scharnieren mit dem Quick-Release-System können Sie den WC-Sitz leicht und blitzschnell abnehmen.

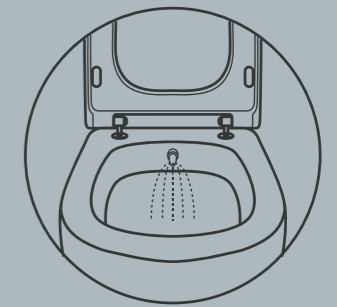

WC - BIDET

I vasi-bidet Globo nascono per unire esigenze differenti, utili in spazi ristretti per la loro duplice funzione, in secondi bagni e ristrutturazioni.

The Globo toilets-bidets were created to combine different needs, suitable for small spaces due to their dual function, in second bathrooms and renovations.

Die WCs-Bidets Globo entstehen, um unterschiedliche Ansprüche zu vereinen. Aufgrund ihrer Doppelfunktion sind sie in engen Räumen, Zweitbädern und bei Sanierungen nützlich.



Qualità italiana

Italian quality / Italienische Qualität



Il valore del Made in Italy si eleva in ogni prodotto, mostrando lo specifico know how che permette di dar vita a soluzioni di grande stile, capaci di rendere l'ambiente bagno un luogo speciale da vivere e ammirare.

The "Made in Italy" value is found in every product, attesting to the specific know-how that allows creating solutions of great style that can turn the bathroom into a special place to be enjoyed and admired.

Der Wert des Made in Italy zeigt sich in jedem Produkt und offenbart das spezielle Know-how, das ermöglicht, stilvollen Lösungen, die in der Lage sind, die Badumgebung zu einem zu erlebenden und bewundernden speziellen Ort zu machen, Leben zu verleihen.

Certificazioni

Certifications / Zertifizierungen



UNI EN ISO 9001: 2008 Certifica che tutte le fasi del processo produttivo sono eseguite seguendo procedure molto rigide e con controlli periodici che consentono di mantenere standard qualitativi costanti nel tempo.

UNI EN ISO 9001:2008 Certifies that all the production stages are carried out by following very strict procedures with periodical checks aimed at maintaining high quality standards over time.

UNI EN ISO 9001: 2008 Zertifiziert, dass alle Phasen des Produktionsprozesses unter Einhaltung sehr strenger Verfahren und mit regelmäßigen Kontrollen, die die Beibehaltung von konstanten Qualitätsstandards im Laufe der Zeit ermöglichen, ausgeführt wurden.



UNI EN ISO 14001: 2004 Certifica la riduzione dell'impatto ambientale derivante dalle varie fasi del processo produttivo. Ceramica Globo reimpiega pressochè a ciclo continuo, le acque utilizzate nella produzione ed effettua una continua ricerca di soluzioni tecniche atte a migliorare l'efficienza di scarico dei sanitari con riduzione del consumo d'acqua.

UNI EN ISO 14001:2004 Certifies the reduction of environmental impact coming from the different manufacturing processes. Ceramica Globo recovers, in a continuous cycle, the water used in its manufacturing processes and is always looking for technical solutions to improve drainage efficiency of the sanitary ware in order to reduce water consumption.

UNI EN ISO 14001: 2004 Zertifiziert die Reduzierung der Umweltauswirkungen, die sich aus den unterschiedlichen Phasen des Produktionsprozesses ableiten. Ceramica Globo verwendet beinahe im kontinuierlichen Zyklus das bei der Produktion verwendete Wasser wieder und führt eine kontinuierliche Forschung nach technischen Lösungen, die auf die Verbesserung der Effizienz der Abflüsse von Sanitäreinrichtungen mit einer Reduzierung des Wasserverbrauchs ausgerichtet sind, aus.



Ceramica Globo nel 2010 ha ottenuto la certificazione CSA dall'ente certificatore CSA International, per poter vendere i propri prodotti negli Stati Uniti ed in Canada, paesi per i quali sono richiesti test specifici, particolarmente impegnativi.

In 2010, Ceramica Globo obtained the CSA certificate from CSA International so that it can sell its products in the United States and Canada, countries that require specific, and particularly demanding, tests.

Ceramica Globo hat im Jahr 2010 die Zertifizierung CSA der Zertifizierungsbehörde CSA International erhalten, um seine Produkte in den USA und in Kanada verkaufen zu können. In diesen Ländern sind spezielle, besonders aufwändige Tests gefordert.

WaterMark Ceramica Globo nel 2009 ha ottenuto la certificazione WaterMark da Sai Global per poter vendere i propri prodotti sul mercato Australiano da sempre uno dei più difficili per standard qualitativi da rispettare.

Watermark In 2009, Ceramica Globo received the Watermark certificate from SAI Global, which allows it to sell its products in Australia, which has always been one of the hardest markets to crack due to the quality standards demanded.

WaterMark: Im Jahr 2009 hat Ceramica Globo das WaterMark-Zertifikat von Sai Global erhalten, um seine Produkte auch auf dem australischen Markt verkaufen zu können. Dieser ist seit jeher aufgrund der geforderten Qualitätsstandards der schwierigste.

SUSTAINABILITY

Il rispetto del territorio

Respect for the Environment / Der Respekt vor der Umwelt

La sensibilità nei confronti dell'emergenza ecologica mondiale ha spinto Ceramica Globo a porre l'ambiente al centro delle sue politiche economiche, sociali e industriali.

Ceramica Globo's sensitivity to the world's ecological emergency has prompted it to place the environment at the heart of its economic, social and industrial policies.

Die Sensibilität gegenüber dem weltweiten ökologischen Notstand hat Ceramica Globo dazu bewegt, die Umwelt in den Mittelpunkt der ökonomischen, sozialen und industriellen Maßnahmen zu stellen.

Ceramica Globo è un'azienda sostenibile, nel suo ruolo di industria e nel suo rapporto con il territorio che la ospita. Le unità produttive si inseriscono in modo armonico nel distretto delle ceramiche di Civita Castellana, un luogo dove la natura è considerata una ricchezza ed un patrimonio da rispettare e valorizzare. Tale volontà si concretizza con l'installazione di un notevole impianto fotovoltaico che permette di utilizzare energia pulita, così come le diverse scelte impiantistiche che consentono all'azienda di avere un minore impatto sull'ambiente.

Ceramica Globo is a sustainable company with regards to its industrial role and relationship with the surrounding territory. The production facility integrates harmoniously with the ceramic district of Civita Castellana, a place where nature is considered an asset and a heritage to be protected and valued. This desire is manifested in the installation of a large photo-voltaic system that allows using clean energy, and also in the different design options that allow the company to have less impact on the environment.

Ceramica Globo ist in seiner Rolle als Industrie und in seinem Verhältnis zu einer Umgebung ein nachhaltiges Unternehmen. Die Produktionseinheiten fügen sich auf harmonische Weise in den Keramikdistrikt von Civita Castellana, einem Ort, in dem die Natur als ein zu respektierender und aufzuwertender Reichtum und Erbe betrachtet wird, ein. Dieser Wunsch konkretisiert sich in der Installation einer beachtlichen Photovoltaik-Anlage, die es ermöglicht, saubere Energie zu verwenden, so wie in den verschiedenen Entscheidungen in Bezug auf den Anlagenbau, die dem Unternehmen erlauben, eine geringere Auswirkung auf die Umwelt zu haben.

Save Water

Come riduciamo il consumo d'acqua / How we reduce water consumption /
Wie wir den Wasserverbrauch reduzieren



Risparmiamo 10 metri cubi di acqua al giorno / *We save 10 cubic metres of water a day* / *Wir sparen 10 Kubikmeter Wasser am Tag*

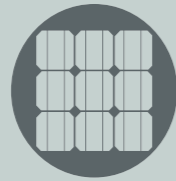

Produzione del 100% di acqua calda con pannelli solari / *100% of hot water is produced with solar panels* / *Produktion von 100% des Warmwassers durch Solarkollektoren*



Tutti i nostri vasi scaricano a 4,5/3 lt / *All our toilets discharge 4.5/3 litres of water* / *All unsere WCs lassen mit 4,5/3 l ab*



Oltre 2.200.000 lampadine spente per 4 ore / *More than 2,200,000 light bulbs switched off for 4 hours* / *Mehr als 2.200.000 für 4 Stunden ausgeschaltete Glühbirnen*



1500 tonnellate di vetro riciclato / *1500 tons of recycled glass* / *1500 Tonnen wiederverwertetes Glas*



2.000.000 km percorsi con un'automobile a benzina / *A distance of 2,000,000 km travelled by a petrol-powered car* / *2.000.000 km Fahrten mit einem Auto mit Benzinmotor*



Riutilizzo di tutte le acque industriali / *Reuse of all industrial water* / *Wiederverwendung des gesamten Industrierwassers*



Riutilizzo di acqua piovana / *Reuse of rainwater* / *Wiederverwendung des Regenwassers*

In termini di produzione è chiave l'utilizzo di materiali naturali e riciclati, di energia pulita e di processi che sono oggetto di frequente efficientamento e razionalizzazione. Le scelte progettuali alla base della creazione dei prodotti, inoltre, contemplan in modo irrinunciabile il rispetto delle risorse naturali, in primis il risparmio idrico. Tra le scelte green relative alla fase produttiva, si segnalano soprattutto la riduzione al minimo degli scarti di smalto grazie all'automatizzazione del processo di smaltatura e il recupero di calore dal forno di

In production terms, the use of natural and recycled materials, clean energy and rationalised and efficient processes are crucial. The design choices that go into creating the products also take into account the respect for natural resources, first and foremost, the saving of water. One of the eco-friendly choices relating to the production phase is the minimisation of glaze waste made possible by the automated glazing process and the recovery of heat from the kiln to heat the workplace. Ceramica Globo's

In Bezug auf die Produktion ist der Schlüssel die Verwendung von natürlichen und wiederverwerteten Materialien, sauberer Energie und Verfahren, die Gegenstand häufiger Effizienzsteigerung und Rationalisierung sind. Die Entwurfsentscheidungen an der Basis der Schaffung von Produkten berücksichtigen zudem auf unverzichtbare Weise den Respekt der natürlichen Ressourcen, in erster Linie die Wassereinsparung. Unter den grünen Entscheidungen in Bezug auf die Produktionsphasen werden dank der Automatisierung des Glasurverfahrens vor allem die

cottura per il riscaldamento dell'ambiente di lavoro. Grazie ad un moderno reparto, Ceramica Globo realizza internamente gli impasti per la produzione, utilizzando materie prime di alta qualità che vengono sottoposte a severi controlli. Inoltre, i singoli componenti degli impasti vengono analizzati per avere la certezza dell'assenza di agenti inquinanti prima della messa in produzione.

modern facility allows it to create the production mix internally, using the finest raw materials which are subjected to strict controls. In addition, each component of the mixture is analysed to ensure that it does not contain any contaminants before being put into production.

Reduzierung der Glasurabfälle auf ein Minimum und die Rückgewinnung von Wärme aus dem Brennofen für das Heizen der Arbeitsumgebung genannt. Dank einer modernen Abteilung realisiert Ceramica Globo intern die Mischungen für die Herstellung. Dazu verwendet das Unternehmen hochwertige Rohstoffe, die strengen Kontrollen unterliegen. Zudem werden die einzelnen Komponenten der Mischungen analysiert, um die Gewissheit zu haben, dass vor der Produktion keine Schadstoffe vorhanden sind.

Prodotto & processo

Product process / Produktionsvorgang

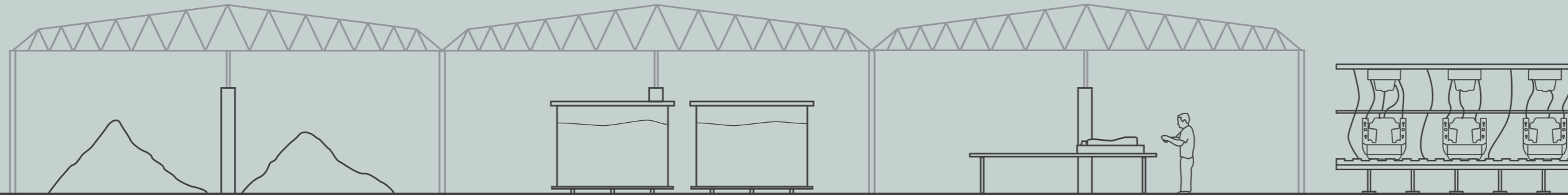

1 PREPARAZIONE IMPASTI / Mix preparation / Vorbereitung der Mischungen

Ceramica Globo grazie ai suoi moderni stabilimenti realizza l'impasto totalmente all'interno dell'azienda, utilizzando materie prime di prima qualità.

Ceramica Globo's modern facilities allows it to create the mix completely inside the company, using the finest raw materials.

Ceramica Globo realisiert dank seiner modernen Produktionsstätten die Mischung komplett innerhalb des Unternehmens. Dazu verwendet das Unternehmen hochwertige Rohstoffe.

- Utilizzo acqua piovana / Use of rainwater / Verwendung von Regenwasser
- Utilizzo vetro riciclato / Use of recycled glass / Verwendung von recyceltem Glas

Controllo / Control / Kontrolle:
- Ritiro / Collection / Abholung
- Deformazione / Deformation / Deformation
- Resistenza meccanica / Mechanical resistance / Mechanische Festigkeit

2 PREPARAZIONE SMALTI / Preparation of glaze / Vorbereitung der Glasuren

Gli smalti vengono testati in modo da garantire il giusto accordo con il supporto, il giusto colore e le resistenze previste da normativa.

The glazes are tested to ensure that they are suitable for the support, the right colour and that they meet the resistance standards.

Die Glasuren werden so getestet, dass sie die richtige Verbindung mit dem Träger, die richtige Farbe und die von der Gesetzgebung vorgesehene Festigkeit gewährleisten.

- Riduzione e riutilizzo degli scarti di smalto / Reduction and reuse of waste / Reduzierung und Wiederverwendung der Glasurabfälle

- Analisi assenza di inquinanti / Analysis for absence of contaminants / Analyse des Fehlens von Schadstoffen

3 PRODUZIONE STAMPI / Production of moulds / Produktion von Abdrücken

Gli stampi per la produzione sono realizzati in gesso, materiale che consente una facile estrazione del prodotto.

The production moulds are made of plaster, a material that allows easy extraction of the product.

Die Abdrücke für die Produktion werden aus Gips hergestellt, einem Material, das eine einfache Extraktion des Produktes ermöglicht.

- La produzione delle matrici e stampi interna consente un'altissima qualità / The in-house production of matrices and moulds allows delivering the highest quality / Die interne Produktion der Matrizen und Abdrücke erlaubt eine sehr hohe Qualität

4 PRODUZIONE ARTICOLI / Production of items / Produktion von Artikeln

Il materiale approvato viene inserito in appositi stampi in gesso e tramite il principio d'assorbimento d'acqua, viene creato il corretto spessore del prodotto.

The approved material is inserted in special plaster moulds, and the correct thickness of the product is created through the principle of water absorption.

Das genehmigte Material wird in die entsprechenden Gipsabdrücke gegeben und über das Prinzip der Wasseraufnahme wird die korrekte Stärke des Produktes geschaffen.

9 COTTURA ARTICOLI / Firing of items / Brennen der Artikel

La cottura dei prodotti avviene ad una temperatura di 1250°, e viene affiancata da fasi di riscaldamento e raffreddamento.

The firing of the products occurs at a temperature of 1250°, and is accompanied by heating and cooling phases.

Das Brennen der Produkte erfolgt bei einer Temperatur von 1250°, und wird von Heiz- und Kühlphasen flankiert.



8 SMALTATURA ARTICOLI / Glazing of items / Glasur der Artikel

Robot antropomorfi effettuano una verniciatura perfetta anche dei punti più nascosti.

Anthropomorphic robots guarantee perfect painting of the surface, even the most hidden points.

Anthropomorphe Roboter führen eine perfekte Lackierung auch der verstecktesten Stellen aus.



- Smaltatura perfetta / Perfect glazing / perfekte Glasur

7 COLLAUDO-RIFINITURA / Testing-finishing / Abnahmekontrolle-Endbearbeitung

I prodotti essiccati vengono ulteriormente controllati e rifiniti, ottenendo la massima perfezione.

The dried products undergo further checks and finishes, in order to obtain the highest perfection.

Die getrockneten Produkte werden zusätzlich kontrolliert und verfeinert, damit die maximale Perfektion erzielt wird.



6 ESSICCAZIONE ARTICOLI / Drying of items / Trocknung der Artikel

Per garantire la giusta compattezza del prodotto e velocizzare il processo di asciugatura, vengono utilizzati appositi box essiccatoi.

Special drying boxes are used to ensure correct compactness of the product and to speed up the drying process.

Um die richtige Kompaktheit des Produktes zu gewährleisten und den Trocknungsprozess zu beschleunigen, werden entsprechende Trockenboxen verwendet.

- Recupero del calore / Heat recovery / Wärmerückgewinnung

5 RIFINITURA ARTICOLI / Finishing of items / Endbearbeitung der Artikel

I nostri operatori rifiniscono manualmente ogni singolo prodotto. Quelli non idonei vengono riutilizzati per la produzione di nuovi impasti.

Our operators manually finish each product. Those that are unsuitable are reused to prepare new mixes.

Unsere Arbeiter verfeinern manuell jedes einzelne Produkt. Die nicht geeigneten werden für die Produktion neuer Mischungen wiederverwendet.

- Il prodotto non conforme viene rottamato e riutilizzato / Nonconforming products are scrapped and reused / Das nicht konforme Produkt wird verschrottet und wiederverwendet

- Manualità e professionalità degli operatori / The manual skill and professionalism of the operators / Handwerkliches Geschick und Professionalität der Arbeiter

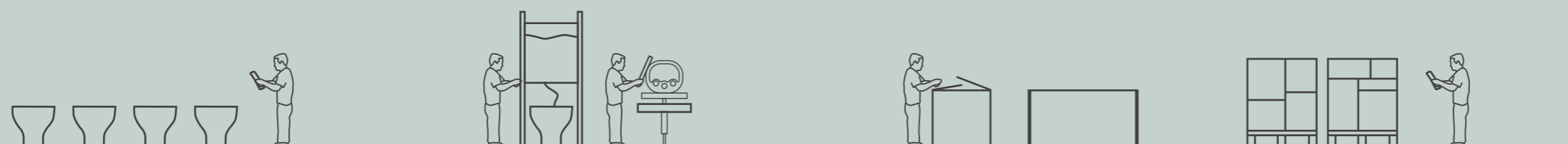

10 SELEZIONE / Selection / Auswahl

11 TEST / Testing / Test

12 IMBALLAGGIO E STOCCAGGIO / Packaging and storage / Verpackung und Lagerung

13 CONTROLLO QUALITÀ / Quality control / Qualitätskontrolle

14 PREPARAZIONE ORDINI E SPEDIZIONE / Preparation of order and shipping / Vorbereitung von Bestellungen und Versand



REFERENCES

Globo and Architecture

The right product for every need - Das richtige Produkt für jeden Anspruch

Referenza \ Reference \
Referenz: Chalet Fanes,
Alta Badia

Libertà di espressione per l'architetto

Freedom of expression for architects / Ausdrucksfreiheit für den Architekten

Grande versatilità, modularità e completezza delle collezioni permettono di stupire con creatività ogni target di riferimento, soddisfacendo in particolare le sempre più particolari e stringenti richieste del segmento contract.

The target audience is captivated by the versatility, modularity and completeness of the collections, whose creativity allows satisfying the increasingly more specific and demanding requirements of customers.

Große Vielseitigkeit, Modularität und Vollständigkeit der Kollektionen erlauben, jede Zielgruppe mit Kreativität zu überraschen, indem sie insbesondere die zunehmend speziellen und strengen Anforderungen des Contract-Segements befriedigen.



Dagli spazi individuali a quelli collettivi, dagli ambienti più esclusivi ai luoghi dell'hospitality, i prodotti Ceramica Globo si inseriscono perfettamente in ogni contesto, ingentilendo, nobilitando e rendendo confortevole il luogo più intimo di ogni spazio abitativo. In tutto il mondo sono presenti prestigiose installazioni in cui emerge la raffinatezza del brand Ceramica Globo, protagonista con tutta la sua bellezza e funzionalità. Ogni particolare acquista un valore di pregio che permette ad architetti e interior designer di progettare con creatività e semplicità la zona bagno a misura del cliente.

From individual spaces to collective spaces, from the most prestigious residences to accommodation facilities, the Ceramica Globo products fit perfectly into any context, adding style, beauty and comfort to the most intimate room of any home. Prestigious installations conveying the sophistication, functionality and beauty of the Ceramica Globo brand are present all over the world. Every detail acquires a prestigious value that allows architects and interior designers to use their creativity to design a bathroom that meets the need of every customer.

Von den individuellen Räumen zu den Gemeinschaftsräumen, von den exklusivsten Umgebungen zu Orten der Hospitality reihen sich die Produkte von Ceramica Globo perfekt in jeden Kontext ein und veredeln den intimsten Ort jeder häuslichen Umgebung und machen diesen komfortabel. Auf der gesamten Welt gibt es renommierte Installationen, in welchen sich die Raffinesse der Marke CeramicaGlobo profiliert, Protagonist mit ihrer ganzen Schönheit und Funktionalität. Jedes Detail erwirbt einen ansehnlichen Wert, der den Architekten und Innendesignern ermöglicht, mit Kreativität und Einfachheit den Badbereich kundenspezifisch zu planen.

Referenze

References / Referenzen

Italy



Roma
RESTAURANT / HOTEL
SHANGRI LA CORSETTI
Milano
HOTEL GLAM -
Milano
TOWNHOUSE DUOMO
Punta Ala
GALLIA PALACE HOTEL
Milano
HOTEL MAGNA PARS
SUITES
Alta Badia
CHALET FANES
Canosa
HOTEL QUEEN VICTORIA
Milano
CASCINA MERLATA - Villaggio
Expo 2015
Finale Ligure
HOTEL PUNTA EST
Milano
Nuova sede di Google Italia
(Palazzo-Ziggurat)
Roma
Nuova sede dell'A.S.I. (Agenzia
spaziale Italiana)
Milano
CAMPUS MONNERET
Milano
HOTEL MONTENAPOLEONE
SUITES
Torino
TURIN PALACE HOTEL



U.S.A.



New York
ARMANI CONCEPT STORE



France



Ronchamp
RIABILITAZIONE DEL SITO DI
RONCHAMP

Parigi
HOTEL RELAIS SAINT GERMAIN
Francia (Parigi)
HOTEL BELLEVUE



Switzerland



Zurigo
HOTEL EUROPE



Czech Republic



Karlovy Vary
HOTEL SAVOY



Maldives
DIAMONDS THUDUFUSHI Beach
& Water Villas



Singapore
CAPITOL SINGAPORE



BAR AND
RESTAURANTS



HOTEL AND SPA



PRIVATE RESIDENCES



PUBLIC SPACES AND
COMPANIES

Latvia



Riga
Opera Hotel & Spa



Korea



Seoul
THE PLAZA HOTEL
Seoul
THE BANYAN TREE CLUB AND
SPA
Seoul
The CHA Bio Complex
Seoul
THE CHAUM HOSPITAL

Turkey



Istanbul
10 KARAKÖY

China

EXPO SHANGHAI 2010

Collezioni

Collection / Kollektion

Stockholm p.42

Stone p.58

Forty3 p.80

Bowl+ p.102

4ALL p.122

Classic p.140

Genesis p.160

Bowl p.180

Relais p.198

Paestum p.218

Daily p.238

Grace p.252

New Arianna p.264

Le Pietre p.272

Docciardesia p.280

Docciaviva p.288

Docciabella p.294

Logo Rettango Plano Rondo p.298

Abaco p.300

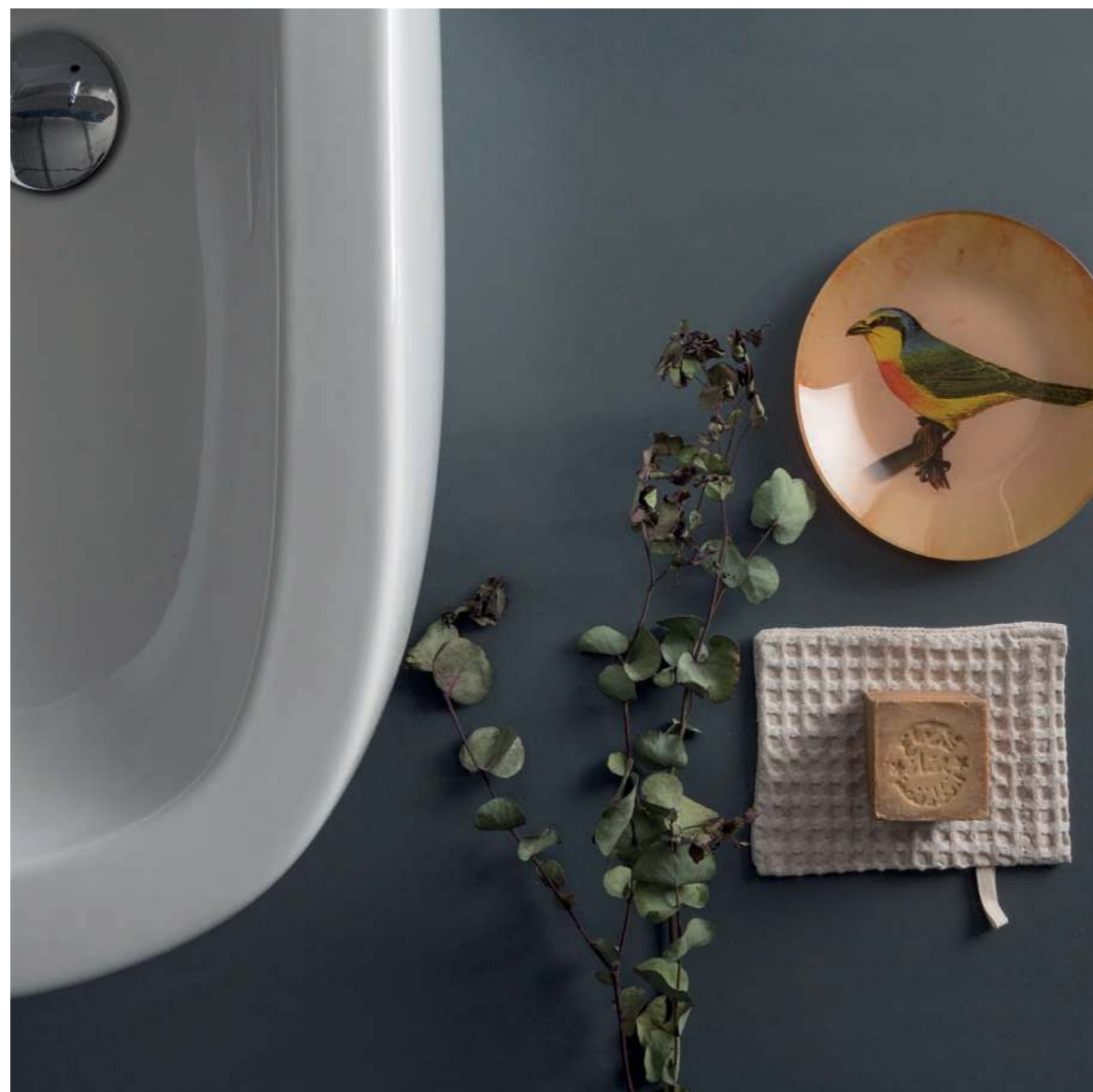

Fruire di eleganza e qualità sin dal risveglio e riscoprire ogni giorno la purezza dell'essenzialità. Ecco la prerogativa della serie Stockholm, che grazie alla dolcezza delle curve e alla raffinatezza delle linee nette, dona estrema armonia e semplicità al luogo più intimo della casa. Nasce così un paesaggio in cui il benessere si sposa con il comfort in un tripudio di bellezza che dura nel tempo.

Elementi plus presenti nella collezione Stockholm / Plus elements available in the Stockholm collection / Zusätzliche für die Kollektion Stockholm erhältliche Technologien

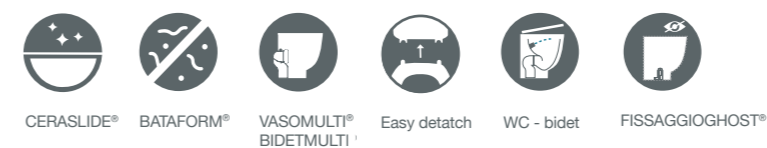

Stockholm

Nuovo paesaggio nel bagno

A new landscape in the bathroom / Eine neue Landschaft im Bad

To enjoy elegance and quality from the moment you wake up, and to rediscover the purity of essentiality day after day. This is the prerogative of the Stockholm series, whose soft curves and sophisticated lines give extreme harmony and simplicity to the most intimate room in the home. The result is a landscape where wellbeing combines with comfort in a blaze of timeless beauty.

Ab dem Aufwachen Eleganz und Qualität zu nutzen und jeden Tag die Reinheit der Wesentlichkeit wiederzuentdecken. Dies ist die besondere Eigenschaft der Serie Stockholm, die dank der Sanftheit der Kurven und der Raffinesse der klaren Linien dem intimsten Ort des Hauses extreme Harmonie und Einfachheit verleiht. So entsteht eine Landschaft, in der sich die Wellness mit dem Komfort einer Pracht aus Schönheit, die über die Zeit dauert, vereint.



▶
FO076.BI
 Lavabo sottopiano
 Under-top basin
 Unterbauwaschtisch
 75.34

▼
LAB02.BI
 Vaso/bidet sospeso
 Wall-hung wc/bidet
 Wand-WC/bidet
 58.37

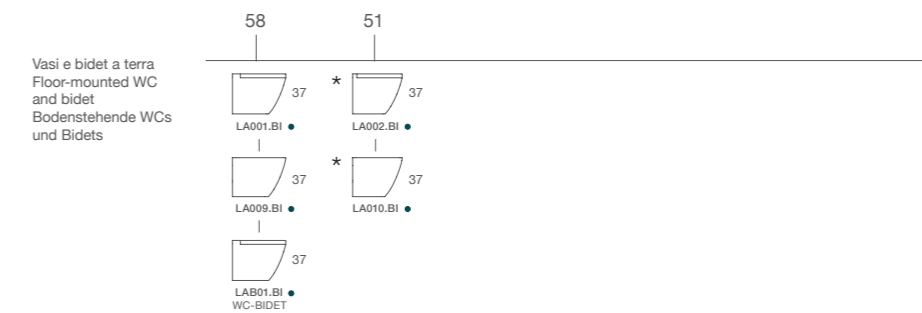
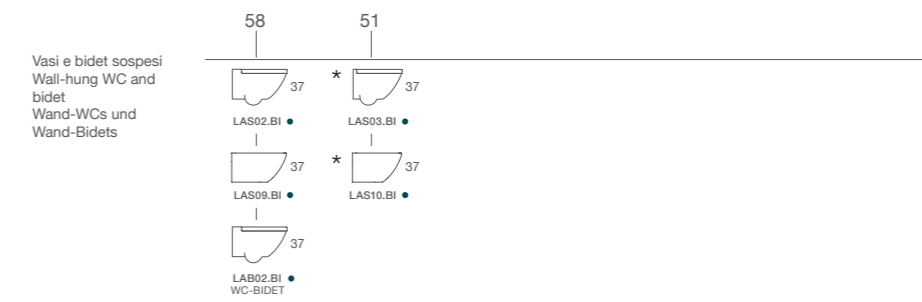
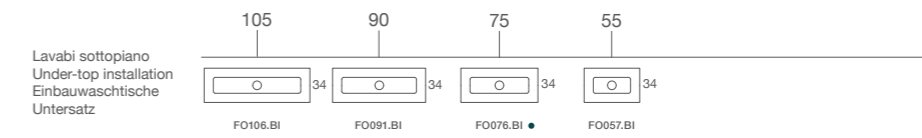
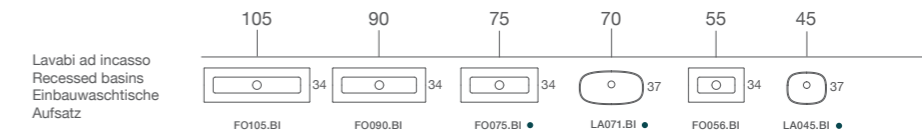
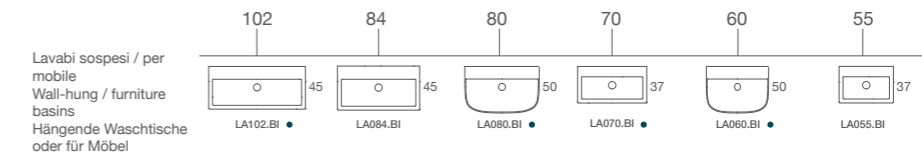

* Per la disponibilità degli articoli contrassegnati da (*) verrà fatta apposita comunicazione/
 For the availability of the items marked with (*) will be made specific communication /
 die Verfügbarkeit der durch (*) markierten Artikel wird durch eine Mitteilung bekanntgemacht.

• Articolo disponibile nelle colorazioni "Bagno di Colore"
 Article is available in the colors "Bagno di Colore"
 Dieser Artikel ist verfügbar in der Kollektion "Bagno di Colore"



◀
LA080.MA
 Lavabo sospeso
 Wall-hung basin
 Wand-Waschtisch
80.50



▲
LA071.BI
 Lavabo ad incasso
 Recessed basin
 Einbauwaschtisch
70.37





LAS02.BI - LAS09.BI

Vaso e bidet sospeso
Wall-hung wc and bidet
Wand Wc und Wand bidet
58.37



FO056.BI

Lavabo ad incasso
Recessed basin
Einbauwaschtisch
55.34



▼
LA080.BI

Lavabo sospeso
Wall-hung basin
Wand-Waschtisch
80.50

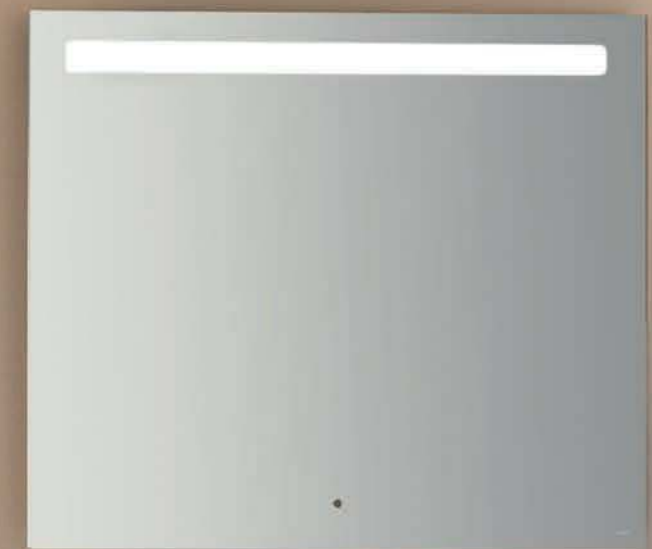

CERASLIDE®

Nuovo smalto ceramico / New ceramic glaze /
Neue Keramikglasur

Vantaggi / Benefits / Vorteile



Resistenza alle
macchie, all'abrasione
/ Resistant to stains
and abrasions /
Beständigkeit gegen
Flecken und Abrieb



Igiene più profonda /
Deeper hygiene /
Stärker in die Tiefe
gehende Hygiene



Colore più omogeneo
e brillante / Brighter
and more uniform
colour / Homogenere
und strahlendere
Farbe



BATAFORM®

Trattamento antibatterico / Antibacterial treatment /
antibakterieller Behandlung

Vantaggi / Benefits / Vorteile



L'attento controllo delle temperature nelle varie fasi di cottura, in un ciclo che arriva a 26 ore, garantisce al processo di sinterizzazione una perfetta omogeneità del prodotto, diminuendo la porosità e assicurando una maggiore resistenza alle macchie, allo sporco e all'abrasione: in questo modo i residui non aderiscono alle pareti scivolando via insieme all'acqua; per garantire una sempre maggiore attenzione all'igiene è stato sviluppato il trattamento antibatterico BATAFORM®, un processo insito alla fase di produzione che grazie al suo potere antimicrobico riduce notevolmente la presenza di germi e batteri. I test di laboratorio effettuati secondo gli standard internazionali conformi alla normativa ISO 22196:2011 confermano un drastico calo della presenza di microbi. Lo smalto Ceraslide® in sinergia con il trattamento antibatterico Bataform® dona ai sanitari una maggiore brillantezza, resistenza ed igiene con un particolare occhio di riguardo alla salute di chi vive l'ambiente bagno.

The careful control of temperatures in the various cooking stages, in a cycle that can last up to 26 hours, ensures perfect homogeneity of the product during the sintering process, reducing porosity and guaranteeing greater resistance against stains, dirt and abrasions. This means the residuals do not adhere to the walls but slide off with the water. The BATAFORM® antibacterial treatment was developed to ensure deeper hygiene. The antimicrobial power of this process during production significantly reduces the presence of germs and bacteria. Laboratory tests performed according to the international ISO 22196:2011 standards confirm a drastic decline in the presence of microbes. The Ceraslide® glaze in combination with the Bataform® antibacterial treatment gives sanitary fixtures greater gloss, resistance and hygiene for maximum comfort and wellbeing in the bathroom.

Die aufmerksame Überprüfung der Temperatur in den verschiedenen Brennphasen während eines Zyklus, der 26 Stunden erreicht, garantiert dem Verfahren des Sinterns eine perfekte Homogenität des Produkts unter Verringerung der Porosität und Gewährleistung einer größeren Beständigkeit gegen Flecken, Schmutz und Abrieb: auf diese Weise haften die Reste nicht an den Wänden und gleiten zusammen mit dem Wasser ab; um der Hygiene eine stets größerer Aufmerksamkeit zu gewährleisten, wurde eine antibakterielle Behandlung entwickelt, BATAFORM®. Dies ist ein Verfahren, das in der Produktionsphase enthalten ist und dank seiner antimikrobiellen Kraft das Vorhandensein von Keimen und Bakterien bemerkenswert reduziert. Die Labortests, die nach internationalen Standards gemäß der Richtlinie ISO 22196:2011 durchgeführt wurden, bestätigen einen drastischen Rückgang des Vorhandenseins von Mikroben. Die Glasur Ceraslide® in Synergie mit der antibakterielle Behandlung Bataform® verleiht den Sanitärkeramiken einen stärkeren Glanz, Beständigkeit und Hygiene mit besonderem Augenmerk auf die Gesundheit desjenigen, der das Badambiente lebt.



LA001.BI - LA009.BI
 Vaso e bidet a terra
 Floor-mounted WC and bidet
 Bodenstehende WC und Bidet
58.37



LA102.BI
 Lavabo sospeso
 Wall-hung basin
 Wand-Waschtisch
102.45





◀
FO105.BI
Lavabo ad incasso
Recessed basin
Einbauwaschtisch
105.34



▼
LA001.BI - LA009.BI
Vaso e bidet a terra
Floor mounted wc and bidet
Bodenstehende WC und Bidet
58.37



Stone

Everyday Comfort

Everyday bathroom rituals - Alltägliche Rituale im Bad

Morbidi contrasti di forme e una fusione di linee curve e diritte caratterizzano gli elementi appartenenti alla Collezione Stone, dove l'innovazione si integra perfettamente con le problematiche di utilizzo dello spazio contemporaneo. Forte di una rivisitazione estetica mirata ad una forma più rigorosa, i sanitari Stone si presentano in nuove dimensioni e profondità. I sanitari a terra sono del tipo per installazione a filo parete con possibilità di utilizzo del sistema di scarico MULTI.

Elementi plus presenti nella collezione Stone / Plus elements available in the Stone collection / Zusätzliche für die Kollektion Stone erhältliche Technologien

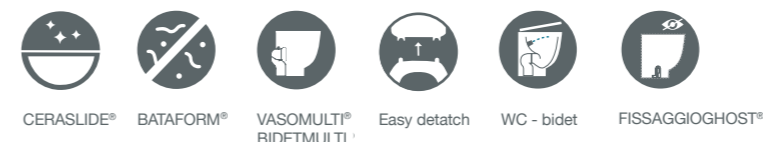

The Stone Collection is characterised by soft contrasting shapes and a blend of curved and straight lines, where innovation integrates perfectly with the problems associated with today's use of space. With a restyling aimed at creating a more rigorous look, the Stone sanitary fixtures come in new sizes and depths. The back-to-wall installation of toilets and bidets allows using the MULTI flushing system.

Weiche Kontraste der Formen und eine Verschmelzung von geschwungenen und geraden Linien zeichnen die Elemente der Kollektion STONE aus. Hier ergänzt sich die Innovation perfekt mit den Problemen der Nutzung des modernen Ambientes. Gestärkt durch eine ästhetische Neuinterpretation, die auf eine strengere Form abzielt, zeigen sich die Sanitärkeramiken Stone mit neuen Abmessungen und Tiefen. Die bodenstehenden Sanitärkeramiken sind für die wandbündige Installation mit der Möglichkeit der Verwendung des Abflusssysteme MULTI gedacht.

▼
STS03.BI - STS10.BI

Vaso e bidet sospesi
Wall-hung WC and bidet
Wand Wc und Wand bidet
52.36

▼
SSN14.BI

Lavabo sospeso
Wall-hung basin
Wand-Waschtisch
85.48





SSN14

Lavabo sospeso
Wall-hung basin
Wand-Waschtisch
85.48



STS02.BI - STS09.BI

Vaso e bidet sospesi
Wall-hung WC and bidet
Wand Wc und Wand bidet
56.36

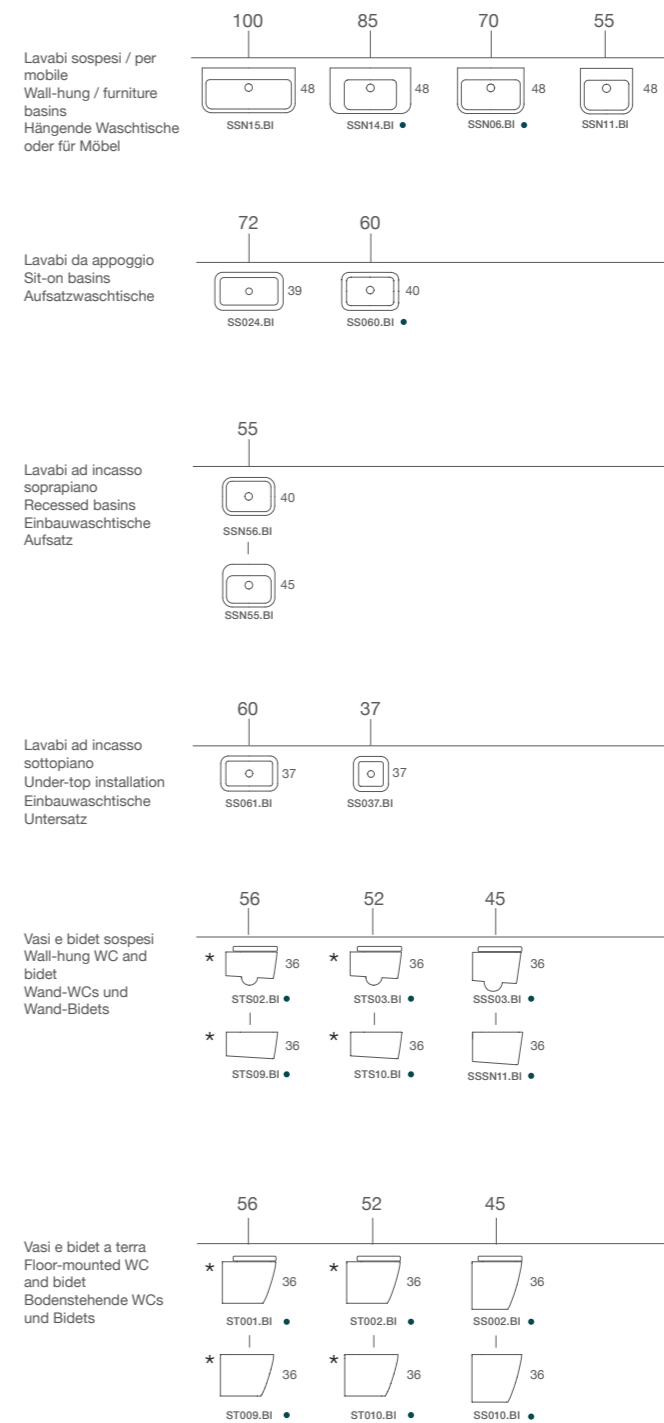

* Per la disponibilità degli articoli contrassegnati da * verrà fatta apposita comunicazione /
For the availability of the items marked with (*) will be made specific communication /
die Verfügbarkeit der durch * markierten Artikel wird durch eine Mitteilung bekanntgemacht.

• Articolo disponibile nelle colorazioni "Bagno di Colore"
Article is available in the colors "Bagno di Colore"
Dieser Artikel ist verfügbar in der Kollektion "Bagno di Colore"



SSN14.BI

Lavabo sospeso con base (SSM85Y001)
finitura bianco ceramico
Wall-hung basin with base (SSM85Y001)
white ceramic finish
Wand-Waschtisch mit wandhängendem
Unterschrank (SSM85Y001) Keramik weiß Finish
85.48

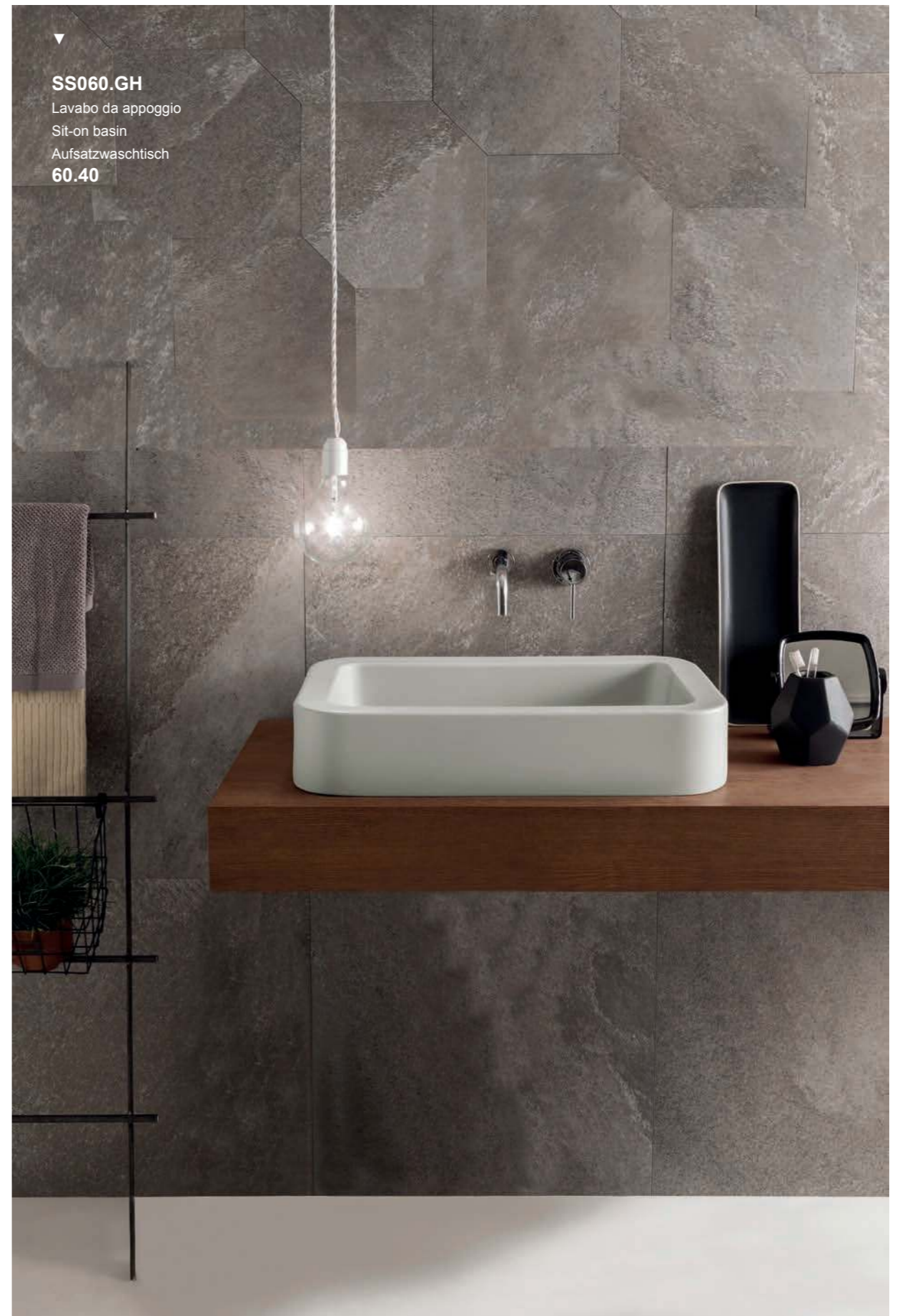

SS060.GH

Lavabo da appoggio
Sit-on basin
Aufsatzwaschtisch
60.40

▼
SSN06.BI

Lavabo sospeso
Wall-hung basin
Wand-Waschtisch
70.48

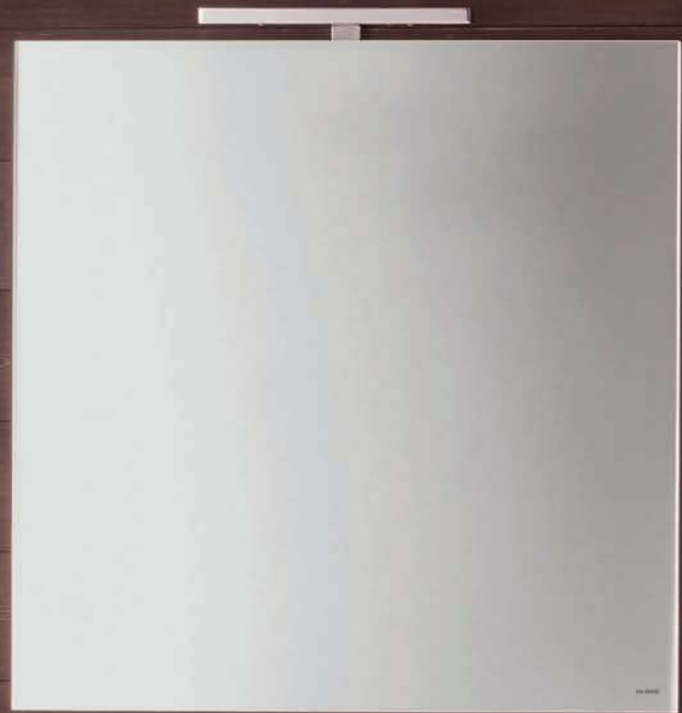

▼
ST002.BI - ST010.BI

Vaso e bidet a terra
Floor-mounted WC and bidet
Bodenstehende WC und Bidet
52.36





Easy Detach

Il sistema di cerniere a sgancio rapido
/ The quick-release hinge system / Das
Scharniersystem mit Schnellbefestigung

Vantaggi / Benefits / Vorteile



Facilità di pulizia /
Easy to clean /
Einfache Reinigung

Le nuove cerniere a sgancio rapido, permettono di sganciare il copriaso con un gesto semplice e veloce. Infatti tirando il sedile verso l' alto questo si sgancia dai piantoni. Rimettendo le due cerniere sui piantoni e spingendo queste si riportano in posizione bloccandosi. Questo sistema consente sia di sganciare e riagganciare il copriaso velocemente sia di pulirlo comodamente in ogni zona. Questa cerniera è disponibile sia nella versione normale che a discesa rallentata

The new quick-release hinges allow unhooking the seat with a quick and easy gesture thanks to the special hinges. In fact, the toilet seat can be easily unhooked by pulling the seat upwards. Put the two hinges back on the posts and push to lock back into place. This system allows speeding up the assembly and disassembly of the toilet seat, making it easier to clean it and the surrounding areas which are often difficult to clean. This hinge is available in the normal version and in the soft-close version.

“ Durch die neuen Scharnieren mit dem Quick-release-System können Sie den Toilettensitz einfach und schnell abnehmen. Wenn Sie den Sitz nach oben ziehen, kann man diesen aus den Halterungen herausziehen. Wenn Sie die Scharnieren auf die Halterungen wieder stellen und nach unten drücken, dann werden diese wieder an ihren Sitz befestigt. Dieses System ermöglicht den Toilettensitz schnell abzunehmen, so dass man eine tiefe und einfache Reinigung bei allen WC-Sitzteilen durchführen kann. Diese Scharnieren sind sowohl in der traditionellen Version als auch mit dem Absenkautomatik erhältlich”

▼
SSN11.BI

Lavabo sospeso
Wall-hung basin
Wand-Waschtisch
55.48

▼
SSS03.BI - SSS11.BI

Vaso e bidet sospesi
Wall-hung WC and bidet
Wand Wc und Wand bidet
45.36



▼
SS002.CA - SS010.CA

Vaso e bidet a terra colore CAMOSCIO
Floor mounted WC and bidet CAMOSCIO colour
Bodenstehende WC und Bidet CAMOSCIO Farbe
45.36

▼
SS060.CA

Lavabo da appoggio colore CAMOSCIO
Sit-on basin CAMOSCIO colour
Aufsatzwaschtisch CAMOSCIO Farbe
60.40

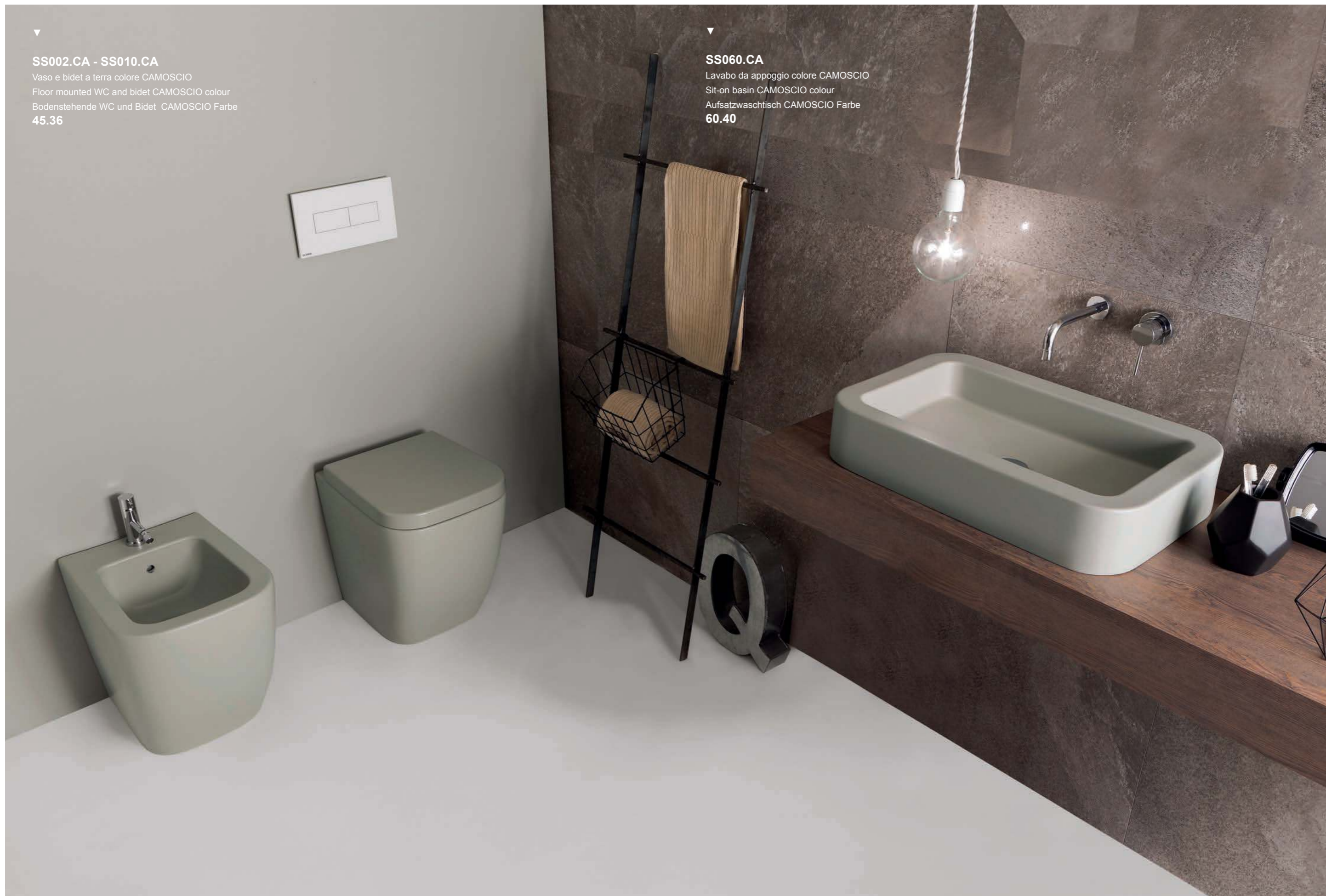



◀
ST001.BI - ST009.BI
Vaso e bidet a terra
Floor mounted WC and bidet
Bodenstehende WC und Bidet
56.36



▼
SSN14.BI
Lavabo sospeso
Wall-hung basin
Wand-Waschtisch
85.48



SSN15.BI

Lavabo sospeso
Wall-hung basin
Wand-Waschtisch
100.48



STS02.BI - STS09.BI

Vaso e bidet sospesi
Wall-hung WC and bidet
Wand Wc und Wand bidet
56.36

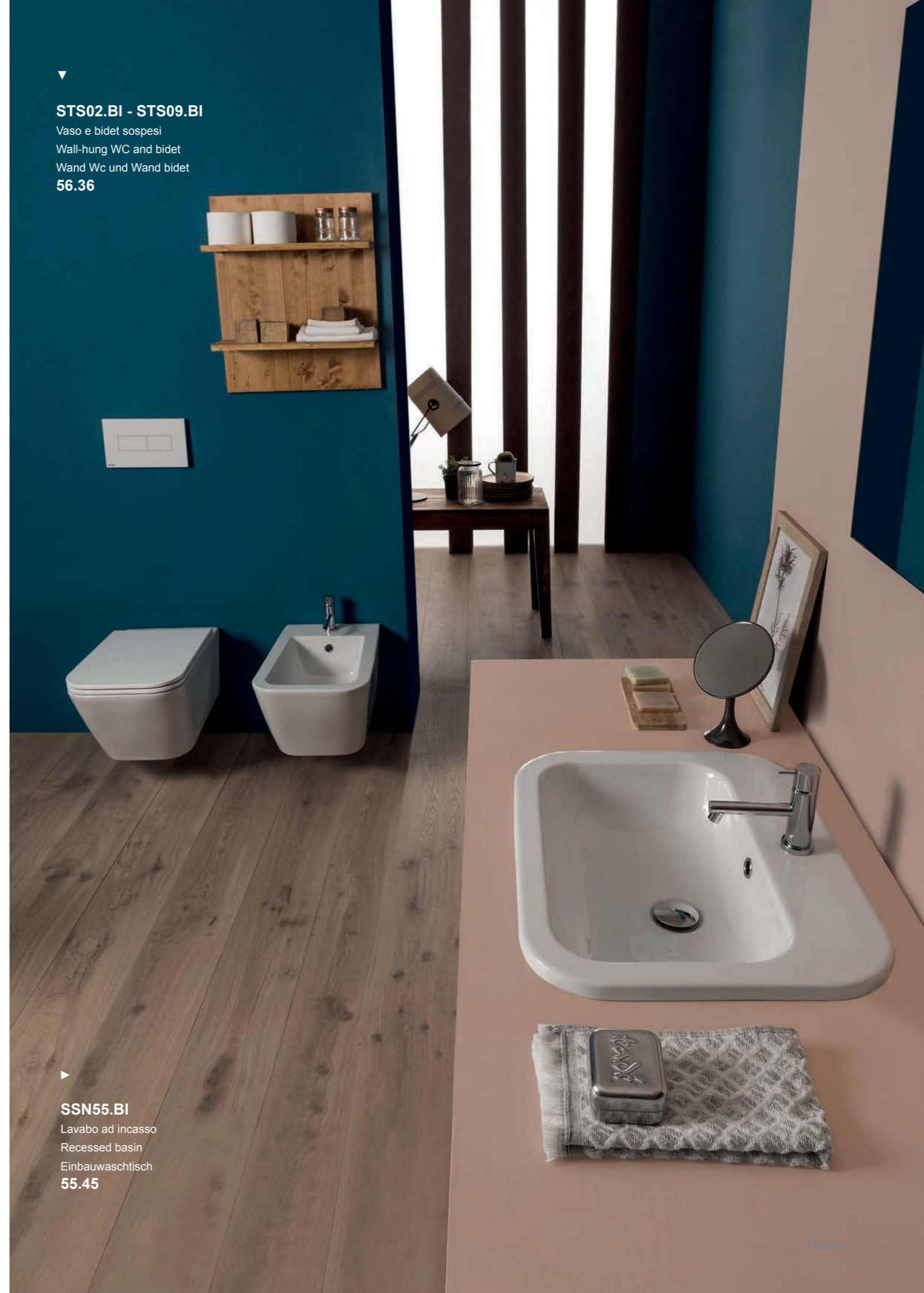

SSN55.BI

Lavabo ad incasso
Recessed basin
Einbauwaschtisch
55.45



SSS03.BI - SSS11.BI

Vaso e bidet sospesi
 Wall-hung WC and bidet
 Wand Wc und Wand bidet
45.36



SSN11.BI

Lavabo sospeso
 Wall-hung basin
 Wand-Waschtisch
55.48

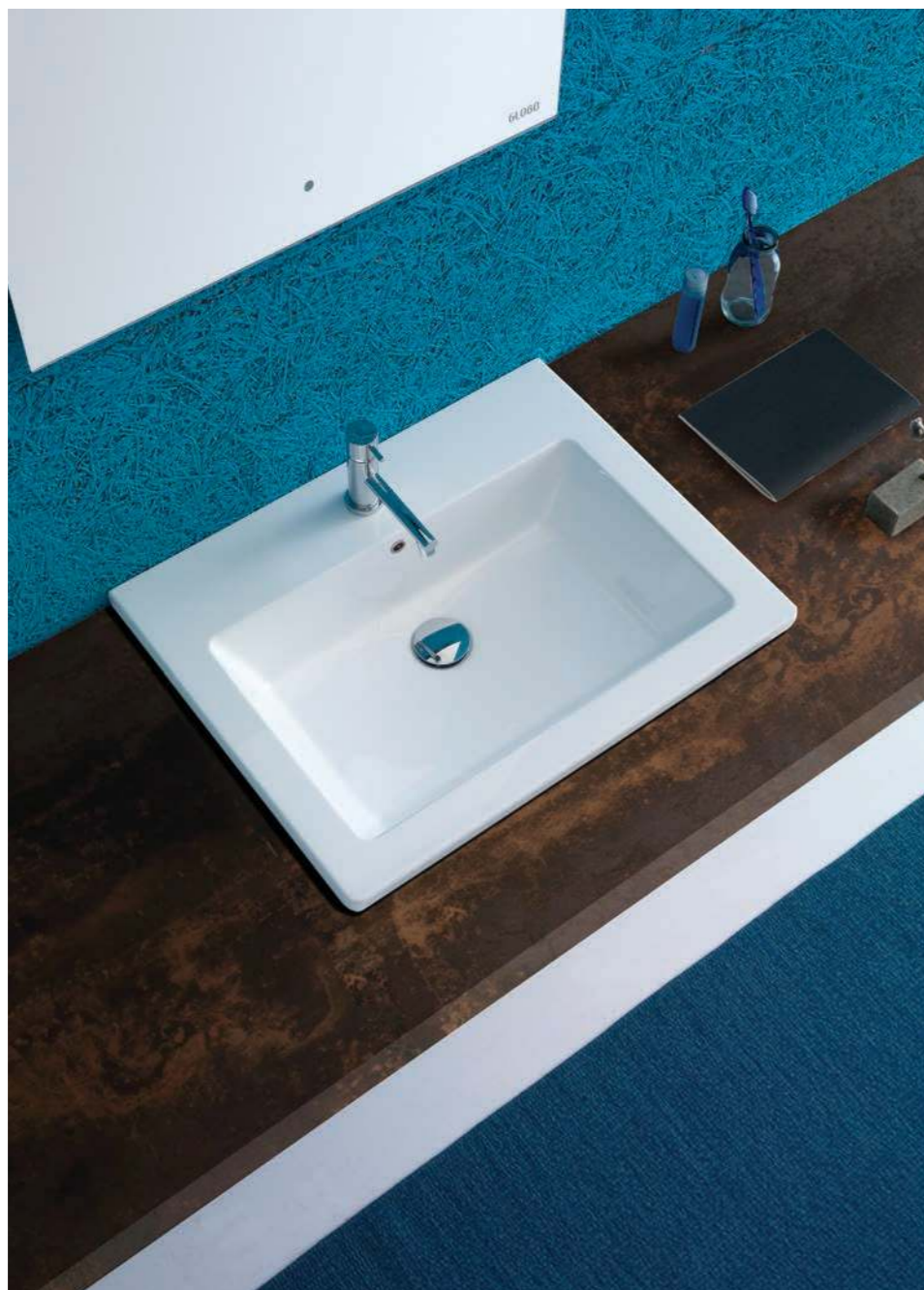

Forty3

Essenzialità moderna

Basic modern style - Moderne Wesentlichkeit

Dalle linee decise dell'architettura moderna e ispirata all'essenzialità nasce Forty3, una linea completa di lavabi, sanitari e arredi. Il disegno si caratterizza per le sue forme lineari e contemporanee. I sanitari a terra, disponibili nelle misure 52 e 57 cm, sono i primi presenti sul mercato con l'innovativo sistema FISSAGGIOGHOST®, che consente di eliminare i fori di fissaggio, migliorando notevolmente l'estetica del prodotto.

Elementi plus presenti nella collezione Forty3 / Plus elements available in the Forty3 collection / Zusätzliche für die Kollektion Forty3 erhältliche Technologien



Forty3 has been created by matching the decisive features of contemporary architecture and essentiality. It is a comprehensive selection of washbasins, WC and furniture. Its design is characterized by linear and contemporary shapes. The Floor-mounted version, available in the 52 and 57 cm sizes, is the first and leading-edge item on the market to have the innovative hidden fixing system FISSAGGIOGHOST®, which enables to eliminate all fixing holes, improving considerably the aesthetics of the product.

Durch die markanten Linien der modernen Architektur und die Wesentlichkeit inspiriert, entsteht Forty3, eine komplette Linie aus Waschbecken, Sanitärkeramiken und Badmöbeln. Das Design zeichnet sich durch seine linearen und modernen Formen aus. Die bodenstehenden Sanitärkeramiken, die in den Maßen 52 und 57 cm erhältlich sind, sind die ersten mit dem innovativen System FISSAGGIOGHOST® auf dem Markt. Dieses ermöglicht die Beseitigung der Befestigungslöcher und verbessert dadurch auf bemerkenswerte Weise die Ästhetik des Produkts.



▲
FOS03.BI - FOS10.BI

Vaso e bidet sospesi
Wall-hung WC and bidet
Wand Wc und Wand bidet
52.36



▲
FO125.BI

Lavabo sospeso con base (FOM1Y904) finitura salice
Wall-hung basin whit base (FOM1Y904) salice finish
Wand-Waschtisch mit wandhängendem Unterschrank (FOM1Y904) salice Finish
125.47.h50

▼
FOS02.BI - FOS09.BI

Vaso e bidet sospesi
Wall-hung wc and bidet
Wand Wc und Wand bidet
57.36

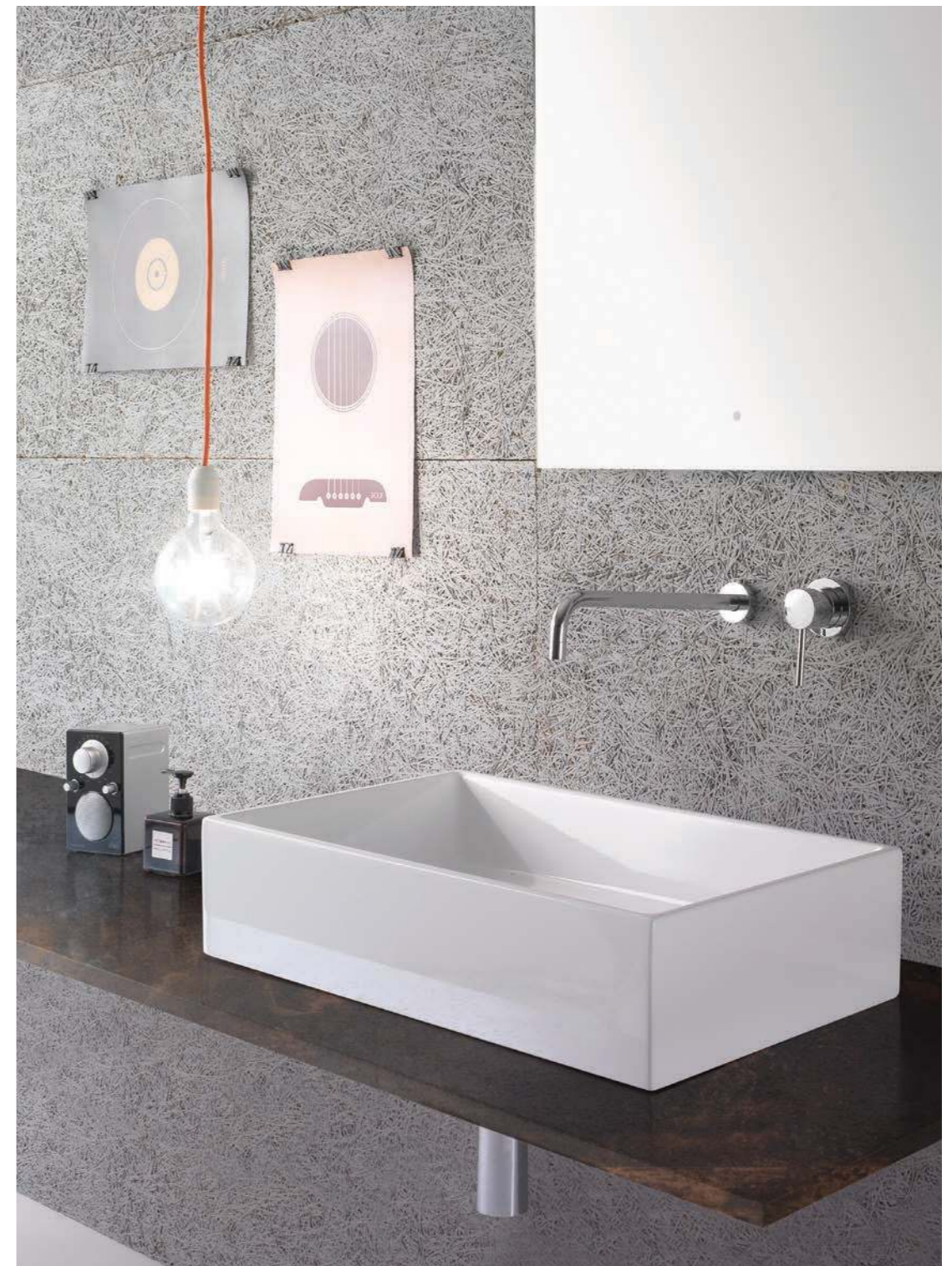

FO050.BI

Lavabo da appoggio
Sit-on basin
Aufsatzwaschtisch
50.37

▼
FO063.BI

LAVABATOIO®

Lavabo con vasca alta
e strizzatoio

Basin with high sink and
wringer

Waschtisch mit tiefem
Becken und Wringer

60.50



FO063.BI

Lavabo sospeso con base (FOM4Y905) finitura betulla

Wall-hung basin whit base (FOM4Y905) betulla finish

Wand-Waschtisch mit bodenstehendem Unterschrank (FOM1Y904) betulla Finish

60.50



FO001.BI - FO009.BI

Vaso e bidet a terra, completi di FISSAGGIOGHOST®

Floor mounted wc and bidet, FISSAGGIOGHOST® fixing included

Bodenstehende WC und Bidet, Komplett mit Befestigungen FISSAGGIOGHOST®

57.36



FO064.BI

Lavabo ad incasso soprapiano

Recessed basin

Einbauwaschtisch

60.47





▼
FO058.BI
Lavabo ad incasso soprapiano
Recessed basin
Einbauwaschtisch
58.42



▼
FOS03.BI - FOS10.BI
Vaso e bidet sospesi
Wall-hung WC and bidet
Wand Wc und Wand bidet
52.36



▲
F0035.BI
Lavabo da appoggio
Counter-top basin
Aufsatzwaschtisch
Ø 35



▲
FOS04.BI - FOS12.BI
Vaso e bidet sospesi
Wall-hung WC and bidet
Wand Wc und Wand bidet
43.36



FO002.BI - FO010.BI

Vaso e bidet a terra, completi di FISSAGGIOGHOST®

Floor mounted wc and bidet, FISSAGGIOGHOST® fixing included

Bodenstehende WC und Bidet, Komplet mit Befestigungen FISSAGGIOGHOST®

52.36



FISSAGGIOGHOST®

Il sistema di fissaggio invisibile dei vasi e bidet a terra / The invisible fixing system for floor-mounted toilets and bidets / Das unsichtbare Befestigungssystem von bodensehenden WCs und Bidets

Il sistema di fissaggio dei vasi e bidet a terra è completamente nascosto, grazie a un brevetto sviluppato ed ingegnerizzato da Ceramica Globo. Il sanitario è così saldamente fissato al pavimento lasciando il design del pezzo perfettamente intatto senza interruzioni.

The fixing system of the toilets and bidets is completely hidden, thanks to a patent developed and engineered by Ceramica Globo. The sanitaryware is therefore fixed securely to the floor leaving the design perfectly intact without interruptions.

Das Befestigungssystem für bodensehende WCs und Bidets ist dank eines von Ceramica Globo entwickelten und konstruierten Patents vollständig verborgen. Die Sanitärkeramik ist somit fest am Boden befestigt und erhält dabei perfekt das Design des Stückes ohne Unterbrechungen.





▼
FOS04.BI
Vaso sospeso
Wall-hung WC
Wand Wc
43.36



▼
FO030.BI
Orinatoio sospeso con fori per coperchio
Wall-hung urinal with holes for cover
Wand-Urinal mit Lochern für Deckel
37.34

▼
FO003.BI

Vaso monoblocco con cassetta (FO003.BI)
Close couple WC with cistern (FO003.BI)
WC-Kombination mit Spülkasten (FO003.BI)

58.36



FOS11.BI

Bidet sospeso con erogazione acqua dalla ceramica
Wall-hung bidet with water supplying from ceramic
Wand-Bidet Mit integrierter Wasserversorgung in der
Keramik

43.36

Bowl+ Flusso creativo

Creative flow - Kreativer Fluss

E' un progetto completo di lavabi, mobili, specchiere e sanitari nella versione a terra e sospesa. Elementi che si muovono tra l'arte e il prodotto industriale, dando la percezione di un flusso creativo sempre in movimento. Il disegno è decisamente originale, caratterizzato da bordi molto sottili, motivo ispiratore di tutta la collezione. La superficie di appoggio dei lavabi è ampia ed estremamente pulita, nessun orpello, né scanalatura a vantaggio dell'ergonomicità.

Elementi plus presenti nella collezione Bowl+ / Plus elements available in the Bowl+ collection / Zusätzliche für die Kollektion Bowl+ erhältliche Technologien



CERASLIDE®



BATAFORM®



SENZABRIDA®



VASOMULTI®
BIDETMULTI®



WC - bidet



FISSAGGIOGHOST®

It's a collection composed of elements that "move" between art and industrial product, giving a sense of perpetual creative flow. The thinness of the edges, together with a new kind of design, represents the motive of the collection. The basins lay on a wide and extremely clear surface with no tinsels and flutes. Each basin can be paired with a back-lit and polished edge mirror, provided with a touch switch.

Es handelt sich um ein Projekt, komplett mit Waschbecken, Badmöbeln, Wandspiegeln und Sanitärkeramiken in der bodenstehenden und wandhängenden Ausführung. Die Elemente bewegen sich zwischen Kunst und Industrieprodukt und verleihen der Wahrnehmung einen kreativen Fluss, der sich stets in Bewegung befindet. Das Design ist äußerst originell und zeichnet sich durch sehr feine Ränder aus, ein inspirierendes Motiv der gesamten Kollektion. Die Auflagefläche der Waschbecken ist groß und extrem rein, es gibt weder Schnickschnack noch Riffelungen zum Vorteil der Ergonomie.



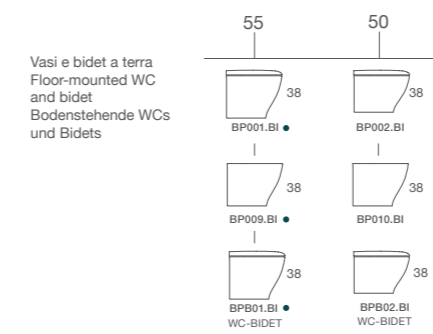
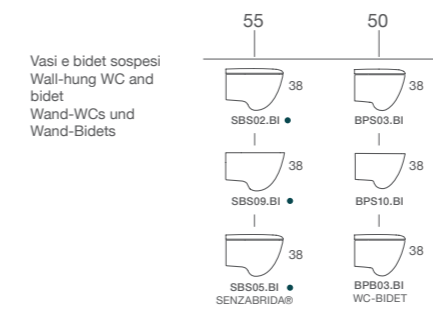
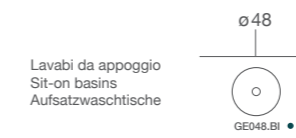
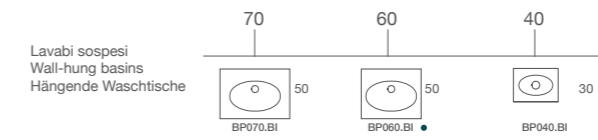
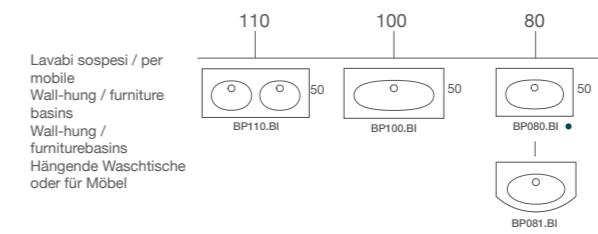

• Articolo disponibile nelle colorazioni "Bagno di Colore"
Article is available in the colors "Bagno di Colore"
Dieser Artikel ist verfügbar in der Kollektion "Bagno di Colore"



▲
BP110.BI
Lavabo sospeso
Wall-hung basin
Wand-Waschtisch
110.50



▲
BP002.BI - BP010.BI
Vaso e bidet a terra
Floor mounted wc and bidet
Bodenstehende WCs und Bidets
50.38



▲
GE048.BI
Lavabo da appoggio
Sit-on basin
Aufsatzwaschtisch
ø 48



▲

BP081.BI
 Lavabo sospeso con base (BPM4Y907) finitura desert
 Wall-hung basin with base (BPM4Y907) desert finish
 Wand-Waschtisch mit wandhängendem Unterschrank (BPM4Y907) Finish desert
80.50



SBS02.BI - SBS09.BI

Vaso e bidet sospesi
Wall-hung WC and bidet
Wand WC und wand bidet
55.38





BP040.BI
Lavabo sospeso
Wall-hung basin
Wand-Waschtisch
40.30

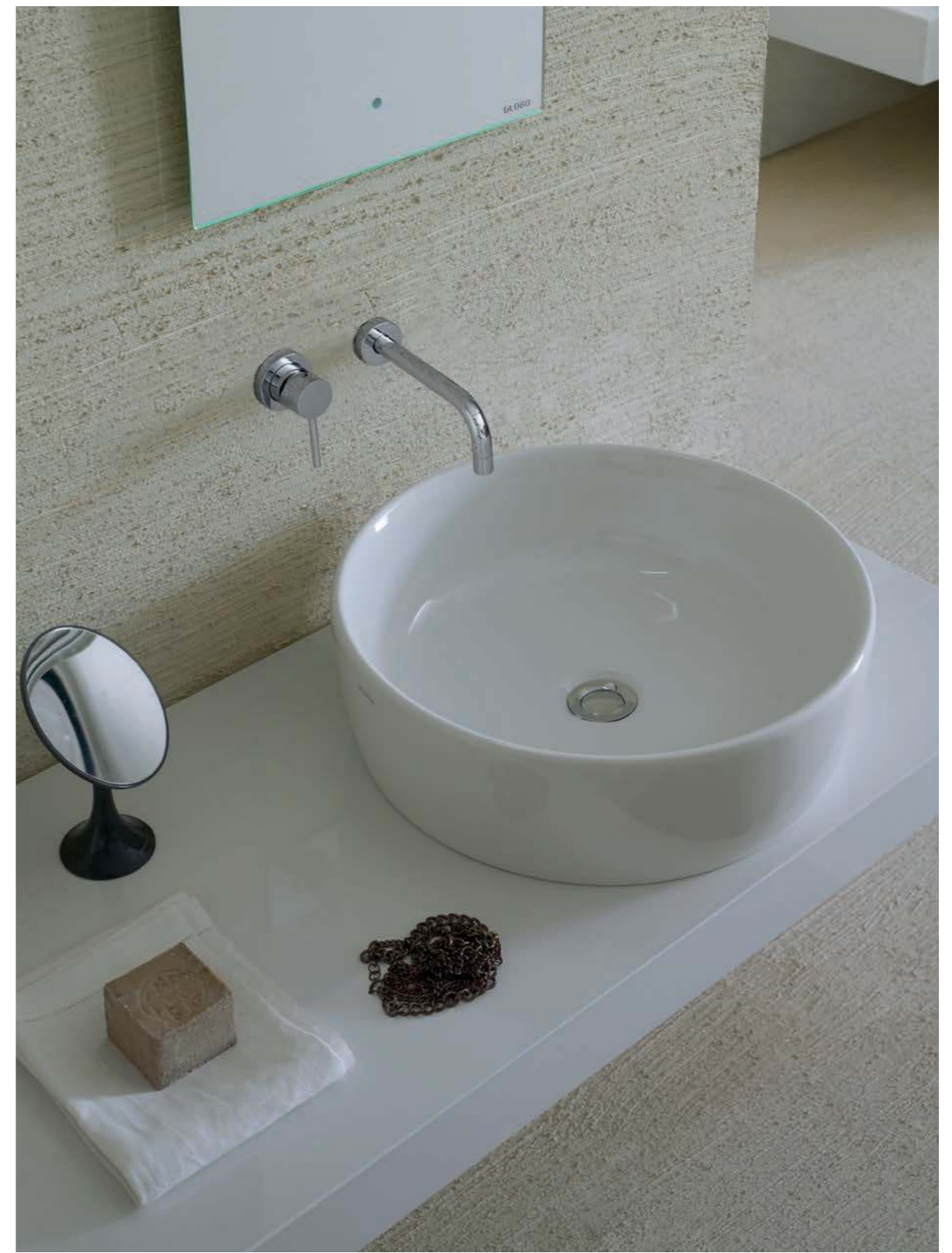

GE048.BI
Lavabo da oppoggio
Sit-on basin
Aufsatzwaschtisch
ø 48

▼
SBS02.BI
Vaso sospeso
Wall-hung WC
Wand WC
55.38

▼
SBS09.BI
Bidet sospeso
Wall-hung bidet
Wand bidet
55.38

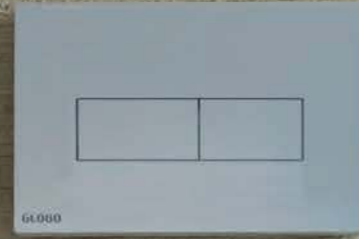



VASOMULTI® BIDETMULTI®

Vaso e bidet a terra / Floor-mounted wc e bidet /
Bodenstehendes WC und Bidet



Adatto per le ristrutturazioni/ Suitable
for new installations / Für Sanierungen
geeignet Klein, aber großartig

MULTI® è l'innovativo sistema ideato da Ceramica Globo che consente di allacciarsi su scarichi e attacchi idraulici esistenti, per l'installazione di vasi e bidet a terra filo parete. Il VASOMULTI® può essere installato sul vecchio scarico, generalmente posto ad una distanza da 6 a 20 cm. dalla parete, mediante l'utilizzo di 3 diverse curve tecniche. I BIDETMULTI® sono, invece, realizzati in modo da ospitare al suo interno i vecchi allacci idraulici, nascondendoli alla vista. Il sistema MULTI® offre l'opportunità di ristrutturare il bagno senza sostenere le spese per il rifacimento degli scarichi, degli allacci idraulici e talvolta anche dei rivestimenti.

VASOMULTI®

Prima della ristrutturazione. Vaso da sostituire /
Before new installation. Toilet to be replaced /
Vor der Sanierung. Zu ersetzendes WC

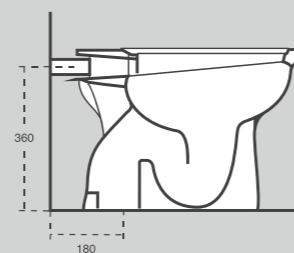

VASOMULTI® Grazie al raccordo eccentrico e curva
tecnica si adegua alle quote preesistenti /
VASOMULTI. The eccentric fitting and technical curve
allows it to adapt easily to existing heights /
VASOMULTI® Dank des exzentrischen Anschlusses
und des Abflussbogens passen sie sich den
bestehenden Maßen an

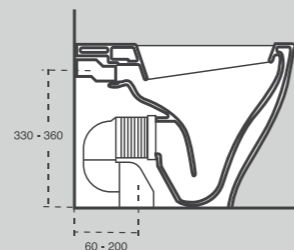

BIDETMULTI®

Prima della ristrutturazione. Bidet da sostituire /
Before installation. Bidet to be replaced /
Vor der Sanierung. Zu ersetzendes Bidet

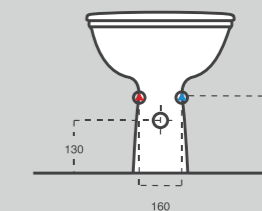

BIDETMULTI® Grazie alla sua apertura posteriore
si adegua alle quote preesistenti /
BIDETMULTI. Its rear opening allows it to adapt to
existing heights /
BIDETMULTI® Dank der hinteren Öffnung passen
sie sich den bestehenden Maße an

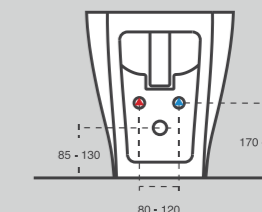



4ALL Design per tutti

Design for everyone - Design für alle

4ALL è la nuova Collezione “per tutti” che comprende una ampia varietà di articoli caratterizzati da un design stilisticamente e tecnologicamente avanzato e offerti ad un prezzo decisamente contenuto. I lavabi presentano un ampio bacino e sono caratterizzati da bordi molto sottili; i sanitari sospesi non lasciano vedere alcun foro di fissaggio. I sanitari a terra sono del tipo per installazione a filo parete con possibilità di utilizzo del sistema di scarico MULTI.

Elementi plus presenti nella collezione 4ALL / Plus elements available in the 4ALL collection / Zusätzliche für die Kollektion 4all erhältliche Technologien



CERASLIDE®



BATAFORM®



SENZABRIDA®



VASOMULTI®
BIDETMULTI®



WC - bidet



FISSAGGIOGHOST®

4ALL is the new collection “for everyone” which includes a huge variety of items characterized by an advanced design and by a moderate price. The basins have wide sinks and are characterized by thin edges. The wall hung pans do not show any fixing hole. The floor mounted pans (back to wall) can also be used with MULTI drain system.

4ALL ist die neue Kollektion “für alle”, die eine große Bandbreite von Artikeln umfasst, die sich durch ein stilistisch und technologisch fortschrittliches Design auszeichnen und zu einem ausgesprochen günstigen Preis angeboten werden. Die Waschbecken verfügen über große Becken und zeichnen sich durch sehr schmale Ränder aus; die wandhängenden Sanitärkeramiken ermöglichen das Verbergen der Befestigungslöcher. Die bodenstehenden Sanitärkeramiken sind für die wandbündige Installation gedacht, mit der Möglichkeit, das Abflusssystem MULTI zu verwenden.

care



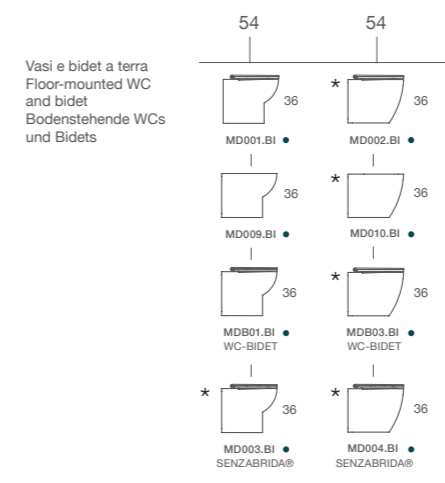
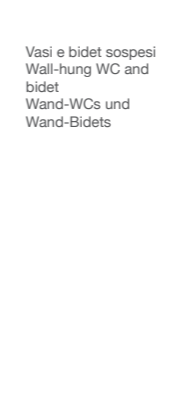
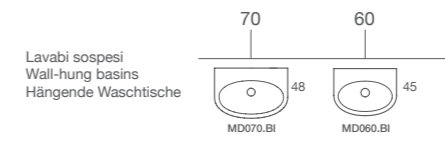
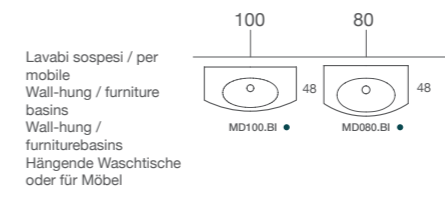

* Per la disponibilità degli articoli contrassegnati da (*) verrà fatta apposita comunicazione/
For the availability of the items marked with (*) will be made specific communication /
die Verfügbarkeit der durch (*) markierten Artikel wird durch eine Mitteilung bekanntgemacht.

• Articolo disponibile nelle colorazioni "Bagno di Colore"
Article is available in the colors "Bagno di Colore"
Dieser Artikel ist verfügbar in der Kollektion "Bagno di Colore"

▼
MD080.BI

Lavabo sospeso con base (MDMC80Y001)
finitura bianco ceramico
Wall-hung basin with cabinet (MDMC80Y001)
white ceramic finish
Wand-Waschtisch mit wandhängendem
Unterschrank (MDMC80Y001)
Keramik weiß lackiert
80.48

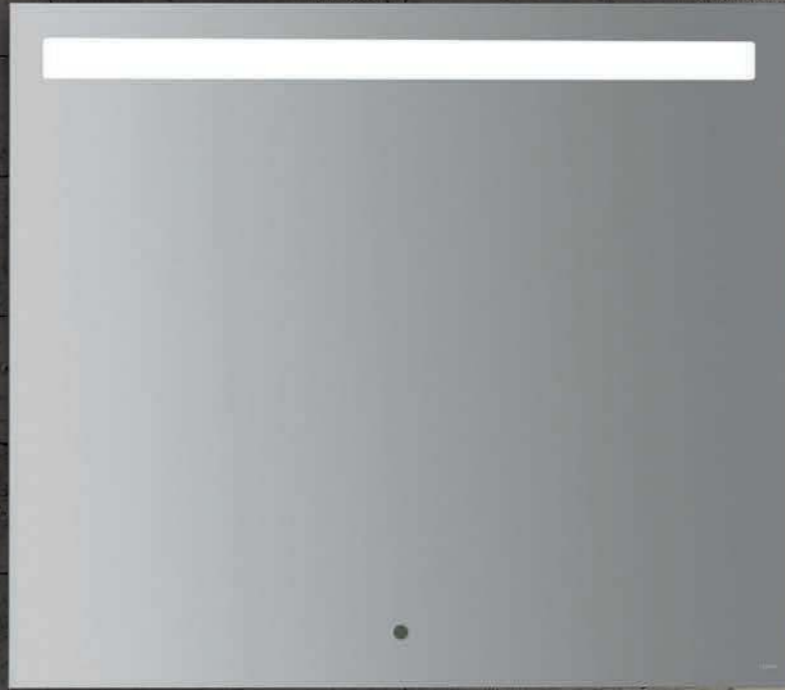

▼
MD002.BI - MD010.BI

Vaso e bidet a terra
Floor-mounted WC and bidet
Bodenstehende WC und Bidet
54.36

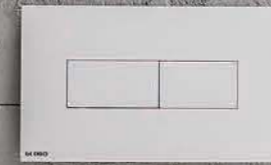



▼
MD002.BI - MD010.BI

Vaso e bidet a terra
Floor-mounted WC and bidet
Bodenstehende WC und Bidet
54.36



▼
MDS02.BI - MDS09.BI

Vaso e bidet sospesi
Wall-hung WC and bidet
Wand Wc und Wand bidet
54.36





▼
MD060.BI
Lavabo sospeso
Wall-hung basin
Wand-Waschtisch
60.45



▼
MD080.BI
Lavabo sospeso con base (MDMC80Y906) finitura
smoke
Wall-hung basin with cabinet (MDMC80Y906) smoke
finish
Wand-Waschtisch mit wandhängendem Unterschrank
(MDMC80Y906) smoke Finish
80.48



▼
MD001.BI - MD009.BI

Vaso e bidet a terra
Floor mounted wc and bidet
Bodenstehende WCs und Bidets
54.36



SENZABRIDA®

Maggiore igiene ed estetica pulita / Greater hygiene and clean aesthetics /
Bessere Hygiene und saubere Ästhetik



Facilità di pulizia /
Easy to clean /
Einfache Reinigung



Rumorosità ridotta /
Silent / Reduzierter
Lärm



Flusso acqua pilotato
/ Piloted water flow /
Gesteuerter
Wasserfluss



Vasca esteticamente
più pulita / More attrac-
tive design / Ästhetisch
saubereres WC

SENZABRIDA® concentra l'uscita dell'acqua in un unico punto nella parte posteriore del vaso eliminando il bordo continuo perimetrale con vantaggi per l'igiene e la pulizia. L'acqua esce silenziosa come un velo, con un flusso circolare verso il basso e con alti livelli di performance professionale: l'uso è ideale quindi tanto nel mondo domestico quanto per le forniture.

SENZABRIDA® toilet bowl focuses on water flowing out in a single point at the rear of the bowl, eliminating the continuous perimeter rim to guarantee maximum hygiene and cleanliness. The water comes out silently in a circular downward flow to cover the bowl, allowing to deliver professional-level performances. This makes them ideal for both domestic and supply purposes.

SENZABRIDA® konzentriert den Wasseraustritt in einem einzigen Punkt im hinteren Teil des WCs und beseitigt den kontinuierlichen umlaufenden Rand mit Vorteilen für die Hygiene und die Reinigung. Das Wasser tritt leise aus, wie ein Schleier, mit einem kreisförmigen Fluss nach unten und mit hohen Leistungsstufen: die Verwendung ist sowohl in der häuslichen Umgebung als auch für Anschlüsse in öffentlichen Bereichen ideal.



Classic

Ricerca dell'essenziale

A search for the essential - Die Suche nach dem Wesentlichen

L'elevato livello qualitativo raggiunto da Globo viene esplicitato con gli elementi della Collezione Classic. Il disegno di questi articoli è caratterizzato da una forma quadrangolare e dalla presenza di angoli a spigolo vivo.

Elementi plus presenti nella collezione Classic / Plus elements available in the Classic collection / Zusätzliche für die Kollektion Classic erhältliche Technologien



CERASLIDE®



BATAFORM®

Globo's first-rate quality is highlighted by the elements belonging to the Classic Collection. The drawing of these items is characterized by the peculiar quadrangular shape as well as the presence of sharp corners.

Das hohe von Globo erreichte Qualitätsniveau drückt sich in den Elementen der Kollektion Classic aus. Das Design dieser Artikel zeichnet sich durch eine viereckige Form und das Vorhandensein von scharfen Kanten aus.



SCQ90.BI
Lavabo sospeso
Wall-hung basin
Wand-Waschtisch
90.50



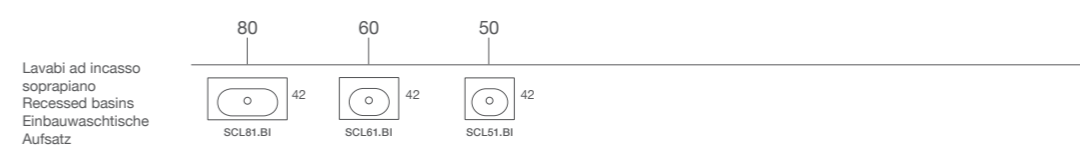
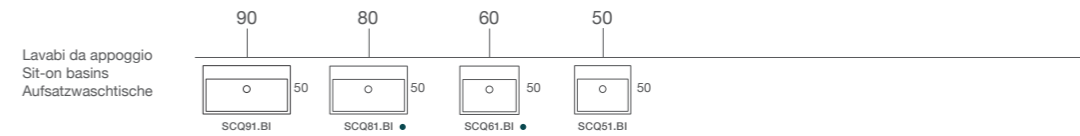
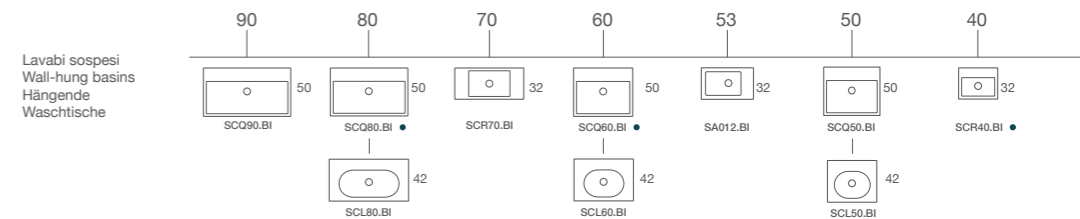

Si consiglia l'abbinamento con wc e bidet delle collezioni FORTY3 e STONE
 FORTY3 and STONE wc and bidet that can be combined with CLASSIC basins
 Wir empfehlen den Zusammenhang mit WC und Bidet der Kollektion FORTY3 und STONE

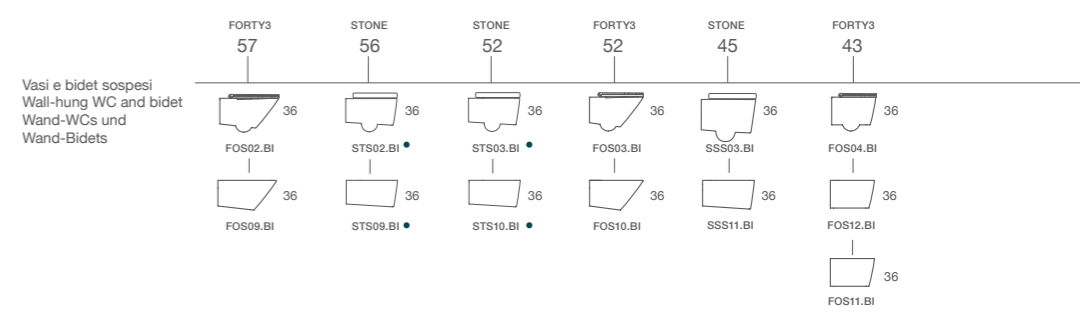

• Articolo disponibile nelle colorazioni "Bagno di Colore"
 Article is available in the colors "Bagno di Colore"
 Dieser Artikel ist verfügbar in der Kollektion "Bagno di Colore"



SCL80.BI

Lavabo sospeso
Wall-hung basin
Wand-Waschtisch

80.42





SCQ81.BI

Lavabo da appoggio

Sit-on basin

Aufsatzwaschtisch

80.50





SCQ80.PA

Lavabo sospeso colore PERLA

Wall-hung basin PERLA colour

Wand-Waschtisch Farbe PERLA

80.50



▼
SCQ51.BI

Lavabo da appoggio
Sit-on basin
Aufsatzwaschtisch
50.50



►
SCQ90.BI

Lavabo sospeso
Wall-hung basin
Wand-Waschtisch
90.50





▼
SCQ61.BI
Lavabo sospeso
Wall-hung basin
Wand-Waschtisch
60.50



▼
SA012.BI
Lavabo sospeso
Wall-hung basin
Wand-Waschtisch
53.32



▼
SCR40.BI
Lavabo sospeso
Wall-hung basin
Wand-Waschtisch
40.32



▼
SCQ51.BI
Lavabo da appoggio
Sit-on basin
Aufsatzwaschtisch
50.50



SCR40.BI
Lavabo sospeso
Wall-hung basin
Wand-Waschtisch
40.32



Genesis

Semplicemente fluido

Simply fluid - Einfach fließend

Genesis, like beginning and creation of everything. Organic and natural shapes, rounded and smooth, characterized by a feminine minimalist style. Genesis collection represents the synthesis of a wide full and functional project, characterized by many different elements thought and developed following the original stylistic course animating the entire series.

Genesis, als Anfang und Schöpfung aller Dinge. Organische und natürliche Formen, wie das Spiel zwischen abgerundeten Kanten und weichen Rundungen, um ein neues Design in minimalistischem Stil in Anlehnung an das Weibliche zu schaffen. Die Kollektion Genesis verkörpert die Synthese eines umfassenden Projekts, vollständig und funktional, das aus zahlreichen Elementen besteht, die alle unter Befolgung der originellen stilistischen Linienführung, die die gesamte Kollektion auszeichnet, erdacht und entworfen wurden.

Genesis, come principio e creazione di ogni cosa. Forme organiche e naturali, quale incontro di linee tra spigoli arrotondati e curve morbide, a creare un design nuovo, in stile minimalista declinato al femminile. La collezione Genesis rappresenta la sintesi di un progetto amplissimo, completo e funzionale, composto di tanti elementi, tutti pensati e disegnati seguendo l'originale percorso stilistico che caratterizza l'intera collezione.

Elementi plus presenti nella collezione Genesis / Plus elements available in the Genesis collection / Zusätzliche für die Kollektion Genesis erhältliche Technologien



CERASLIDE®



BATAFORM®



WC - bidet



FISSAGGIOGHOST®





Lavabi sospesi
Wall-hung basins
Hängende
Waschtische

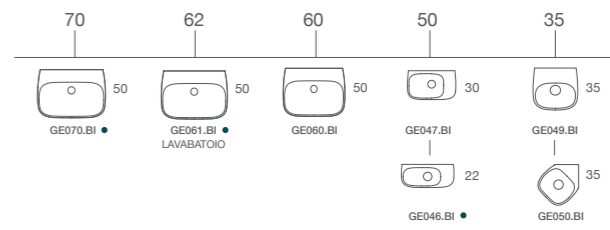

Lavabi da appoggio
Sit-on basins
Aufsatzwaschtische

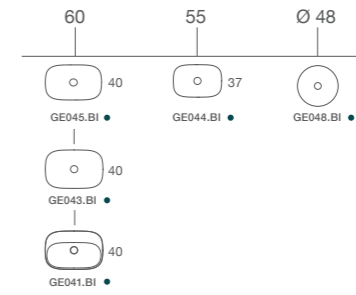

Lavabi ad incasso
soprapiano
Recessed basins
Einbauwaschtische
Aufsatz

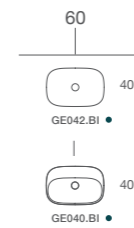

Lavabi ad incasso
sottopiano
Undertop basins
Einbauwaschtische
Untersatz

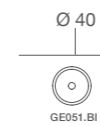

Vasi e bidet sospesi
Wall-hung WC and
bidet
Wand-WCs und
Wand-Bidets

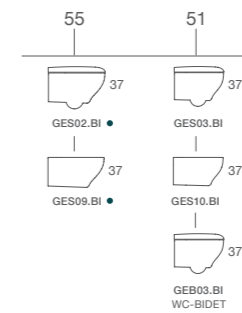

Vasi e bidet a terra
Floor-mounted WC
and bidet
Bodenstehende WCs
und Bidets

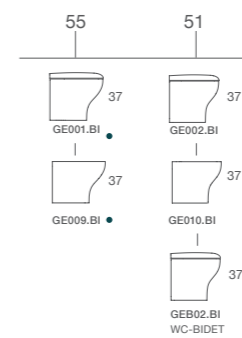

Vasi e bidet a terra
Floor-mounted WC
and bidet
WC-Kombination

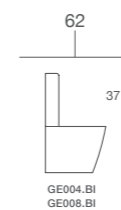

• Articolo disponibile nelle colorazioni "Bagno di Colore"
Article is available in the colors "Bagno di Colore"
Dieser Artikel ist verfügbar in der Kollektion "Bagno di Colore"



GE001.BI - GE009.BI

Vaso e bidet a terra

Floor mounted WC and bidet

Bodenstehende WCs und Bidets

55. 37



GE042.BI

Lavabo ad incasso soprapiano

Recessed basin

Einbauwaschtisch

60.40



GES03.BI - GES10.BI

Vaso e bidet sospesi
Wall-hung WC and bidet
Wand Wc und Wand bidet
51.37



GE046.BI
Lavabo sospeso
Wall-hung basin
Wand-Waschtisch
50.22



◀ **GE061.BI**
LAVABATOIO®
Lavabo sospeso
Wall-hung basin
Wand-Waschtisch
62.50



▶ **GE060.BI**
Lavabo sospeso
Wall-hung basin
Wand-Waschtisch
60.50

▼
GES02 .BI - GES09.BI
Vaso e bidet sospesi
Wall-hung WC and bidet
Wand Wc und Wand bidet
55.37



▲
GE048.BI
Lavabo da appoggio
Sit-on basin
Aufsatzwaschtisch
ø 48





▶
VAGEBI
Vasca
Bathtub
Badewannen
180,84



WC-bidet

Vaso e bibet a terra / Floor-mounted toilet and bidet / Bodenstehendes WC und Bidet

Vantaggi / Benefits / Vorteile



Funzione integrata di wc e bidet in un unico elemento / Toilet and bidet integrated in a single element / Integrierte Funktion eines WCs und Bidets in einem einzigen Element



Ideale per spazi ristretti, secondi bagni, ristrutturazioni / Ideal for small spaces, second bathrooms, renovations / Ideal für enge Räume, Zweitbäder, Sanierungen



Consente una corretta igiene personale / Allows proper personal hygiene / Ermöglicht eine korrekte Körperpflege



Garantisce un risparmio economico e di risorse ambientali / Guarantees savings in cost and space / Garantiert eine wirtschaftliche Einsparung und eine Einsparung von Umweltressourcen

Due funzioni, wc e bidet, in un unico prodotto. I vasi-bidet Globo nascono per unire esigenze differenti, utili in spazi ristretti per la loro duplice funzione, secondi bagni e ristrutturazioni. L'erogatore posto nella parte posteriore permette l'uso del sanitario come bidet consentendo notevole risparmio idrico ed economico.

Zwei Funktionen, WC und Bidet, in einem einzigen Produkt. Die WC-Bidets Globo sind entstanden, um unterschiedliche Bedürfnisse zu vereinen. Wegen ihrer Doppelfunktion sind sie in engen Räumen, Zweitbädern und Sanierungen nützlich. Der Verteiler im hinteren Teil ermöglicht die Verwendung der Sanitärkeramik als Bidet und ermöglicht erhebliche Wasser- und finanzielle Einsparungen.

Two functions, toilet and bidet, in one product. The Globo toilet-bidet was created to bring together different needs, perfect for small spaces due to their dual function, second bathrooms and renovations. The dispenser placed in the back allows using the bowl as a bidet, resulting in significant cost and water savings.



GE002.BI - GE010.BI

Vaso e bidet a terra
Floor Mounted WC and bidet
Bodenstehende WCs und Bidets
51.37



GE070.BI

Lavabo sospeso
Wall-hung basin
Wand-Waschtisch
70.50



GE001.BI - GE009.BI

Vaso e bidet a terra
Floor Mounted WC and bidet
Bodenstehende WCs und Bidets
55.37





Bowl

Sensualità formale

Formal sensuality - Formale Sinnlichkeit

Una Collezione che prende ispirazione dall'utilizzo di forme morbide e arrotondate; un disegno semplice e pulito che consente di arredare e impreziosire qualsiasi ambiente bagno. In particolare il disegno del sanitario sospeso rappresenta la rivisitazione minimal della classica forma "a uovo", per interpretare un sanitario con il fascino discreto della modernità. Sensualità formale e seduzione sottolineano il disegno di tutti gli articoli della Collezione Bowl.

Elementi plus presenti nella collezione Bowl/ Plus elements available in the Bowl collection / Zusätzliche für die Kollektion Bowl erhältliche Technologien



CERASLIDE®



BATAFORM®

A collection fully inspired by soft and rounded shapes; a simple, clean design able to furnish and embellish any bathroom. In the specific the design of the wall-hung sanitary represents the minimalist revisiting of the classical "egg" shape, interpreting a sanitary characterized by the quite appeal of modernity. Formal sensuality and seduction underline the design of all the items belonging to the Bowl collection.

Eine Kollektion, die durch die Verwendung von weichen und abgerundeten Formen inspiriert wird; ein einfaches und klares Design, das die Einrichtung und Verschönerung jedes Badzimmers ermöglicht. Insbesondere das Design der wandhängenden Sanitärkeramik stellt die Neuinterpretation der klassischen „Ei“-Form dar, um eine sanitäre Einrichtung mit dem diskreten Charme der Moderne zu interpretieren. Formale Sinnlichkeit und Verführung unterstreichen das Design aller Artikel, die Teil der Kollektion Bowl sind.





Lavabi sospesi
Wall-hung basins
Hängende
Waschtische

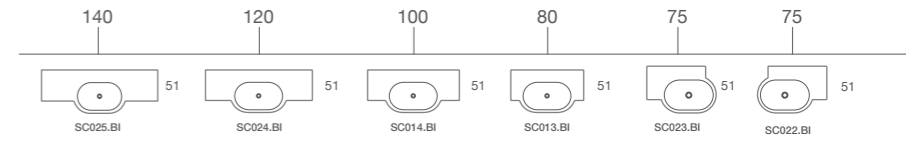

Lavabi sospesi
Wall-hung basins
Hängende
Waschtische

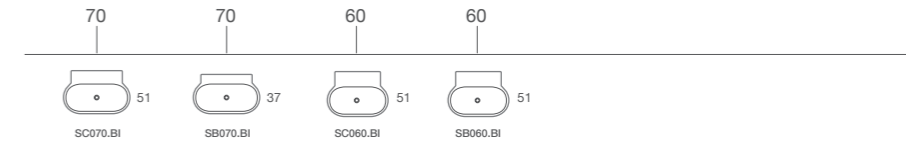

Lavabi da appoggio
Sit-on basins
Aufsatzwaschtische

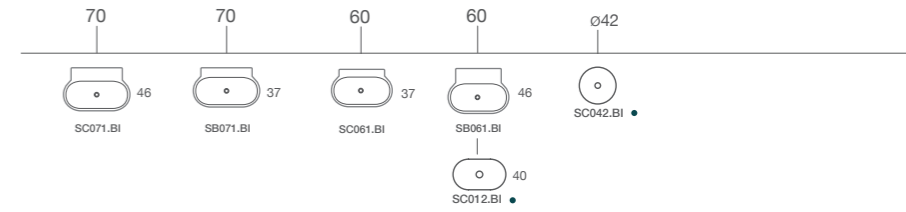

Vasi e bidet sospesi
Wall-hung WC and
bidet
Wand-WCs und
Wand-Bidets

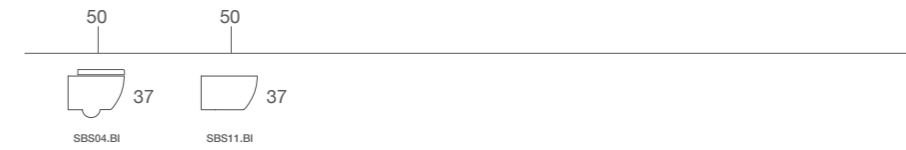

Vasi e bidet a terra
Floor-mounted WC
and bidet
Bodenstehende WCs
und Bidets





▲
SB070.BI
 Lavabo sospeso
 Wall-hung basin
 Wand-Waschtisch
70.37



▲
SC022.BI - SC023.BI
 Lavabo sospeso
 Wall-hung basin
 Wand-Waschtisch
75.51



◀
SC013.BI
Lavabo sospeso
Wall-hung basin
Wand-Waschtisch
80.51

▶
SBS04.BI - SBS11.BI
Vaso e bidet sospesi
Wall-hung WC and bidet
Wand Wc und wand bidet
50.37







▶
SC025.BI

Lavabo sospeso
Wall-hung basin
Wand-Waschtisch
140.51



▶
SC014.BI

Lavabo sospeso con struttura (SC047) finitura cromo
Wall-hung basin whit structure (SC047) chrome finish
Wand-Waschtisch mit wandhängendem Gestell (SC047) Verchromt
100.51



▶
SC061.BI
Lavabo da appoggio
Sit-on basin
Aufsatzwaschtisch
60.46



▼
SB002.BI - SB010.BI
Vaso e bidet a terra
Floor-mounted WC and bidet
Bodenstehende WCs und Bidets
50.37



▶
VABOCA
Vasca
Bathtub
Badewanne
185.85



Relais Armonia decò

Harmonious decor - Dekorative Harmonie

La collezione Relais esprime una visione dell'ambiente bagno contemporaneo, dove funzionalità ed estetica sono in perfetta armonia. Oggetti che mantengono forme di memoria, che citano il passato e al tempo stesso propongono un'interpretazione di design futuristico.

Elementi plus presenti nella collezione Relais / Plus elements available in the Relais collection / Zusätzliche für die Kollektion Relais erhältliche Technologien



CERASLIDE®



BATAFORM®



WC - bidet



FISSAGGIOGHOST®

The Relais Collection expresses a vision of the contemporary bathroom, where functionality and aesthetic are in perfect harmony. Objects preserve the shapes of memory, quoting the past and offering a space age design interpretation.

Die Kollektion Relais drückt eine moderne Sicht des Badezimmers aus, in dem Funktionalität und Ästhetik miteinander in perfekter Harmonie stehen. Objekte, die die Formen der Erinnerung, die die Vergangenheit zitieren, beibehalten und gleichzeitig eine futuristische Interpretation des Designs bieten.



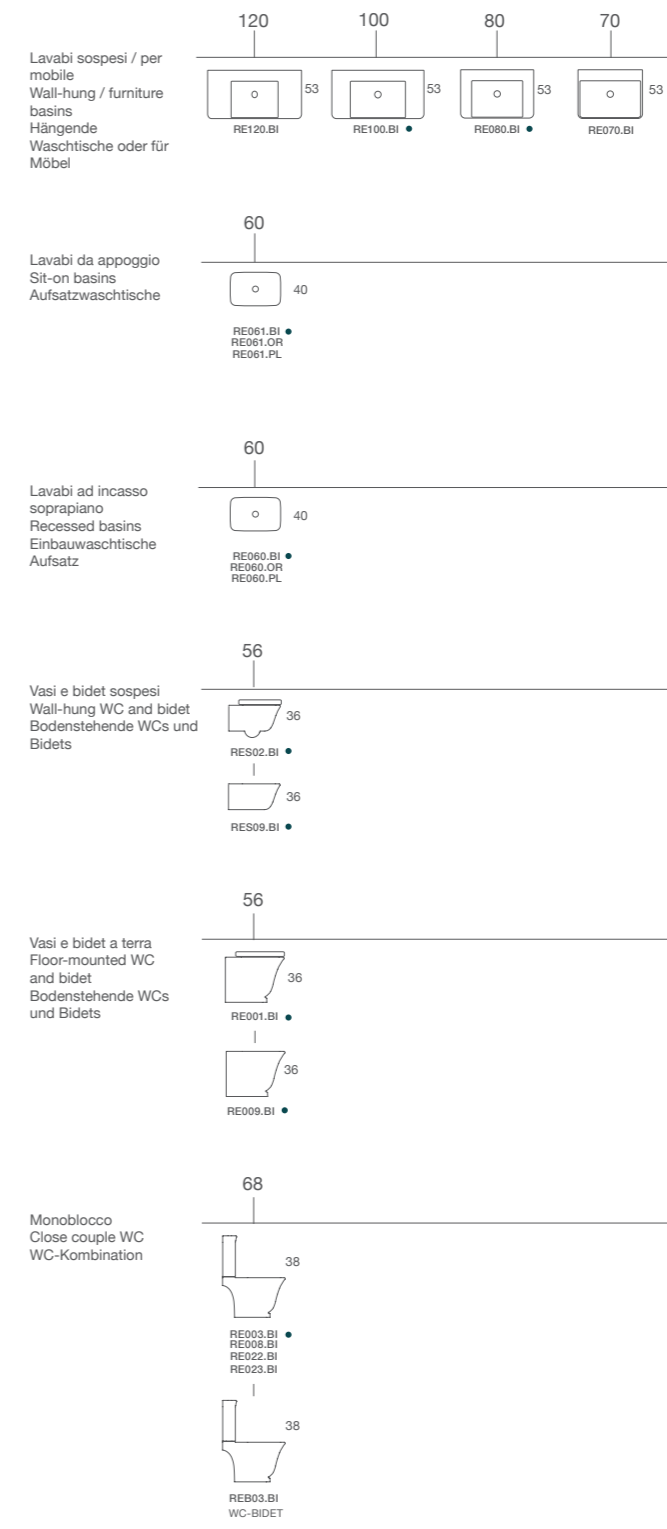

• Articolo disponibile nelle colorazioni "Bagno di Colore"
Article is available in the colors "Bagno di Colore"
Dieser Artikel ist verfügbar in der Kollektion "Bagno di Colore"



RE100.BI

Lavabo sospeso con base (MS100NC)
finitura nero lucido

Wall-hung basin whit base (MS100NC)
shiny black finish

Wand-Waschtisch mit wandhängendem
Unterschrank

(MS100NC) Glänzend schwarz

100.53

▼
RE003.BI

Vaso monoblocco con cassetta (RE008.BI)

Close couple WC whit cistern (RE008.BI)

WC-Kombination mit Spülkasten (RE008.BI)

63.36



▲
RE120.BI

Lavabo sospeso con struttura (ST120CR) finitura cromo

Wall-hung basin whit structure (ST120CR) chrome finish

Wand-Waschtisch mit bodenstehendem Gestell (ST120CR) Verchromt

120.53



▲
RE080.BI
 Lavabo sospeso
 Wall-hung basin
 Wand-Waschtisch
80.53



►
RE060.BI
 Lavabo ad incasso con consolle a terra (ST060NE) e gambe (GA060NE) finitura nero lucido
 Recessed basin with Floor mounted console (ST060NE) and legs (GA060NE) shiny black
 Einbauwaschtisch mit bodenstehendem Gestell (STO60NE) und Füßen (GA060NE) mit schwarz
 glänzenden Finishes.
60.40



▶ **RE060.OR**

Lavabo ad incasso con base (MS060BC) finitura bianco lucido
Recessed basin whit base (MS060BC) shiny white finish
Einbauwaschtisch mit wandhängendem Unterschrank (MS060BC) Glänzend schwarz
60.40





RE001.BI - RE009.BI

Vaso e bidet a terra

Floor-mounted WC and bidet

Bodenstehende WCs und Bidets

56.36



RE080.BI

Lavabo sospeso

Wall-hung basin

Wand-Waschtisch

80.53

▼
RE001.RU - RE009.RU

Vaso e bidet a terra colore RUGIADA
Floor-mounted WC and bidet RUGIADA colour
Bodenstehende WCs und Bidets RUGIADA Farbe
56.36



▼
RE100.RU

Lavabo sospeso colore RUGIADA
Wall-hung basin RUGIADA colour
Wand-Waschtisch RUGIADA Farbe
100.53





Paestum

Equilibrio sofisticato

Sophisticated equilibrium - Ausgeklügelte Balance

Paestum, un concetto di eleganza sussurrata e assolutamente chic, scandita nel tempo con continuità e sensibilità, frutto di un meticoloso equilibrio tra passato, con il recupero dei motivi classici, e l'attualità prossima. Il programma Paestum esce dagli schemi per definire un bagno lifestyle pieno di charme e rinnovata freschezza per conservare negli anni una perfetta coerenza di styling. Ricchezza di materiali, linee sofisticate e finiture ricercatissime permettono di realizzare una varietà di soluzioni per arredare la stanza da bagno dalle atmosfere rarefatte ed esclusive con protagonisti materiali preziosi e particolari.

Elementi plus presenti nella collezione Paestum / Plus elements available in the Paestum collection / Zusätzliche für die Kollektion Paestum erhältliche Technologien



CERASLIDE®



BATAFORM®



WC - bidet

Paestum, a concept of whispered elegance and absolutely chic, marked over time with continuity and sensitivity, final result of a meticulous balance between the past, recovering the classical motifs, and the very next future. The Paestum program breaks old patterns to define a lifestyle bathroom full of charm and renewed freshness, to maintain a perfect coherence of styling over the years. Richness of materials, sophisticated lines and sought finishes, allow the creation of a variety of solutions, furnishing the bathroom with a rarefied and exclusive atmosphere where precious and peculiar materials are the main characters.

Paestum, ein Konzept der gehauchten Eleganz und des absoluten Chics, im Laufe der Zeit durch Kontinuität und Sensibilität betont, Ergebnis eines akribischen Gleichgewichts zwischen der Vergangenheit mit Wiederbelebung klassischer Motive und der nahegelegenen Gegenwart. Das Programm Paestum geht neue Wege, um ein Lifestyle-Bad voller Charme und erneuerter Frische zu definieren, um im Laufe der Jahre eine perfekte Kohärenz des Stylings zu bewahren. Der Reichtum an Materialien, die anspruchsvollen Linien und die ausgesuchten Oberflächenbearbeitungen ermöglichen die Realisierung einer Vielzahl von Lösungen, um das Badezimmer mit einer exklusiven Atmosphäre mit kostbaren und besonderen Materialien einzurichten.





Lavabi sospesi /
per mobile
Wall-hung /
furniture basins
Waschtische oder für
Möbel

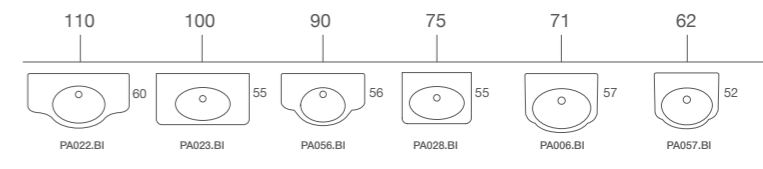

Lavabi ad incasso
Recessed basins
Einbauwaschtische
Untersatz

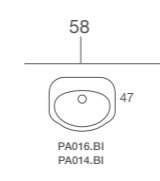

Vasi e bidet sospesi
Wall-hung WC and
bidet
Wand-WCs und
Wand-Bidets

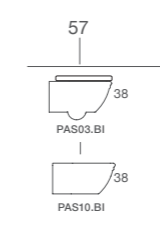

Vasi e bidet a terra
Floor-mounted WC
and bidet
Bodenstehende WCs
und Bidets

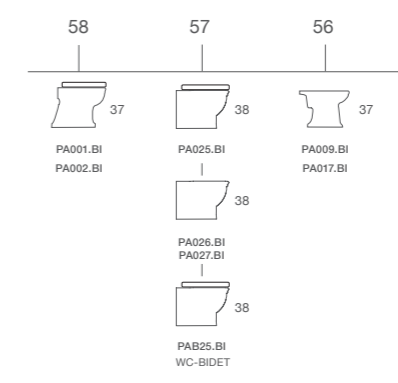

Monoblocco
Close couple WC
WC-Kombination

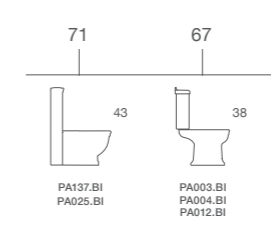



▼
PA057.BI

Lavabo sospeso con struttura (PA128)
finitura metallo anticato
Wall-hung basin whit structure (PA128)
old looking metal finish
Wand-Waschtisch mit wandhängendem
Gestell (PA128) antik-Metall Finishes
62.52

◀
PA001.BI - PA009.BI

Vaso e bidet a terra
Floor-mounted WC and bidet
Bodenstehende WCs und Bidets
56.37



▲
PA003.BI - PA009.BI

Vaso monoblocco e bidet a terra
Floor-mounted close couple WC and bidet
Bodenstehende WCs und Bidets
67.38 - 56.37



PA023.BI

Lavabo sopeso con base (PASL23)

finitura rovere moro

Wall-hung basin whit base (PASL23)

dark oak finish

Wand-Waschtisch mit wandhängendem

Unterschrank (PASL23)

Dunkle Eiche

100.55.h 54





PA001.BI - PA009.BI

Vaso e bidet a terra

Floor-mounted WC and bidet

Bodenstehende WCs und Bidets

56.37



PA057.BI

Lavabo sospeso con struttura (PA128)

finitura metallo antico

Wall-hung basin with structure (PA128)

old looking metal finish

Wand-Waschtisch mit wandhängendem

Gestell (PA128) antik-Metall Finish

62.52





▼
PA137.BI
Cassetta monolito per vaso PA025.BI
Monolite cistern for WC PA025.BI
Monolith Spülkasten für Wc PA025.BI
16.43. h 93



▼
PAS03.BI - PAS10.BI
Vaso e bidet sospesi
Wall-hung WC and bidet
Wand Wc und Wand bidet
57.38



►
PA056.BI
Lavabo con gambe in ceramica PA075.BI
Basin with ceramic legs PA075.BI
Wand-Waschtisch mit Fuß aus Keramik PA075.BI
90.56



PA022.BI

Lavabo sospeso
Wall-hung basin
Wand-Waschtisch
110.60



PA025.BI - PA027.BI

Vaso e bidet a terra
Floor mounted WC and bidet
Bodenstehende WC und Bidet
57.38





PAS03.BI - PAS10.BI

Vaso e bidet sospesi
Wall-hung WC and bidet
Wand Wc und Wand Bidet
57.38



PA056.BI

Lavabo sospeso
Wall-hung basin
Wand-Waschtisch
90.56



Daily

Comfort ogni giorno

Everyday comfort - Täglicher Komfort



Centro dei rituali del benessere e cura del corpo, il bagno è il luogo dove iniziano e finiscono le nostre giornate. La linea Daily si ispira proprio a questi momenti quotidiani dove non viene lasciato niente al caso e questi lavabi, sanitari ed accessori fanno in modo di accompagnarci allo stesso tempo con funzionalità e bellezza nella nostra vita. Una linea dalle forme morbide e allo stesso tempo decise rende piacevole il loro utilizzo e ogni nostro gesto.

Elementi plus presenti nella collezione Daily / Plus elements available in the Daily collection / Zusätzliche für die Kollektion Daily erhältliche Technologien



Bathroom is where our days begin and finish, the perfect place for our well-being and body care. Daily collection is inspired by these everyday moments where anything is left to chance and its pans, sanitary ware and accessories guide our life with functionality and beauty. This collection is characterized by soft and decisive shapes which make their use and every our action even more pleasant.

Als Zentrum der Wellnessrituale und der Körperpflege ist das Bad der Ort, an dem unsere Tage beginnen und enden. Die Linie Daily wird genau durch diese täglichen Momente inspiriert, wo nichts dem Zufall überlassen wird und diese Waschbecken, Sanitärkeramiken und Zubehörteile tragen gleichzeitig dazu bei, dass sie uns mit Funktionalität und Schönheit durch unser Leben begleiten. Eine Linie, die mit ihren weichen und gleichzeitig klaren Linien ihre Verwendung und all unsere Gesten angenehm macht.





Lavabi sospesi /
per mobile
Wall-hung /
furniture basins
Hängende
Waschtische oder für
Möbel

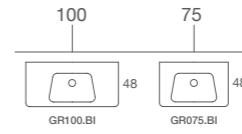

Lavabi sospesi
Wall-hung basins
Hängende
Waschtische

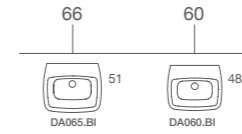

Vasi e bidet sospesi
Wall-hung WC and
bidet
Wand-WCs und
Wand-Bidets



Vasi e bidet a terra
Floor-mounted WC
and bidet
Bodenstehende WCs
und Bidets

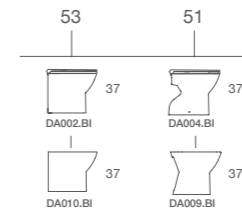

Monoblocco
Close couple WC
WC-Kombination

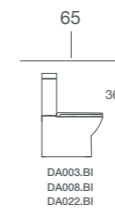

▼
DA002.BI - DA010.BI

Vaso e bidet a terra
Floor-mounted WC and bidet
Bodenstehende WC und Bidet
53.37

►
DA065.BI

Lavabo con colonna a terra LE005.BI
Basin with floor mounted pedestal LE005.BI
Wand-Waschtisch mit Standsäule LE005.BI
66.51



◀ **DAS02.BI - DAS09.BI**

Vaso e bidet sospesi
Wall-hung WC and bidet
Wand Wc und Wand Bidet
53.37





GR100.BI

Lavabo sospeso con base (DAM1Y093) finitura cenere opaco

Wall-hung basin whit base (DAM1Y093) cenere opaco finish

Wand-Waschtisch mit wandhängendem Unterschrank (DAM1Y093) cenere opaco Finishes

100.48

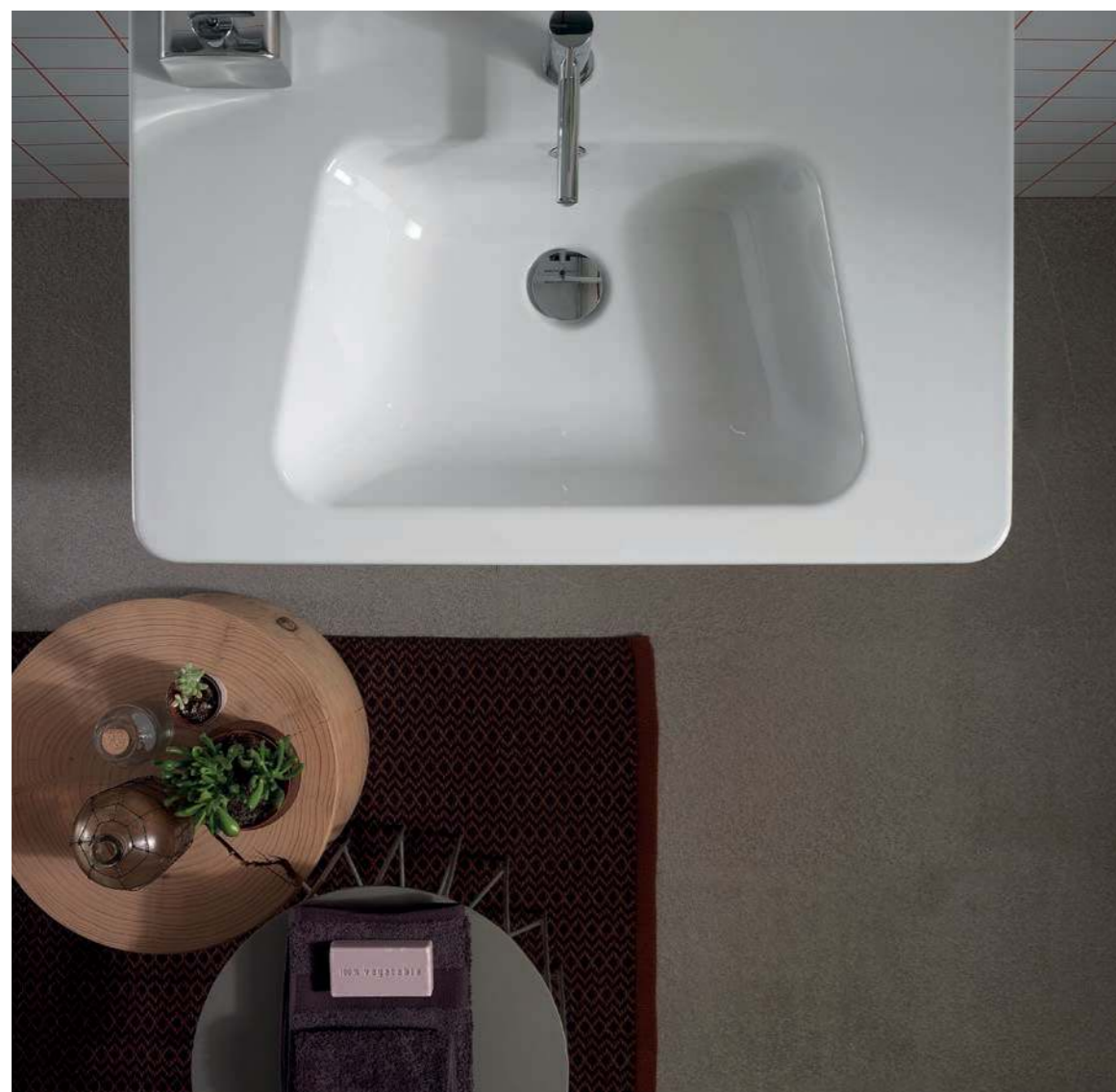

▲
GR075.BI
 Lavabo sospeso
 Wall-hung basin
 Wand-Waschtisch
75.48



▼
DA004.BI - DA009.BI
 Vaso e bidet a terra
 Floor-mounted WC and bidet
 Bodenstehende WC und Bidet
51.37



Grace

Eleganza morbida

Soft elegance - Weiche Eleganz

Grace, come la grazia e l'eleganza che pervade ogni elemento di questa Collezione. La morbidezza delle linee e un design contemporaneo che riporta a forme naturali viene esaltata in tutti gli articoli che la compongono. Una collezione, ideale sia per ambienti da bagno grandi che piccoli, per momenti di relax da vivere in città o in campagna a contatto con la natura.

Grace, like the elegance characterizing every single element of this new collection. The softness of the lines and a contemporary design, reminding natural shapes, is pointed out by all the items. A new series, ideal for both big and small bathrooms, to live the moment of relax in the city or in the country in close contact with nature.

Grace, wie die Anmut und Eleganz, die jedes Element dieser Kollektion durchdringt. Die Weichheit der Linien und ein modernes Design, die die natürlichen Formen aufzeigen, werden in allen Artikeln, die die Kollektion zusammensetzen, hervorgehoben. Eine neue Kollektion, sowohl für große als auch kleine Badezimmer, die für Momente der Entspannung in der Stadt oder auf dem Land in direktem Kontakt mit der Natur ideal ist.





Lavabi sospesi /
per mobile
Wall-hung /
furniture basins
Hängende
Waschtische oder für
Möbel

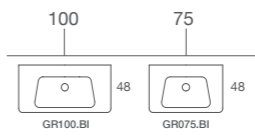

Lavabi sospesi
Wall-hung basins
Hängende Waschtische

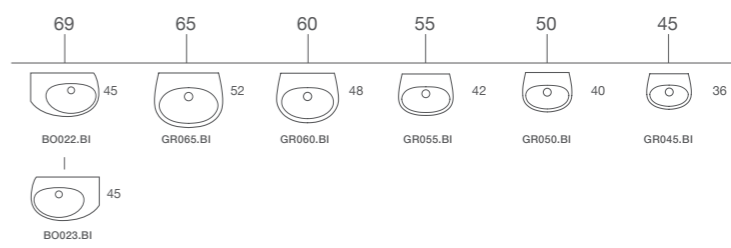

Lavabi semincasso
Semi-recessed basins
Halbeinbauwasch-
tische

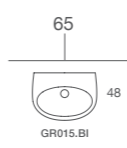

Vasi e bidet sospesi
Wall-hung WC and
bidet
Wand-WCs und
Wand-Bidets

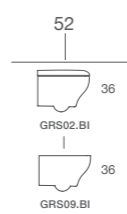

Vasi e bidet a terra
Floor-mounted WC
and bidet
Bodenstehende WCs
und Bidets

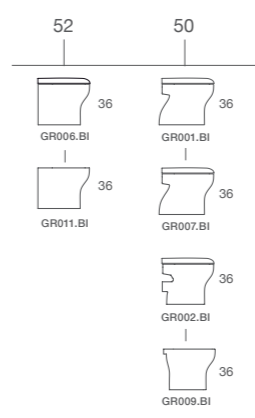

Monoblocco
Close couple WC
WC-Kombination

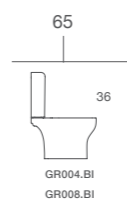

▶ **GR065.BI**

Lavabo sospeso
Wall-hung basin
Wand-Waschtisch
65.52

▼ **GR006.BI - GR011.BI**

Vaso e bidet a terra
Floor mounted Wc and bidet
Bodenstehende WC und Bidet
52.36





◀
GR006.BI - GR011.BI
 Vaso e bidet a terra
 Floor mounted wc and bidet
 Bodenstehende WCs und Bidets
52.36



▲
GRS02.BI - GRS09.BI
 Vaso e bidet sospesi
 Wall-hung WC and bidet
 Wand-WC und Wand-Bidet
52.36



▲
GR065.BI
Lavabo sospeso
Wall-hung lavabo
Wand-Waschtisch
65.52



▲
GR004.BI
Vaso monoblocco con cassetta (GR008.BI)
Close couple WC whit cistern (GR008.BI)
WC-Kombination mit Spülkasten (GR008.BI)
65.36



New Arianna Cura naturale

Natural care - Natürliche Pflege

La linea Arianna, rinnovata in alcuni suoi prodotti, come i nuovi lavabi e i nuovi sanitari a terra, continua la sua evoluzione, sempre fedele alle sue forme pulite, che non lasciano spazio al superfluo. Questa semplicità formale permette a questo prodotto di essere durevole nel tempo e sempre contemporaneo.

Some of the products of the Arianna line have been renewed, such as the washbasins and floor-mounted sanitary fixtures, continuing its evolution and staying faithful to basic, no-frills shapes. This formal simplicity makes these products long-lasting and contemporary.

Die Linie Arianna, in einigen ihrer Produkte überarbeitet, wie die neuen Waschbecken und die neuen bodenstehenden Sanitärkeramiken, hält ihre klaren Formen, die dem Überflüssigen keinen Platz einräumen, weiterhin die Treue. Diese formale Einfachheit erlaubt diesem Produkt über die Zeit zu dauern und stets modern zu sein.

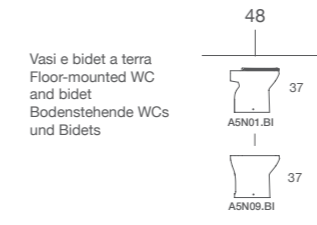
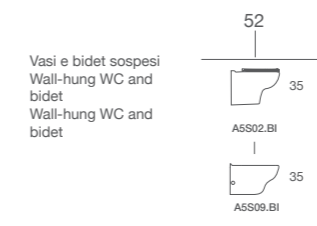
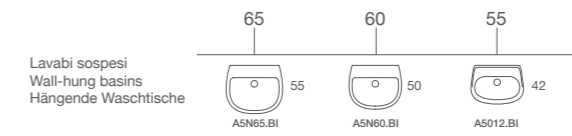



A5S02.BI - A5S09.BI

Vaso e bidet sospesi
Wall-hung WC and bidet
Wand Wc und Wand Bidet
52.35



A5N01.BI - A5N09.BI

Vaso e bidet a terra
Floor mounted WC. and bidet
Bodenstehende WC und Bidet
48.37





A5N60.BI

Lavabo con colonna a terra LE005.BI
Basin with floor mounted pedestal LE005.BI
Wand-Waschtisch mit Standsäule LE005.BI
60.50

Le Pietre

Il piacere della materia

The pleasure of matter - Die Freude an der Sache



Ricerca e innovazione sono alla base degli sviluppi di una gamma di prodotti in continua evoluzione, ben articolata per offrire soluzioni estetiche e funzionali che rispondano alle esigenze di una clientela ampia e diversificata. Le finiture Peperino e Travertino, le classiche pietre del territorio viterbese eleganti e discrete, sono l'elemento distintivo della collezione Le Pietre.

Research and innovation are at the bottom of a range of ever-changing products, a well-articulated series offering aesthetical and functional solutions, meeting the needs of a wide customer base. Peperino and Travertine, the typical stones belonging to our peculiar geographical area, elegant and quite, represent the main element characterizing Le Pietre Collection.

Forschung und Innovation sind die Grundlage der Entwicklungen einer Produktpalette in kontinuierlicher Entwicklung, gut artikuliert, um ästhetische und funktionale Lösungen anzubieten, die den Bedürfnissen eines großen und breitgefächerten Kundenstamms entsprechen. Travertin und Peperin, die klassischen Steine aus der Gegend um Viterbo, elegant und zurückhaltend, sind markante Elemente der Kollektion Le Pietre.

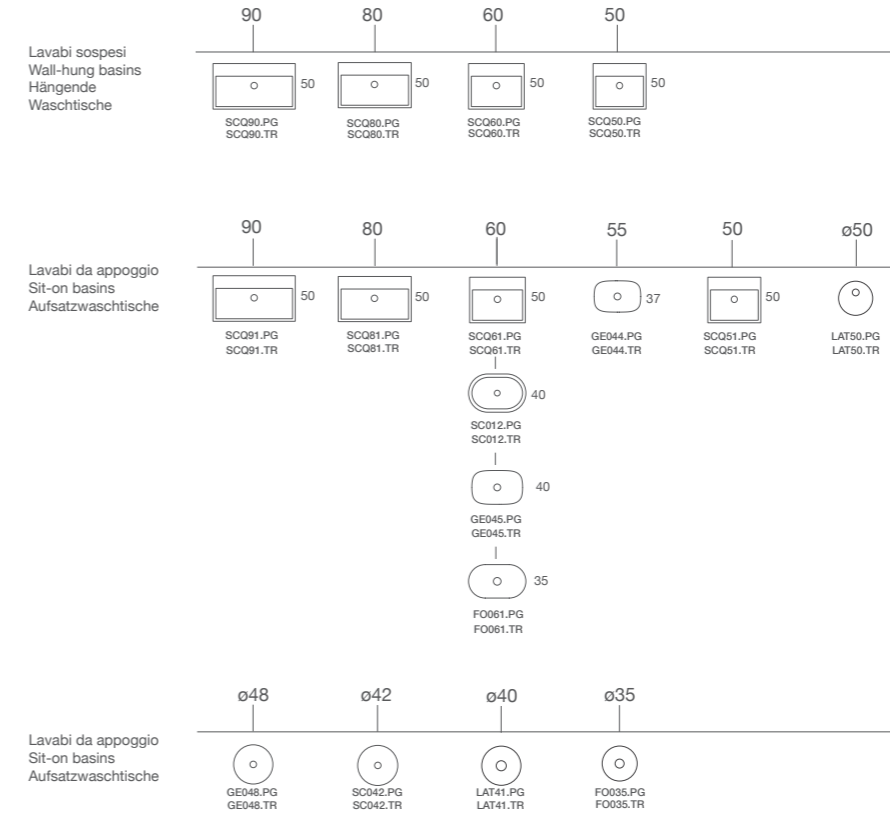



SCQ90.TR
Lavabo sospeso
Wall-hung basin
Wand-Waschtisch
90.50

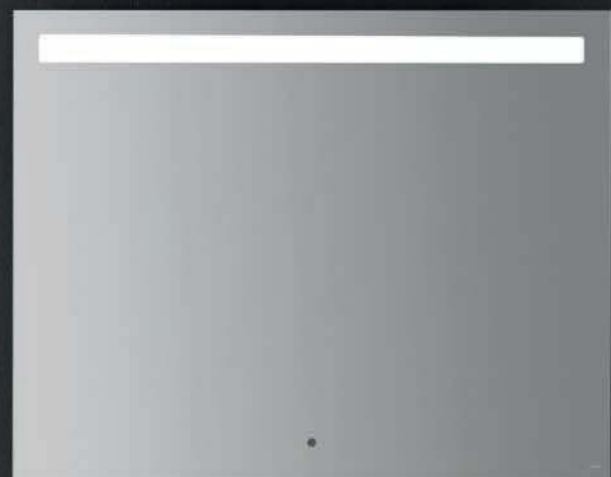

SC042.PG
Lavabo da appoggio
Sit-on basin
Aufsatzwaschtisch
Ø42





LAT50.PG

Lavabo da appoggio
Sit-on basin
Aufsatzwaschtisch
Ø50



SC012.TR

Lavabo da appoggio
Sit-on basin
Aufsatzwaschtisch
60.40



Docciardesia

Sensualità naturale

Natural sensuality - Natürliche Sinnlichkeit

Docciardesia è la Collezione di piatti doccia ad altezza ridotta, realizzati in Mineralmarble® (materiale antiscivolo e antimacchia ricavato da polvere di marmo unita a speciali resine), in finitura ardesia. L'ampissima gamma di dimensioni e colori offerti, oltre alla possibilità di realizzazione di piatti doccia anche su misura, consentono il suo utilizzo in bagni di piccoli o grandi dimensioni. Docciardesia è resistente all'usura ed alle abrasioni e grazie alla superficie rugosa risulta completamente antiscivolo.

Elementi plus nella collezione Docciardesia / Plus elements available in the Docciardesia collection / Zusätzliche für Docciardesia erhältliche Technologien



Taglio lineare o diagonale su richiesta / Linear or diagonal design on request / Gerader oder diagonaler Zuschnitt auf Anfrage



Bordo su misura / Custom-made edge / Kante nach Maß

Is the new collection of shower tray with a reduced height, composed by Mineralmarble® (An anti slip and anti spot material obtained from marble dust mixed with special resins) with a matt- black finishing. Thanks to the wide range of dimensions and colors is possible to use every shower tray in all kind of bathroom and this gives the possibility to create customized products. Docciardesia is ware and abrasion resistant and it is also completely anti-slip thanks to its rough surface. Moreover it is water-proof , vapor-proof and spot-proof.

Docciardesia ist die Kollektion von Duschwannen mit reduzierter Höhe, die aus Mineralmarble® (Antirutsch- und Antifleckenmaterial aus Marmorpulver in Verbindung mit speziellen Harzen) hergestellt wurde, in Schiefer-Endbearbeitung. Die umfassende Palette an angebotenen Maßen und Farben und die Möglichkeit, die Duschwannen auch nach Maß herzustellen, ermöglichen ihre Anwendung in kleinen und in großen Bädern. Docciardesia ist beständig gegen Verschleiß und Abrieb und dank der rauen Oberfläche ist sie vollständig rutschfest.

Docciardesia

Piatto doccia / Shower tray / Duschwanne

Vantaggi / Benefits / Vorteile



Taglio lineare o diagonale su richiesta / Linear or diagonal design on request / Gerader oder diagonaler Zuschnitt auf Anfrage

Il piatto Docciardesia offre l'opportunità di adattarsi alle dimensioni del Vs. bagno. I tagli a misura possono essere richiesti al momento dell'ordine oppure possono essere effettuati direttamente al momento della loro posa in opera: può essere tagliato linearmente in lunghezza, larghezza e diagonale. Possono inoltre essere fatti anche tagli speciali per la presenza di eventuali pilastri. Per il taglio è necessario l'uso di dischi diamantati a secco o a umido.

Docciardesia shower trays perfectly match with the dimension of your bathroom. Custom cuts can be requested when order is placed or can be made directly when the shower trays are installed; The shower tray can be cut linearly in length, width and diagonal. Moreover, is possible to make further cuts to insert possible pillars. In order to make the cuts, dry or wet diamonds blades must be used.

Die Duschwanne Docciardesia bietet die Möglichkeit, sich den Abmessungen Ihres Bades anzupassen. Die maßgeschneiderten Zuschnitte können zum Zeitpunkt der Bestellung erfragt oder direkt zum Zeitpunkt ihrer Verlegung durchgeführt werden: es kann gerade in der Länge, Breite und diagonal zugeschnitten werden. Zudem können auch spezielle Zuschnitte für das Vorhandensein etwaiger Säulen ausgeführt werden. Für den Zuschnitt ist die Verwendung von Trocken- oder Feuchtdiamantenscheiben erforderlich.



Piatti doccia
Shower trays
Duschwannen

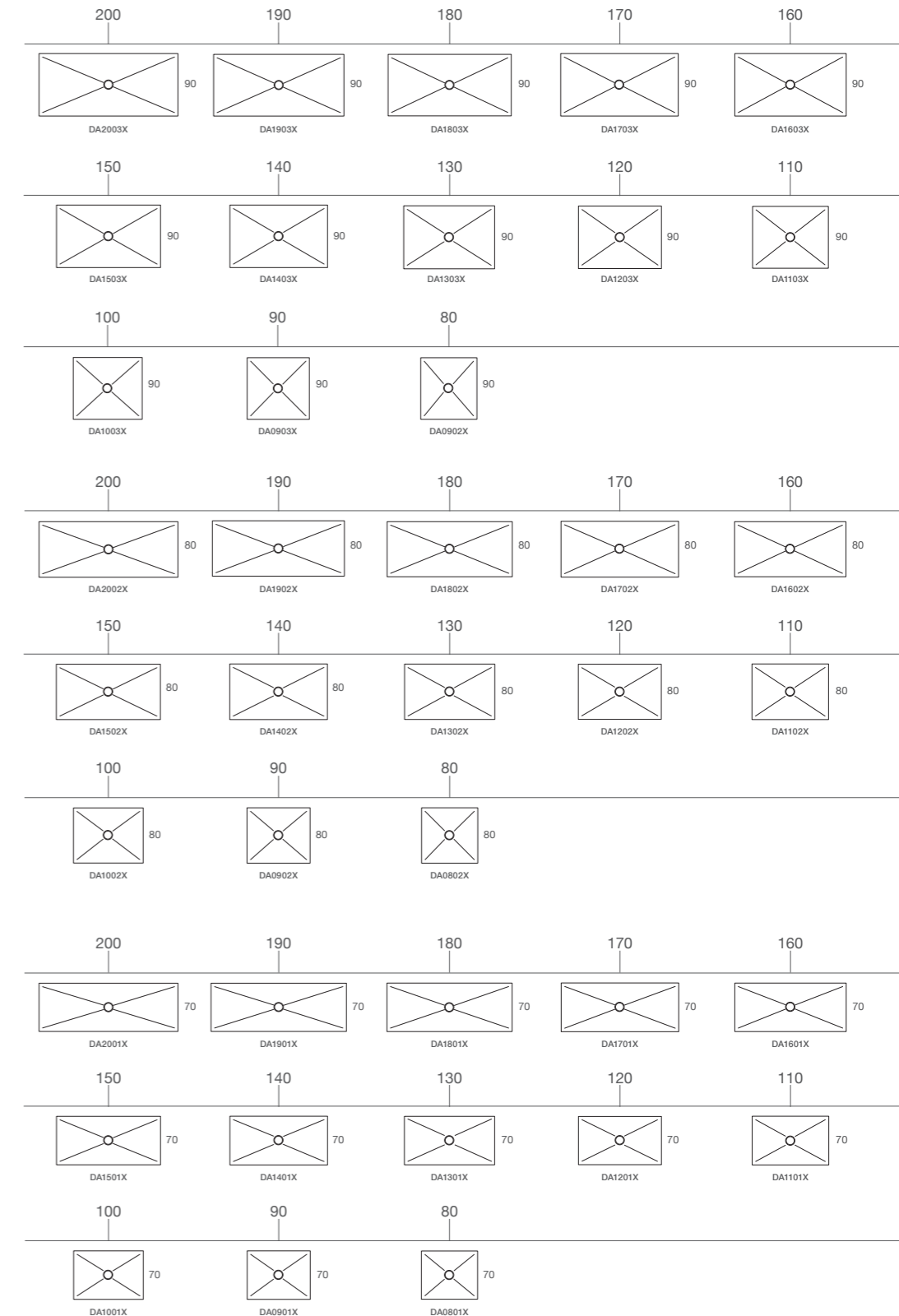



Bordo su misura / Custom-made edge /
Kante nach Maß

Docciardesia può essere fornito corredato di bordo contenitivo realizzato nello stesso materiale del piatto.

Docciardesia can be provided with restraining edges made with the same materials of the shower tray.

Docciardesia kann zusammen mit einer stützenden Kante, die aus demselben Material wie die Duschwanne gefertigt wird, geliefert werden.



Kit di riparazione / Repair kit /
Reparatur-Set

Il Kit di riparazione comprende tutto il necessario per il ripristino di eventuali scalfitture provocate accidentalmente sulla superficie del Docciardesia. E' necessario passare la carta abrasiva sulla parte da trattare, strofinare con cotone imbevuto del solvente, pulire a fondo la superficie ed infine ritoccare con il pennellino del ritocco. Lasciar asciugare prima di utilizzare il piatto doccia. Per la pulizia dopo la posa e per la pulizia ordinaria è necessario l'utilizzo di prodotti neutri.

The repair kit includes everything you need to restore any accidental scratches caused on Docciardesia surface. It is necessary to use the sandpaper on the interested part, wrinkle with cotton soaked in solvent, thoroughly clean the surface and then touch up with the brush of retouching. Let the shower tray dry before using it. To clean after the installation and for routine cleaning must be used neutral product.

Das Reparatur-Set enthält alles Notwendige für möglicherweise versehentlich auf der Oberfläche von Docciardesia verursachte Kratzer. Es ist erforderlich, mit dem Schleifpapier über die zu behandelnde Fläche zu gehen, mit Lösungsmittel getränkter Baumwolle abzureiben, die Oberfläche gründlich zu reinigen und schließlich mit dem Ausbesserungspinsel nachzubessern. Lassen Sie vor der Verwendung die Duschwanne trocknen. Für die Reinigung nach der Verlegung und die gewöhnliche Reinigung ist die Verwendung von neutralen Produkten erforderlich.



Kit di pulizia / Cleaning set /
Reinigungsset

Detergente per la pulizia degli articoli in ceramica
e piatti doccia DOCCIARDESIA

Cleaning detergent for ceramic products and
shower trays DOCCIARDESIA

Reinigungsmittel für Keramikartikel und
Duschwannen DOCCIARDESIA



Colori
Colours
Farben



Bianco
501



Beige
503

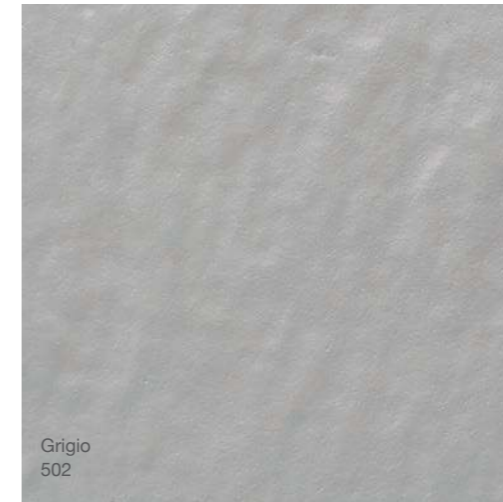

Grigio
502



Tortora
505

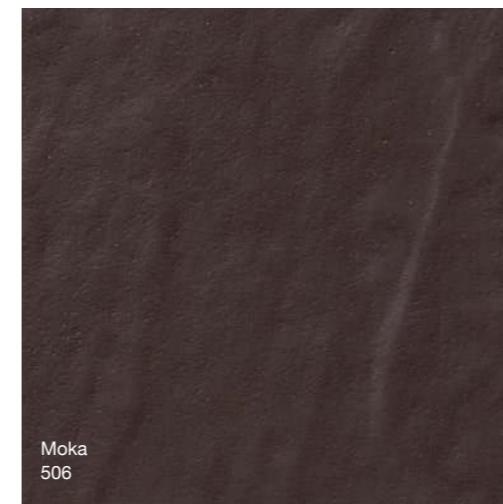

Moka
506

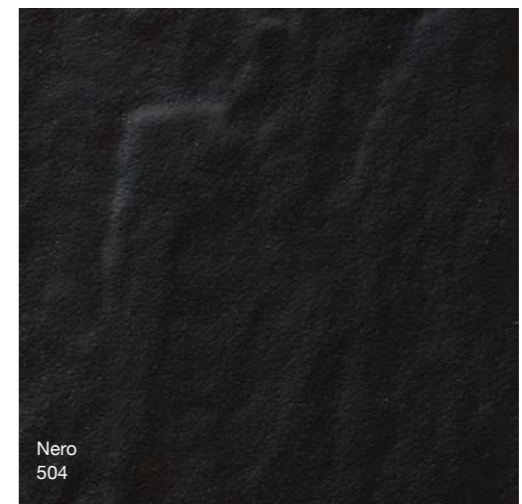

Nero
504



▶
DA1702X505
Piatto doccia colore TORTORA
Shower tray TORTORA finish
Duschwanne TORTORA Finishes
80.170

Docciaviva Piacere Tattile

Tactile pleasure - Die Freude am Berühren

Docciaviva è la proposta di piatti doccia in ceramica con altezza 6,5 cm. caratterizzata da un particolare e nuovo disegno avente funzione sia di antiscivolo che di massaggio plantare. Oltre che nel bianco lucido, Docciaviva è disponibile nei colorazioni ceramiche " Bagno di colore "

Elementi plus nella collezione Docciaviva / Plus elements available in the Docciaviva collection / Zusätzliche für die Kollektion Docciaviva erhältliche Technologien
Docciaviva



CERASLIDE®



BATAFORM®



Superficie antiscivolo / Non-slip surface / Anti-rutsch Oberfläche



Installazione da appoggio o filo pavimento / Sit-on or floor-mounted installation / Installation als Aufsatz-oder bodeninstallation

Docciaviva is the range of ceramic shower trays with a height of 6.5 cm and a special, new design with a non-slip and foot-massage function. In addition to glossy white, Docciaviva also comes in matte white and matte black.

Docciaviva ist der neue Vorschlag an Duschwannen aus Keramik mit einer Höhe von 6,5 cm, der sich durch ein besonderes und neues Design auszeichnet, das sowohl die Antirutsch-Funktion als auch die Funktion der Fußmassage hat. Außer in glänzend Weiß ist Docciaviva auch in den Farben matt Weiß und matt Schwarz erhältlich.



Piatti doccia
Shower trays
Duschwannen

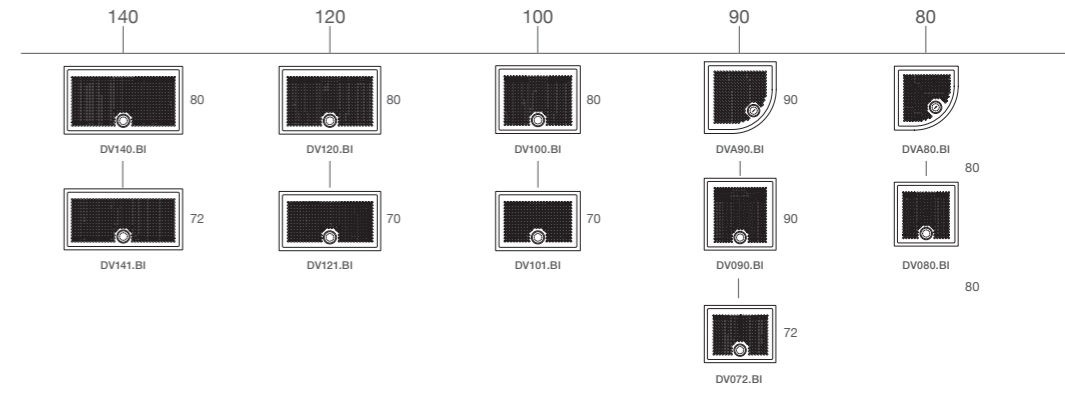

Docciaviva

Piatto doccia / Shower tray / Duschwanne

Vantaggi / Benefits / Vorteile



Superficie antiscivolo / Non-slip surface / Rutschfeste Oberfläche

Il particolare e innovativo disegno del piano interno del Docciaviva oltre alla funzione di antiscivolo fa godere anche di un benefico ed efficace massaggio plantare.

The particular and innovative design of the internal part of Docciaviva, In addition to the ant-slip function, ensures a beneficial and effective plantar massage.

Das besondere und innovative Design der internen Fläche von Docciaviva gewährleistet neben den Anti-rutsch-Funktionen auch eine wohltuende und wirksame Fußmassage.



Installazione da appoggio o filo pavimento / Sit-on or floor-mounted installation / Installation als Aufsatz oder bodenbündig

Grazie al loro ridotto spessore, i Piatti Docciaviva possono essere installati sia in appoggio che a filo pavimento. In abbinamento può essere utilizzata la piletta di scarico Cod. DS008 o qualsiasi altra piletta Ø 9 cm.

Thanks to their reduce thickness Docciaviva shower tray can be installed both in the sit on and in the back to floor version. Can be also used the drain code DS008 or any other drain (Ø 9 cm).

Dank ihrer reduzierten Stärke können die Duschwannen Docciaviva sowohl als Aufsatz als auch bodenbündig installiert werden. In Kombination kann der Abfluss Cod. DS008 oder jeder andere Abfluss mit Ø 9 cm verwendet werden.



▼
DV140.AT

Piatto doccia colore AGATA
Shower tray AGATA finish
Duschwanne AGATA Finishes

140.80

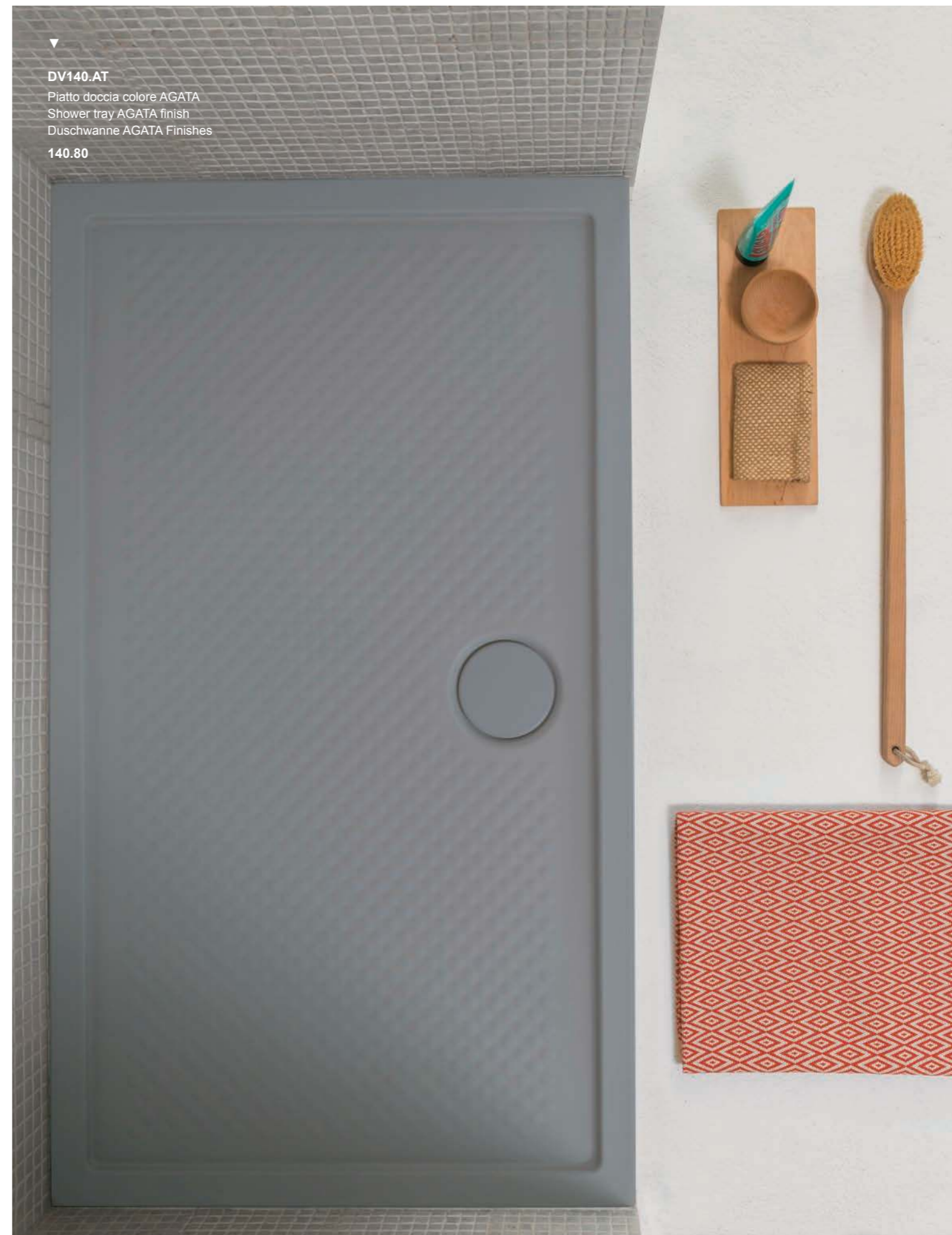

Docciabella

Piacere materico

Tactile pleasure - Die Freude am Material

La Collezione Docciabella propone una gamma di piatti doccia ad altezza ridotta, adatti ad essere installati sia a filo che sopra pavimento, provvisti di una esclusiva texture antiscivolo che ne esalta il disegno minimal.

Elementi plus nella collezione Docciabella / Plus elements available in the Docciabella collection / Zusätzliche für Docciabella erhältliche Technologien



CERASLIDE®



BATAFORM®

The Docciabella collection offers a range of slimline shower trays, suitable for mounting flush to the floor or on top of an existing floor. It has an exclusive non-slip texture that enhances the minimal design.

Die Kollektion Docciabella bietet eine Reihe von Duschwannen mit reduzierter Höhe, die geeignet sind, um bodenbündig oder oberhalb des Bodens installiert zu werden. Sie sind mit einer exklusiven Antirutsch-Textur, die das minimalistische Design hervorhebt, ausgestattet.



Piatti doccia
Shower trays
Duschwannen

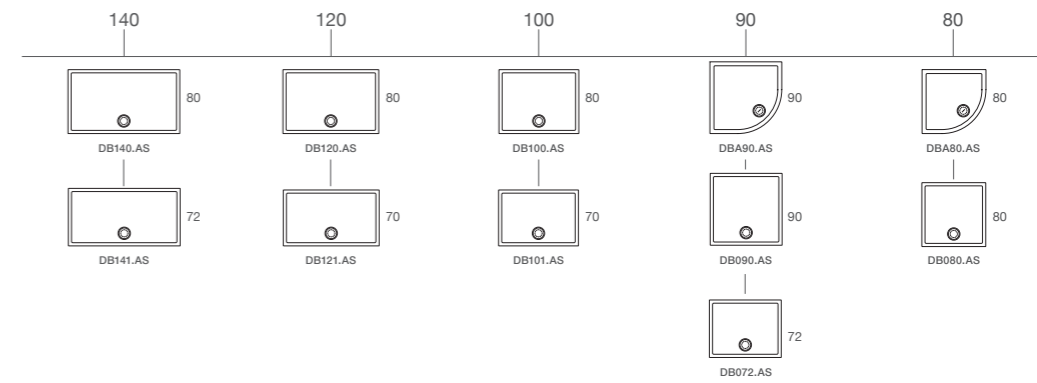

Piatti doccia tradizionali

Traditional Shower trays
Traditionelle Duschwannen



logo

Piatti doccia
Shower trays
Duschwannen

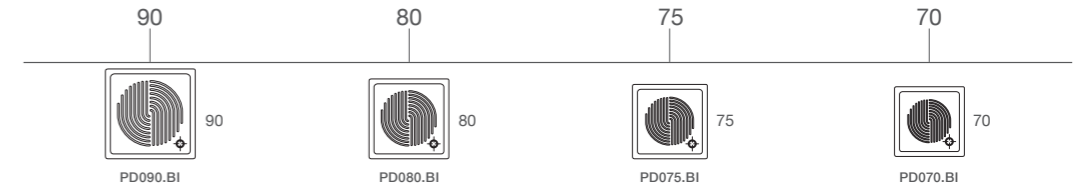

rettango

Piatti doccia
Shower trays
Duschwannen

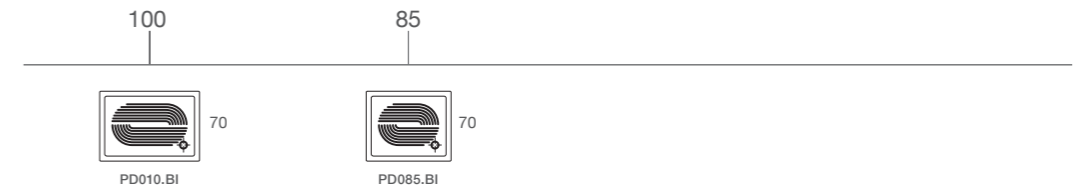

plano

Piatti doccia
Shower trays
Duschwannen

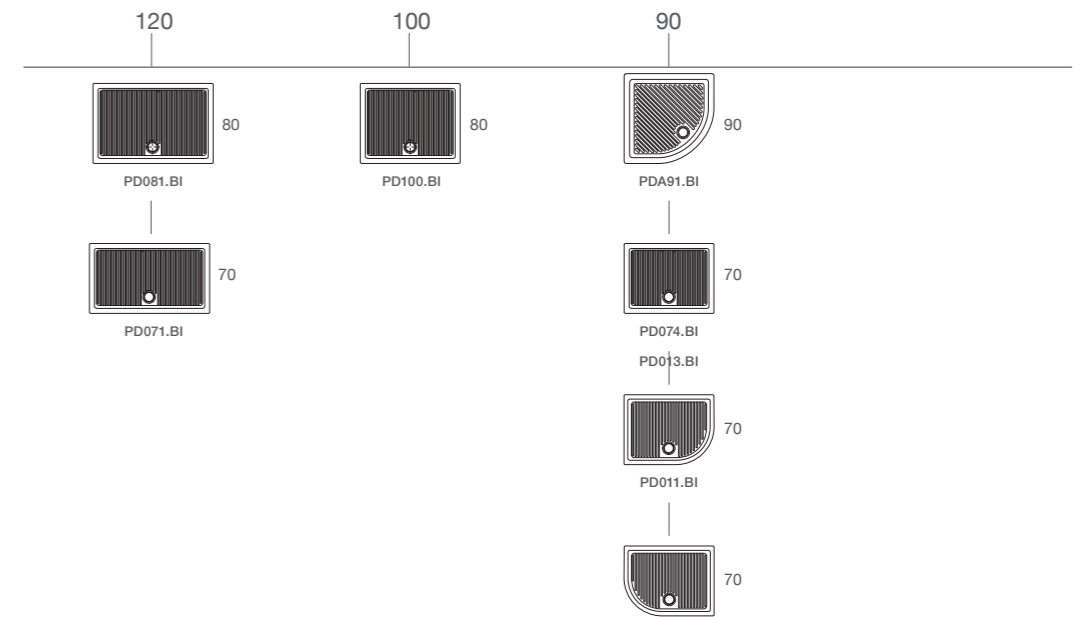

rondo

Piatti doccia
Shower trays
Duschwannen



MULTI®

Vasi e bidet a terra
Floor-mounted WC
and bidet
Floor-mounted WC
and bidet



SENZABRIDA®
No rim
spülrandlos

Vasi sospesi
SENZABRIDA
Wall-hung WC
No rim
Wand Wc
spülrandlos

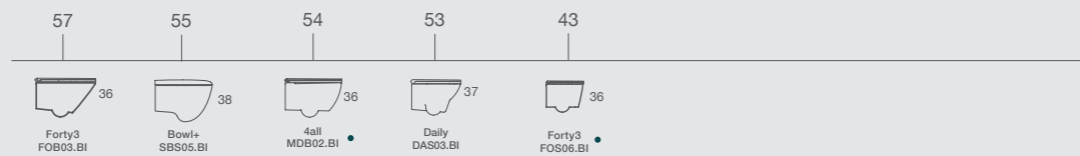

Vasi a terra
SENZABRIDA
Floor-mounted Wc
No rim
Bodenstehende
WC spülrandlos

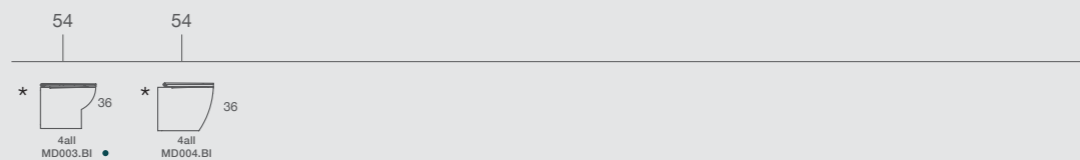

**Vaso bidet
wc-bidet
Wc-bidet**

Vasi-bidet sospesi
Wall-hung WC-bidet
Wand WC-Bidets

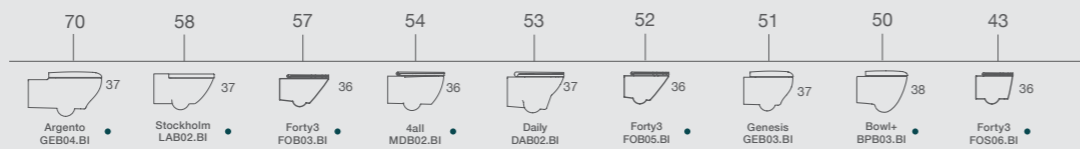

Vaso-bidet a terra
Floor-mounted
WC-bidet
Bodenstehende
WC-bidet

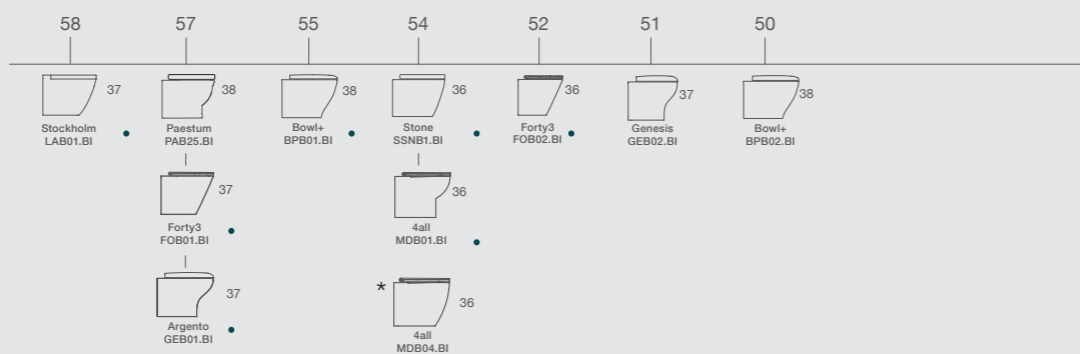

Monoblocco
Close couple WC
wc mit
Spülkasten mit
Bidet funktion

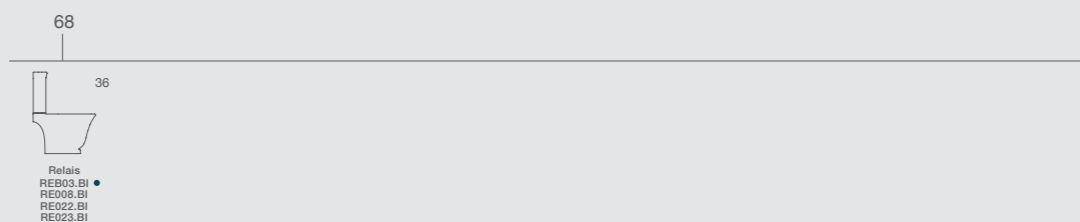

**Orinatoio
Urinals
Urinale**

Orinatoio sospesi
Wall-hung urinals
Wand urinale

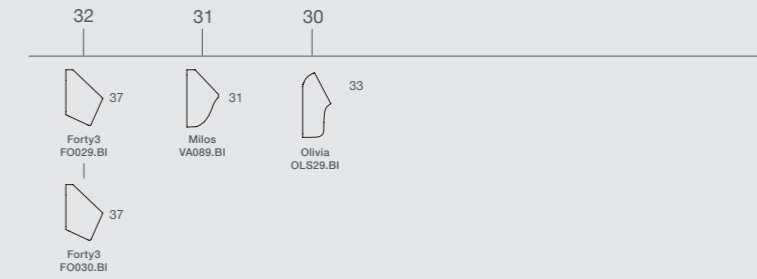

Orinatoio a terra
Floor-mounted
urinals
Stand urinale

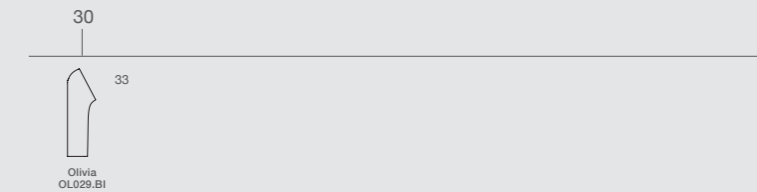

**Disabili e terza età
Disabled and old people
Behinderte und ältere Menschen**

Lavabi sospesi
Wall-hung basins
Wand Waschtische

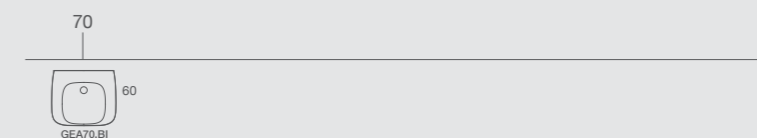

Lavabi ergonomico
Ergonomic basin
Ergonomischer
Waschtisch

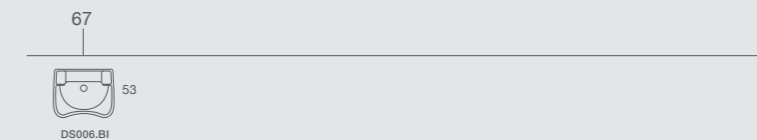

Vasi sospesi
Wall-hung WC
Wand Wc

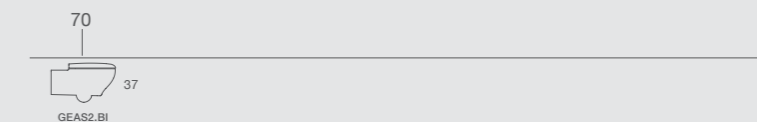

Vasi e bidet a terra
Floor-mounted WC
and bidet
Bodenstehende
WC und bidet

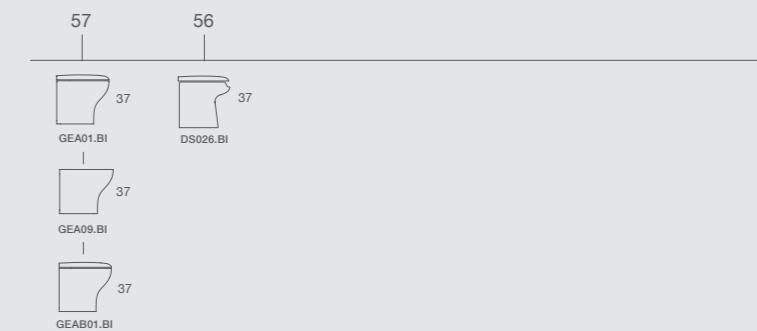

Piatti doccia
Shower trays
Duschwanne

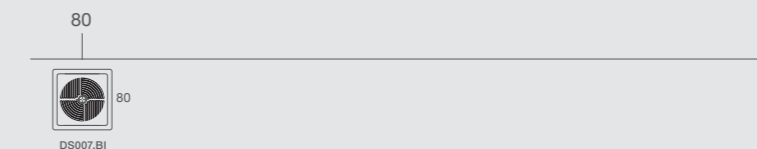

Vasche da bagno
bathtubs
badewannen

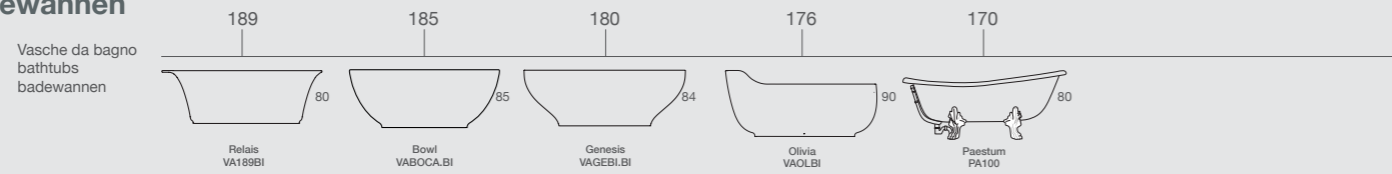

Lavabi d'arredamento
vanity basins
zier Waschtische

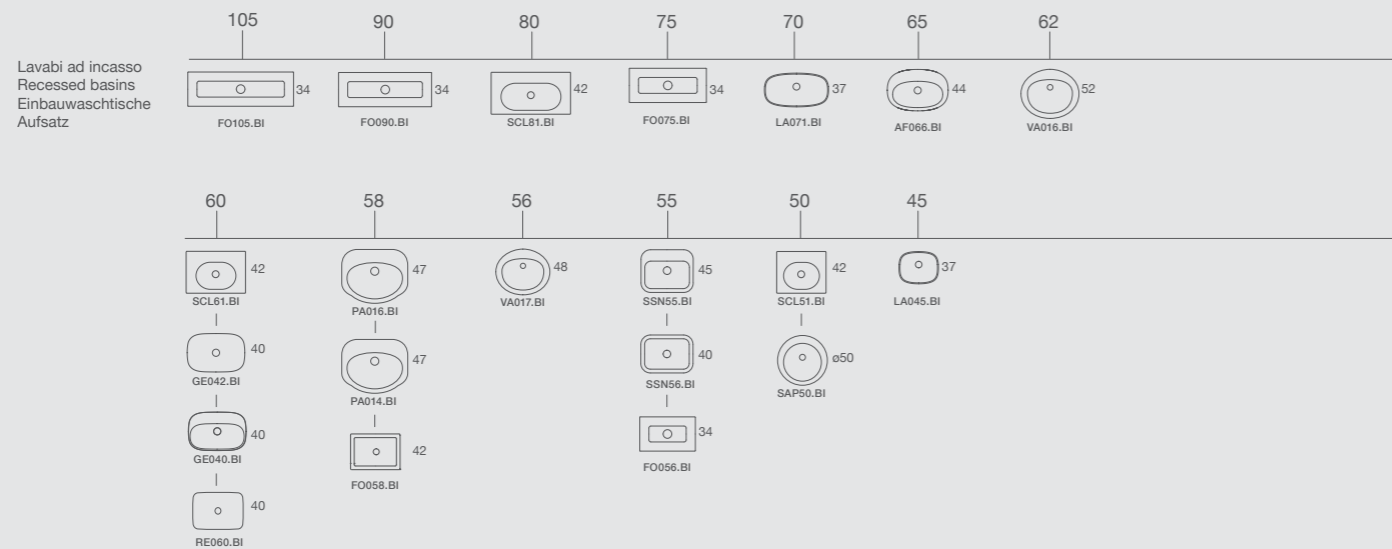
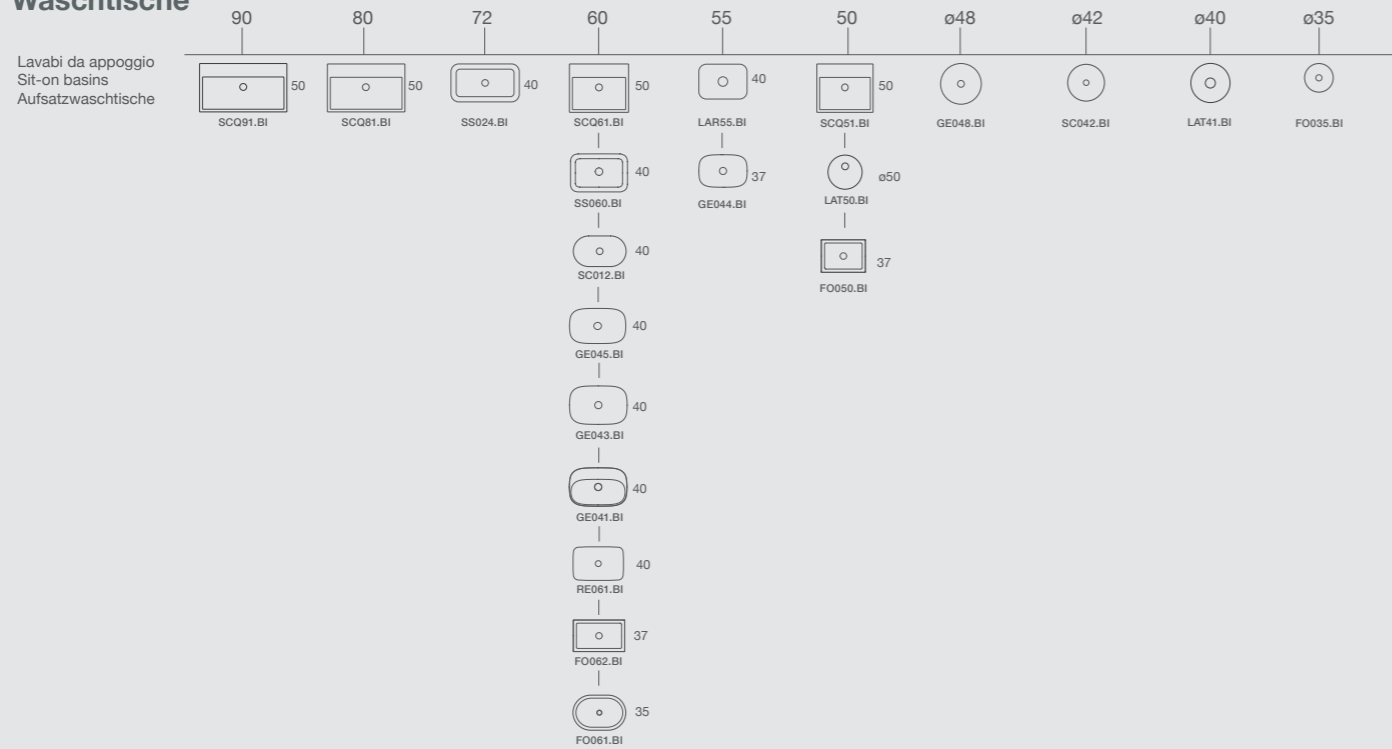

Lavabi sottopiano
Under-top basins
Einbauwaschtische
Untersatz

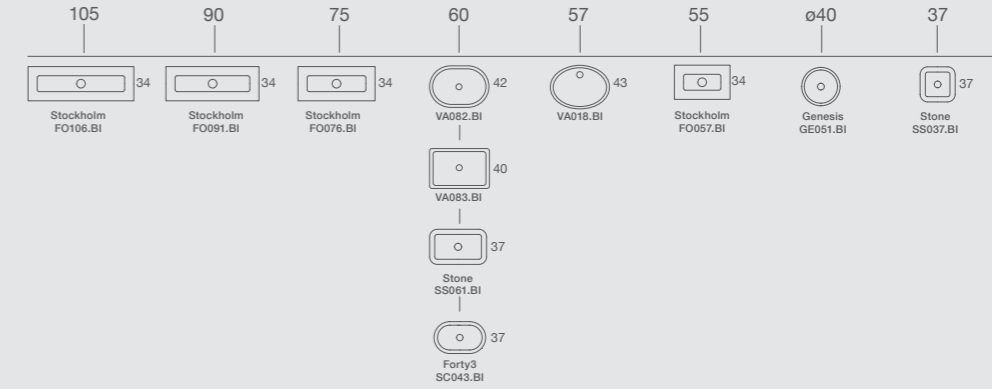

Lavabi semincasso
Semi-recessed basins
Halbeinbauwaschtische

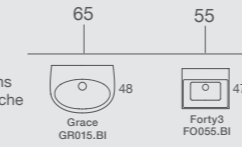

Lavabi monoliti
Free-standing
monolith basin
Monolith waschtische

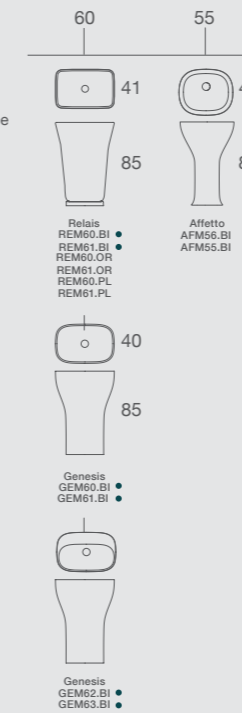

Mobili arredo bagno
bathroom furniture
badeinrichtungen

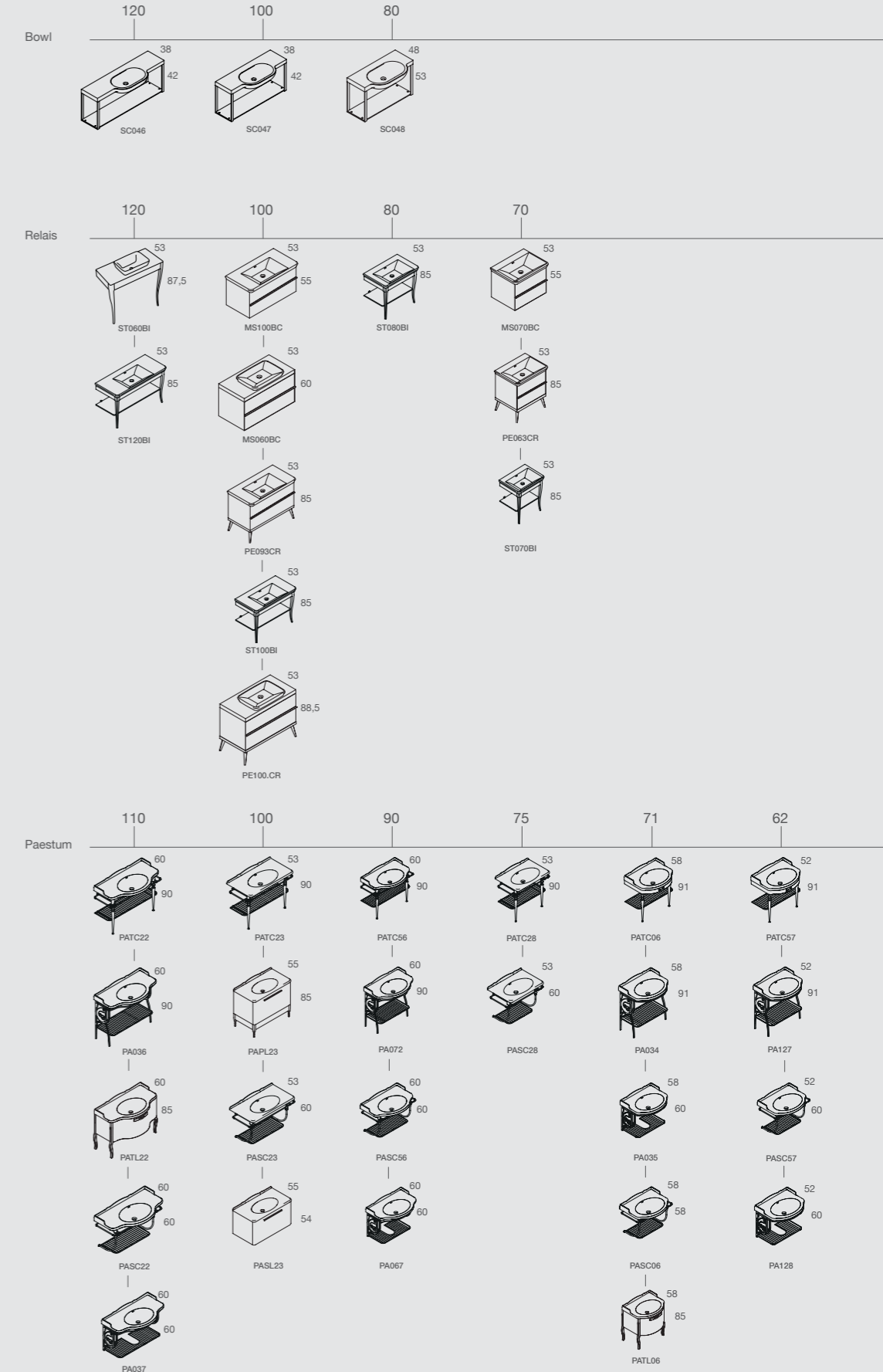
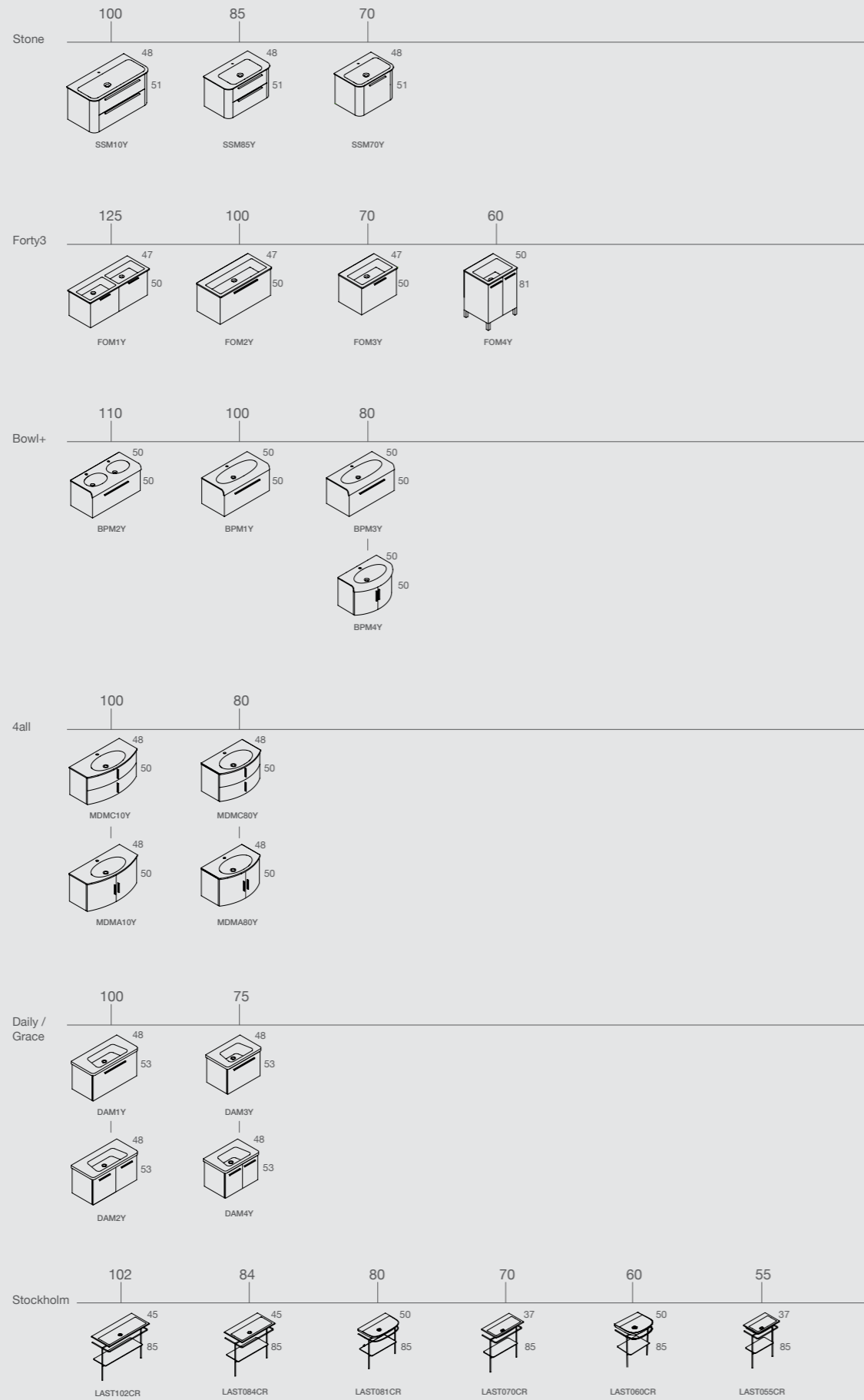

Per le finiture degli arredi consultare il listino in vigore / The furniture decorations are on the valid price list / Die Möbelverzierungen können in der gültigen Preisliste angesehen werden.

**Mobili a colonna
high cabinets
hochschränke**

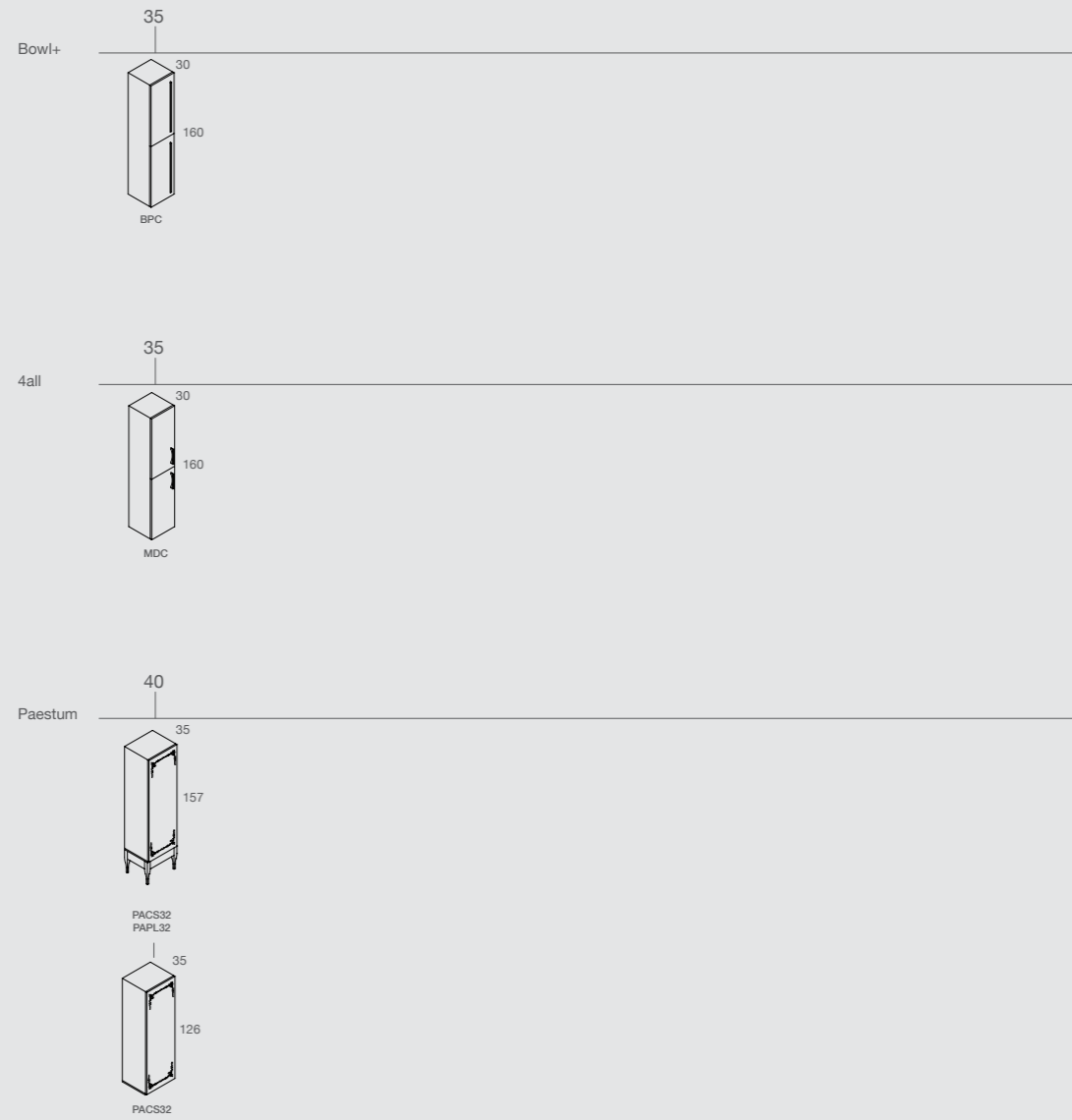

**Specchiere
mirror
spiegel**

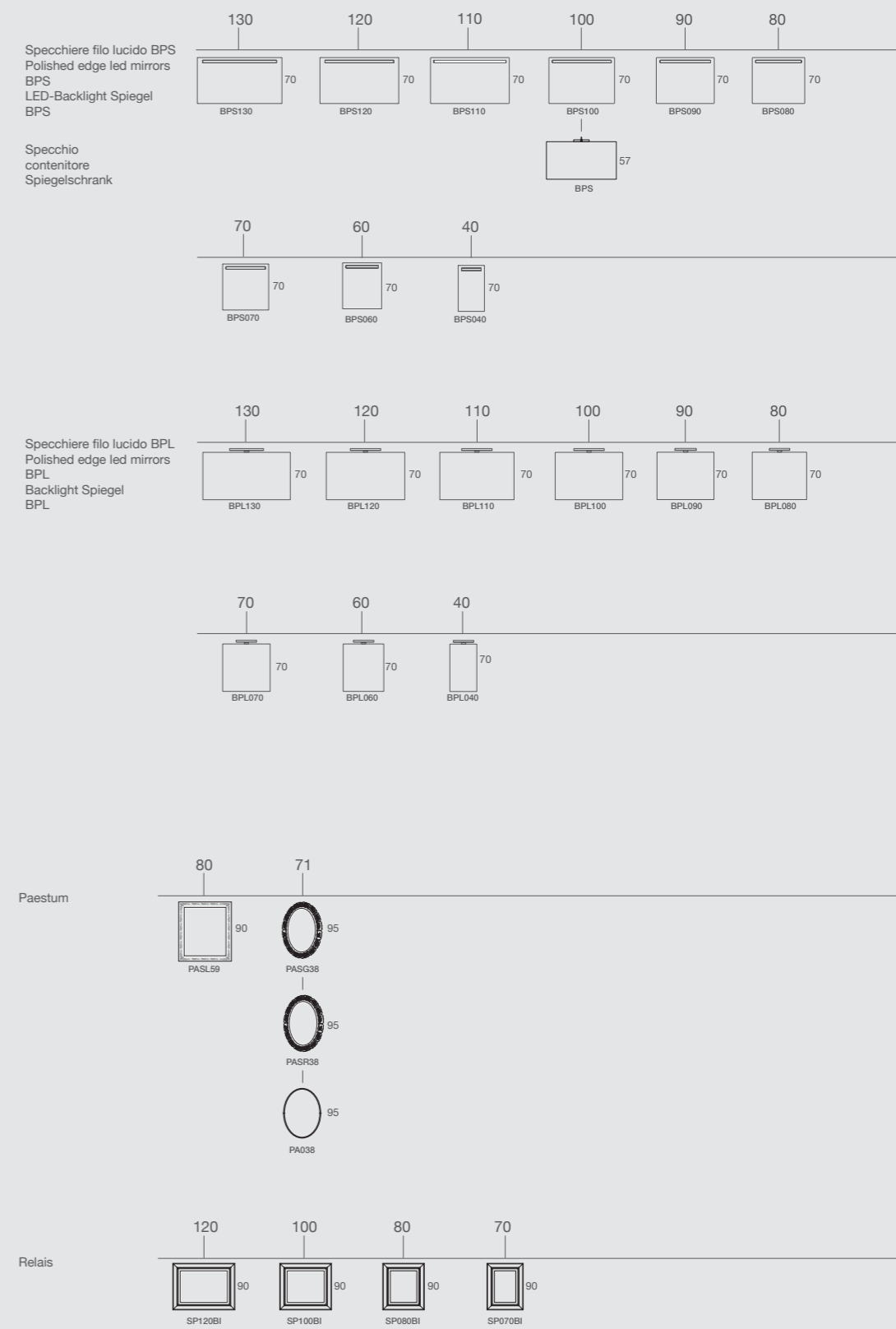

Articoli complementari
complementary items
komplementärprodukte

| | |
|---|--|
| <p>Pilozzi Sinks Ausgussbecken</p> | <p>60 46 50 40 44 35</p> <p>VA044.BI VA043.BI VA042.BI</p> |
| <p>Lavapanni Wash sinks Waschtrog</p> | <p>48 40</p> <p>VA046.BI</p> |
| <p>Lavabi sospesi Wall-hung basins Hängende Waschtische</p> | <p>50 41 50 41 35 35</p> <p>VA020.BI MI012.BI MI013.BI</p> |
| <p>Lavabi ad incasso Recessed basins Einbauwaschtische Aufsatz</p> | <p>50</p> <p>VA019.BI</p> |
| <p>Vaso alla turca Squatting closets Hocktoilette</p> | <p>60 46</p> <p>VA069.BI</p> |
| <p>Cassetta alta universale Universal high cistern Hochhängender Spülkasten, Universale</p> | <p>42 20</p> <p>VA009.BI</p> |

Ceramica Globo spa

Loc. La Chiusa . 01030 . Castel Sant'Elia - (VT) . Italy
Tel+39 0761 18731 . Fax+39 0761 515168

Showroom . Corso Monforte, 15 . 20122 Milano

Tel+39 02 36521510 .

Mail monforte15@ceramicaglobo.com

Globo Concept Shop . Shop C, Ground Floor

336-342 Lockhart Road . Wanchai, Hong Kong

Tel. +(852) 2988 1904 . Fax +(852) 2988 1147

info@ceramicaglobo.com

Il marchio ed il logo **GLOBO**® sono marchi registrati.

Ceramica Globo S.p.a. diffida l'utilizzo dei propri marchi, loghi, nomi di dominio e ragione sociale anche nei Paesi in cui non sono registrati;

È vietato pertanto qualsiasi utilizzo senza il consenso della Ceramica Globo S.p.a.

Tutti i diritti qui non espressamente richiamati sono riservati. Tutte le immagini contenute nel presente catalogo sono di proprietà di ceramica Globo.

GLOBO® brand and logo are registered trademarks.

Ceramica Globo S.p.a. warns to the use of their trademarks, logos, domain names and business name, even in countries where they are not registered.

It is therefore prohibited any use without the consent of Ceramica Globo Spa All rights not expressly granted are reserved.

All images contained in this catalogue are CERAMICA GLOBO 's property.

Die Marke und das Logo **GLOBO**® sind registrierte Marken.

Ceramica Globo S.p.a. warnt vor der Verwendung der eigenen Marken, Logos, Name der Domains und Firmenbezeichnungen auch in

Ländern in denen sie nicht registriert sind. Jegliche Nutzung ist daher ohne Genehmigung von Ceramica Globo S.p.a. verboten.

Alle nicht ausdrücklich gewährten Rechte sind vorbehalten.

follow us



DESIGN PLUS



ADIMEMBER



Concept and graphics

Domenico Orefice Design Studio

Photo

Walter Monti

Styling e art buying :

Katiuscia Ragazzo

Ilaria Gerli

Texts by :

Lara Morandotti

Thanks to

Flos, Wall&Decò

Print

O.G.M.

2016 - all rights reserved®