

Carnevale

A central logo for Petraccer's. It is enclosed in a black square with a thin yellow border. At the top, the word "PETRACER'S" is written in a bold, yellow, serif font, arched over a white unicorn. The unicorn is depicted in a rearing position, facing left, with a single horn and a flowing mane. Below the unicorn, the text "PREGIATE CERAMICHE ITALIANE" is written in a smaller, yellow, serif font.

Veneziano

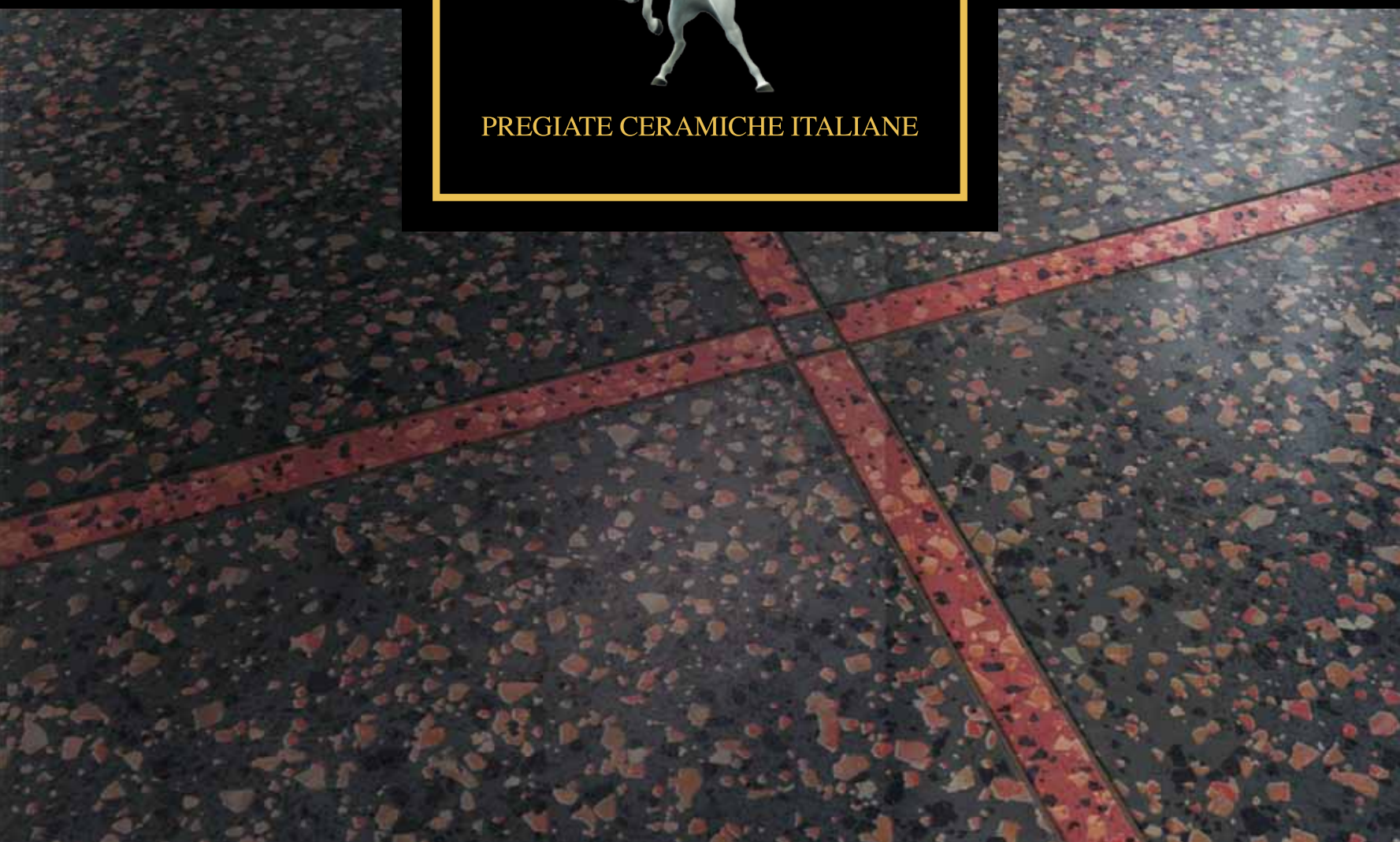



Carnevale Veneziano

Un'altra storia.

di

Il travestimento è costume.

Disguise is the tradition.

伪装为衣装，

Маскировка, это приятно.





Mille coriandoli a spargere colore e festa, lo sguardo è catturato, sedotto dalla profondità delle sfumature. Si ispira al battuto veneziano questo progetto ceramico che grazie agli inserti lineari unisce libertà creativa e regola geometrica. Carnevale Veneziano è la materia che si fa poesia, uno stile che interpreta la tradizione e sapientemente la rinnova. Una collezione dal sapore retrò, per chi vuole un pavimento che incanta con la magia di un effetto insieme sobrio e potente.

A thousand confetti spreading joy and colour. The gaze is attracted, seduced by the deep nuances. This project takes inspiration from the battuto veneziano, and uses ceramic linear inserts to combine creative freedom and geometric rigour. Carnevale Veneziano is matter turned into poetry, with a style that celebrates tradition while skilfully rearticulating it. A retro collection, created for anyone who wants a floor with all the magic of a simple, yet powerful effect.

如同婚礼上飘然洒落的纸屑，五彩缤纷，喜庆夺人。这款产品传古典威尼斯地面之神韵、凭借陶瓷的线形尽显其独特的自由与几何魅力。威尼斯嘉年华是诗歌的源泉，是诠释传统发扬传统美的一种独特方式，专为钟情于冷静与力量型人士横空缔造。

Тысячи многоцветных сверкающих крошек, передающие атмосферу радужного праздника, ухваченного зрением, соблазненным глубиной растяжек и разнообразия цветов. Вдохновение этот керамический проект находит в Венецианском стиле которая благодаря линейным внедрениям декоративных элементов прекрасно объединяющей свододу творчества и правила геометрии. Карнавалле Венециано — это материя которая творит поэзию, стиль который передает традиции и сознательно их обновляет. Это коллекция со вкусом ретро, для тех кто хотят полы передающие волшебным образом, эффект нежности и силу.





80 x 80
beige



14 x 80
legno



14 x 14
legno







80 x 80
bianco



16 x 80
beige



16 x 16
beige



80 x 80
beige





80 x 80
beige9 x 88
legno

Se ami il trucco non temi l'inganno.
Embrace the trickery to avoid deception.
爱欺骗者不会害怕被欺骗。
Если любишь фокусы, не бойся обмана.



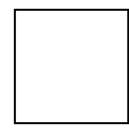

80 x 80
beige

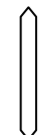

9 x 88
legno



80 x 80
beige



9 x 88
legno



8 x 8
108306





80 x 80
beige



8 x 80
rosso



8 x 8
rosso





80 x 80
beige

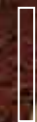

8 x 80
rosso



8 x 8
rosso





Il centro della scena è dove sei tu.

Center stage is where you are.

舞台之中心为你之所在。

Центр событий, там где находишься ты сам.





80 x 80
bianco



8 x 80
nero



8 x 8
nero



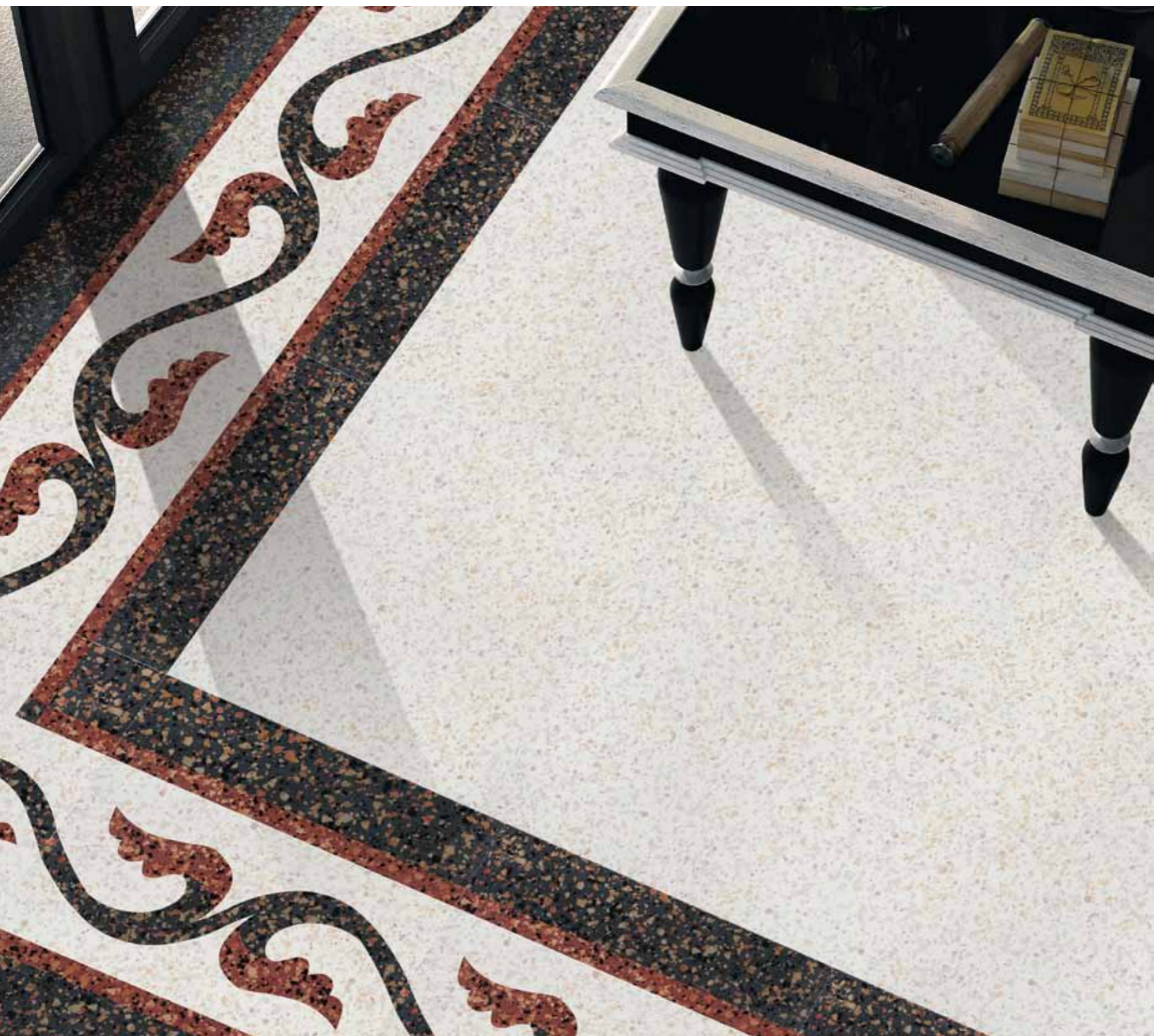



80 x 80
bianco



16 x 80
nero



16 x 16
bianco



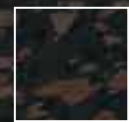

80 x 80
nero

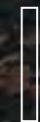

4 x 80
rosso



4 x 4
nero



80 x 80
bianco



4 x 80
nero



4 x 4
bianco





Maschera i tuoi vizi, non i tuoi sogni.

Mask your vices, not your dreams.

墮落不是夢想。

Скрывай свои недостатки а не свои мечты.

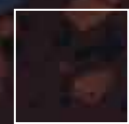

80 x 80
rosso

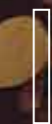

8 x 8
beige



8 x 8
rosso



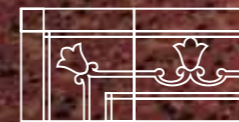
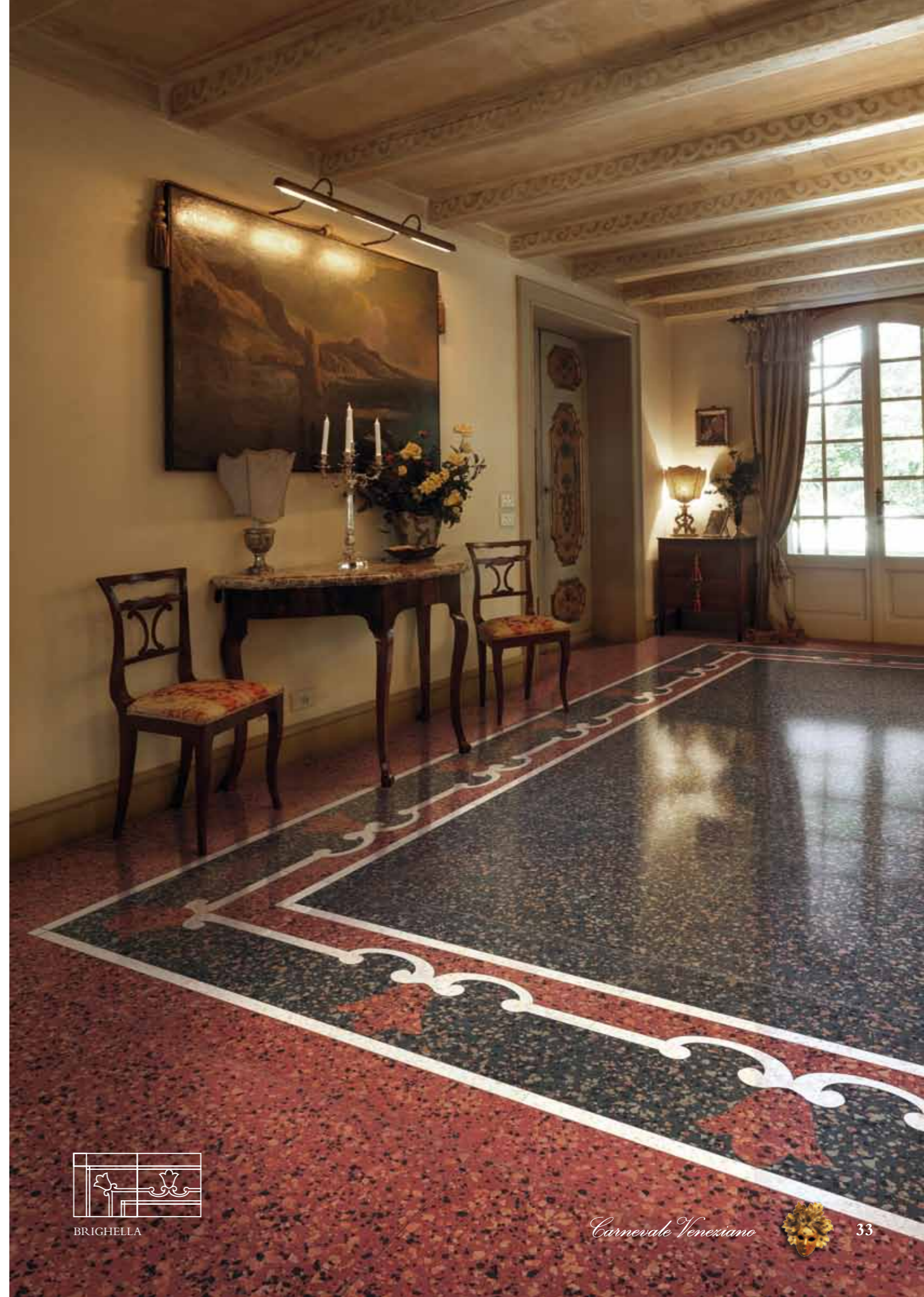
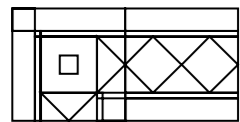





80 x 80
rosso

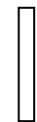

8 x 80
nero



8 x 8
rosso





Chi apre le danze ha sempre qualcuno che lo segue.
Whoever opens the dances has always someone who follows him.

起舞者为舞随行。

Тот кто начинает первым имеет далее своих последователей.



80 x 80
beige



8 x 80
rosso



8 x 8
beige





COLORI E FORMATI / COLOURS AND SIZES

BIANCO PEI 5 16x80 8x80 4x80



80x80 cm

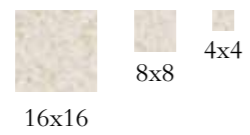

BEIGE PEI 5 16x80 8x80 4x80



80x80 cm

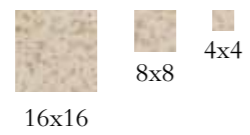

ROSSO PEI 3 16x80 8x80 4x80

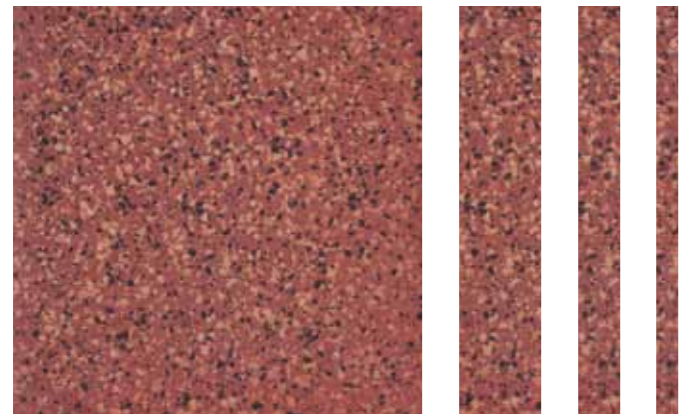

80x80 cm

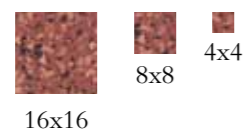

Battiscopa/Skirting 80x8 cm



BIANCO plus PEI 5 16x80 8x80 4x80

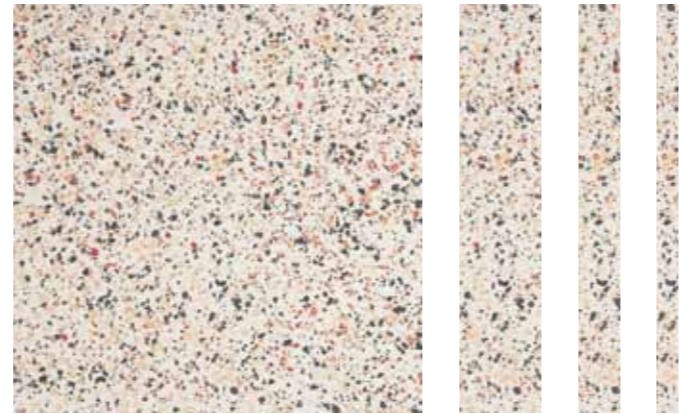

80x80 cm

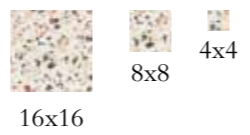

BEIGE plus PEI 5 16x80 8x80 4x80

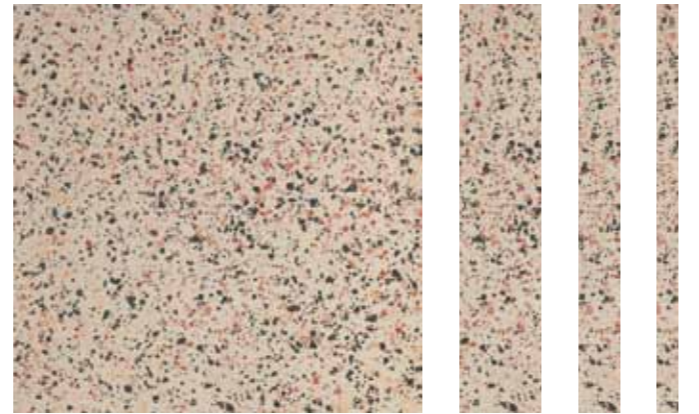

80x80 cm

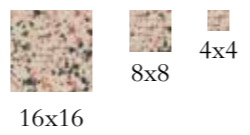

NERO PEI 3 16x80 8x80 4x80



80x80 cm



16x16

CODICI PREZZO / PRICE CODES

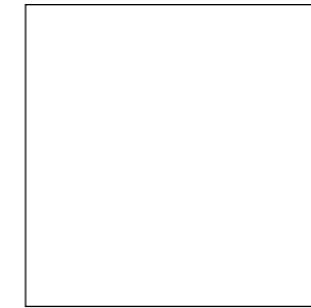

80x80

080

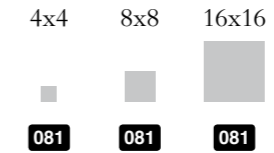

081

081

081

Battiscopa/Skirting 80x8 cm



301

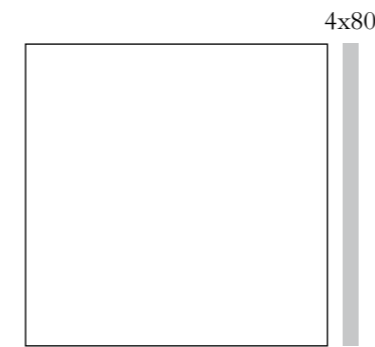

Composizione 4

081

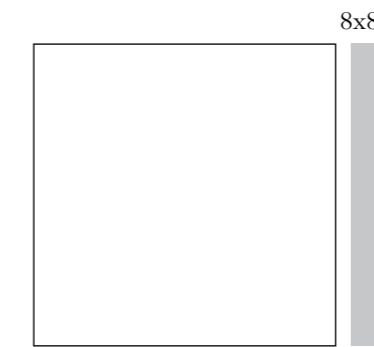

Composizione 8

081

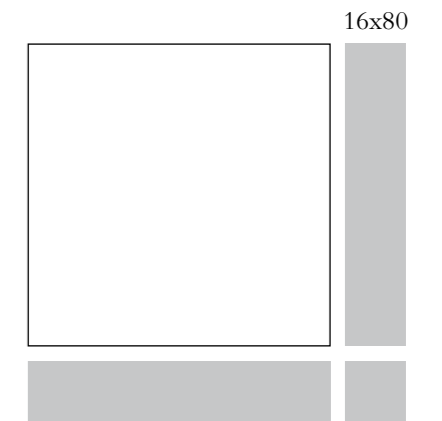

Composizione 16

081

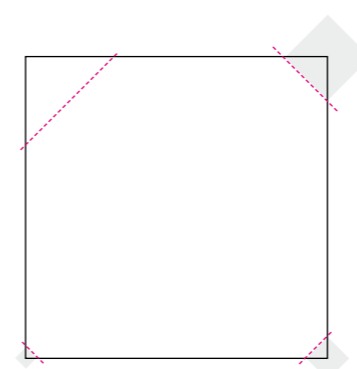

Poligono 80x80
su richiesta / on demand

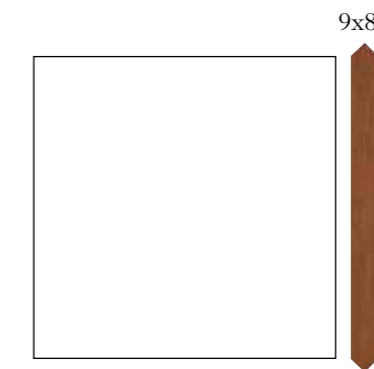

Composizione wood 9

082

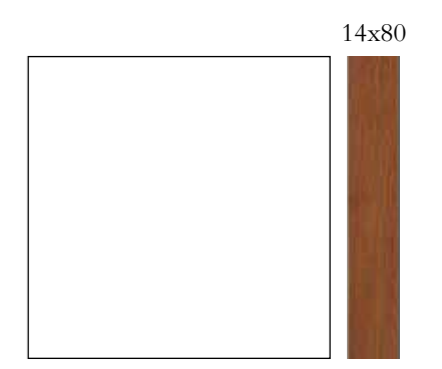

Composizione wood 14

082

- * Posare esclusivamente con colla da legno.
Lay exclusively with glue for wood.
- * Tutti i listelli, tozzetti e losanghe si vendono esclusivamente in scatole complete.
All special trims (listels,dots and lozenges) are sold in full boxes only.
- * Parquet in rovere prefinito due strati bisellato e trattata a mano ad effetto cera.
Wood Oak prefinished listellos layers two chamfer, hand treated for wax effect.
Finitura ANTIBATTERICA - ANTIMACCHIA.
Sanitary and stain top coat.
Finitura in Classe C-S1 di resistenza al fuoco.
Fire Resistance's values: Class C-S1.





DISEGNI, FORMATI E CODICI PREZZO
DESIGN, SIZES AND PRICE CODES

BRIGHELLA

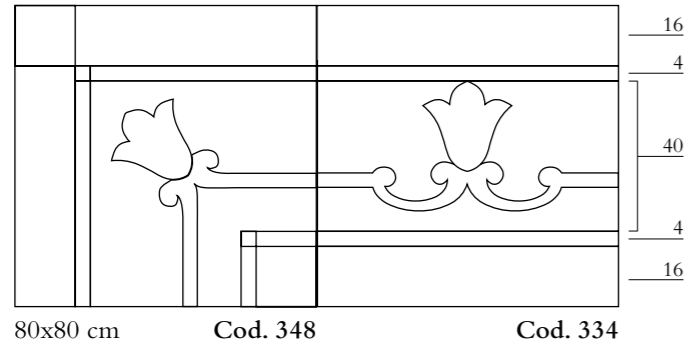

GIANDUIA

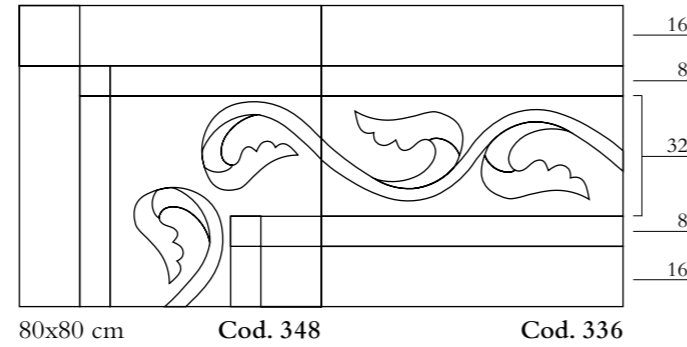

SMERALDINA

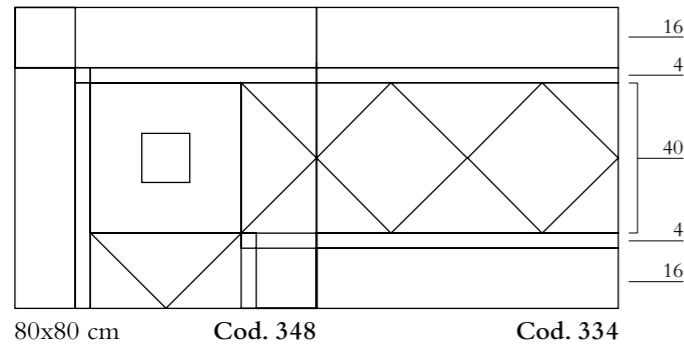

PULCINELLA

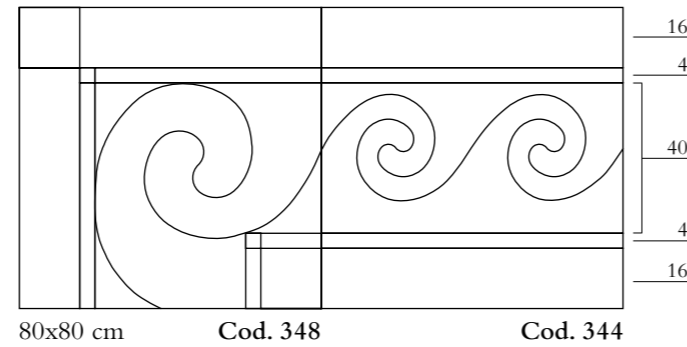

COLOMBINA

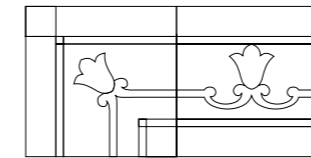
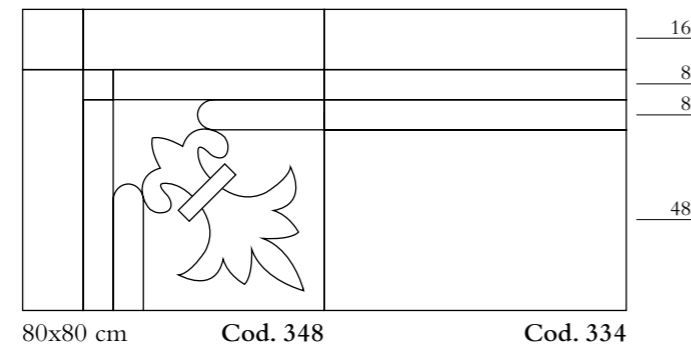

BRIGHELLA



-  1 NERO
-  2 ROSSO
-  3 BIANCO
-  4 BIANCO PLUS
-  5 BEIGE
-  6 BEIGE PLUS

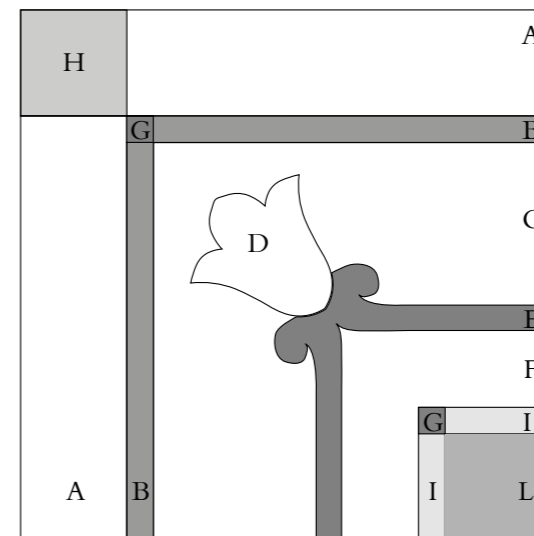

BRIGHELLA ANGOLARE
Cod. 348

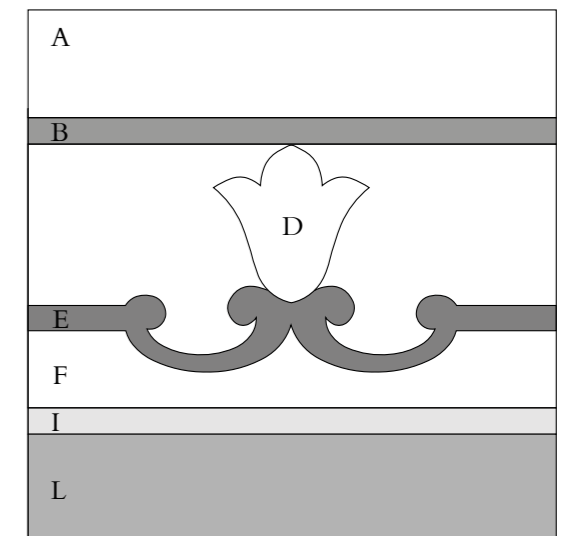

BRIGHELLA LINEARE
Cod. 334

Riempì gli appositi riquadri indicando il numero corrispondente al colore scelto
Please fill in each square with the colour number you select

A B C D E F G H I L



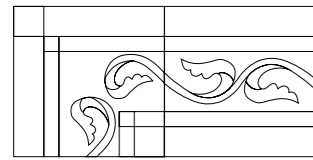

GIANDUIA



-  1
NERO
-  2
ROSSO
-  3
BIANCO
-  4
BIANCO PLUS
-  5
BEIGE
-  6
BEIGE PLUS

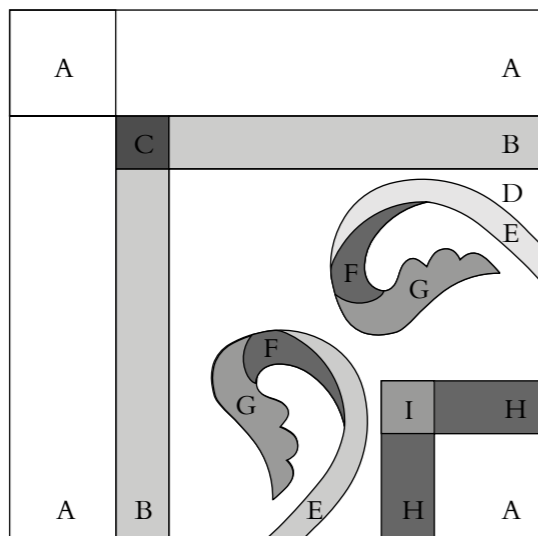

GIANDUIA ANGOLARE
Cod. 348

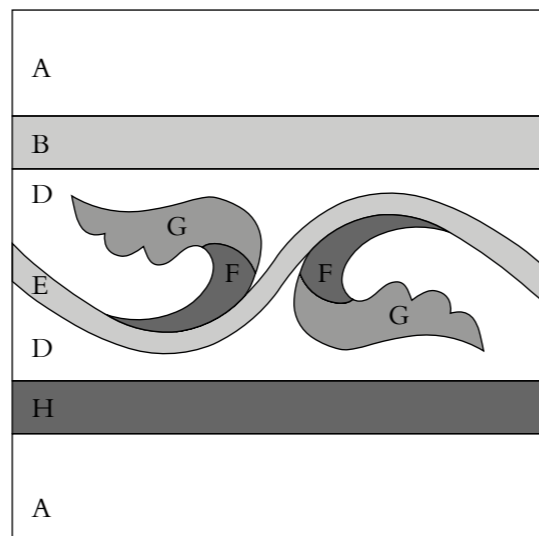

GIANDUIA LINEARE
Cod. 334

Riempi gli appositi riquadri indicando il numero corrispondente al colore scelto
Please fill in each square with the colour number you select

| | | | | | | | | | |
|----------------------|----------------------|----------------------|----------------------|----------------------|----------------------|----------------------|----------------------|----------------------|----------------------|
| <input type="text"/> | <input type="text"/> | <input type="text"/> | <input type="text"/> | <input type="text"/> | <input type="text"/> | <input type="text"/> | <input type="text"/> | <input type="text"/> | <input type="text"/> |
| A | B | C | D | E | F | G | H | I | |

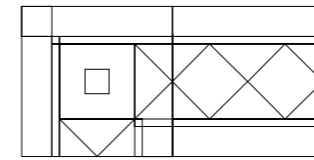

SMERALDINA



-  1
NERO
-  2
ROSSO
-  3
BIANCO
-  4
BIANCO PLUS
-  5
BEIGE
-  6
BEIGE PLUS

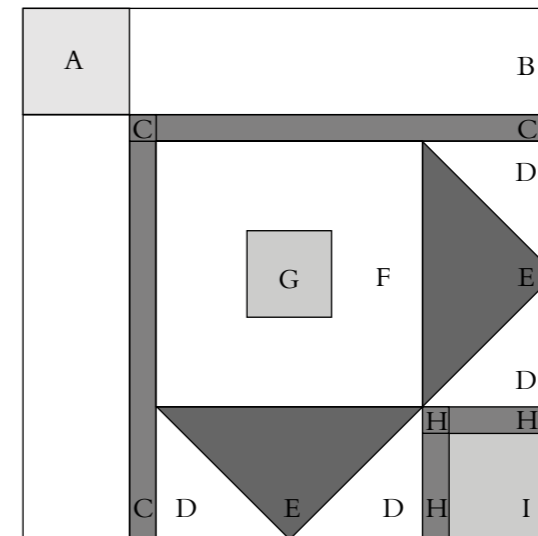

SMERALDINA ANGOLARE
Cod. 348

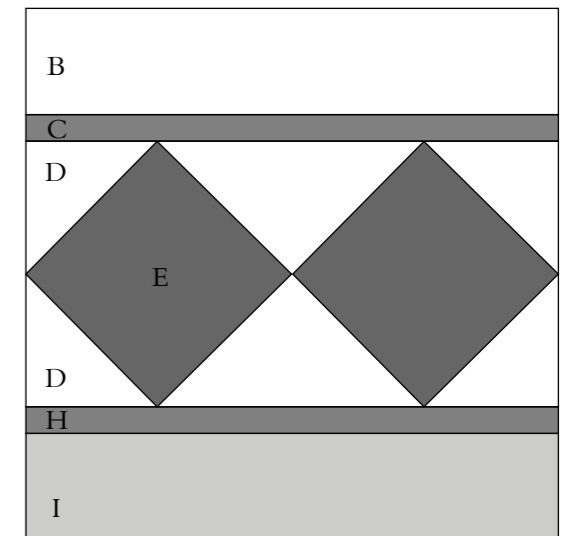

SMERALDINA LINEARE
Cod. 334

Riempi gli appositi riquadri indicando il numero corrispondente al colore scelto
Please fill in each square with the colour number you select

| | | | | | | | | | |
|----------------------|----------------------|----------------------|----------------------|----------------------|----------------------|----------------------|----------------------|----------------------|----------------------|
| <input type="text"/> | <input type="text"/> | <input type="text"/> | <input type="text"/> | <input type="text"/> | <input type="text"/> | <input type="text"/> | <input type="text"/> | <input type="text"/> | <input type="text"/> |
| A | B | C | D | E | F | G | H | I | |



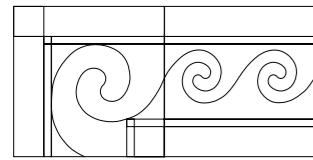

PULCINELLA

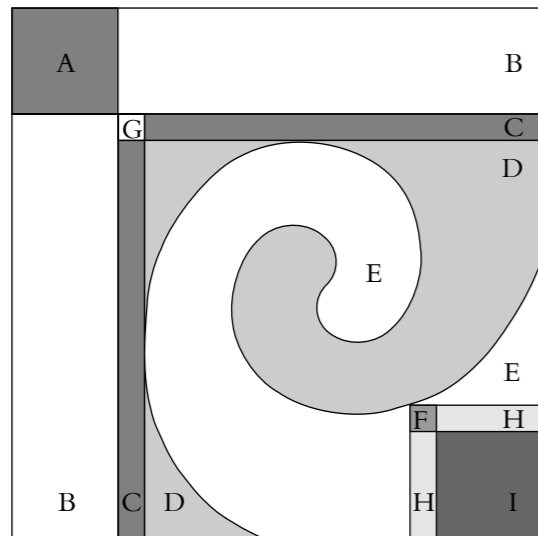

PULCINELLA ANGOLARE
Cod. 348

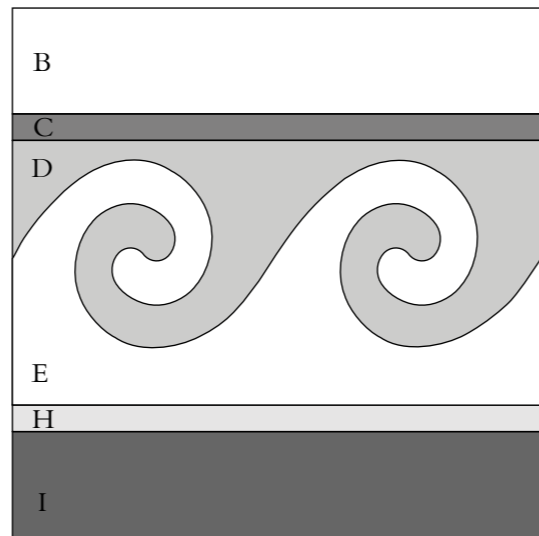

PULCINELLA LINEARE
Cod. 334

Riempi gli appositi riquadri indicando il numero corrispondente al colore scelto
Please fill in each square with the colour number you select

| | | | | | | | | | |
|--------------------------|--------------------------|--------------------------|--------------------------|--------------------------|--------------------------|--------------------------|--------------------------|--------------------------|--------------------------|
| <input type="checkbox"/> | <input type="checkbox"/> | <input type="checkbox"/> | <input type="checkbox"/> | <input type="checkbox"/> | <input type="checkbox"/> | <input type="checkbox"/> | <input type="checkbox"/> | <input type="checkbox"/> | <input type="checkbox"/> |
| A | B | C | D | E | F | G | H | I | |

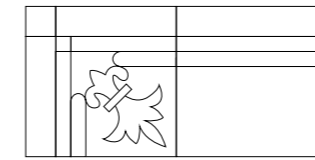

COLOMBINA

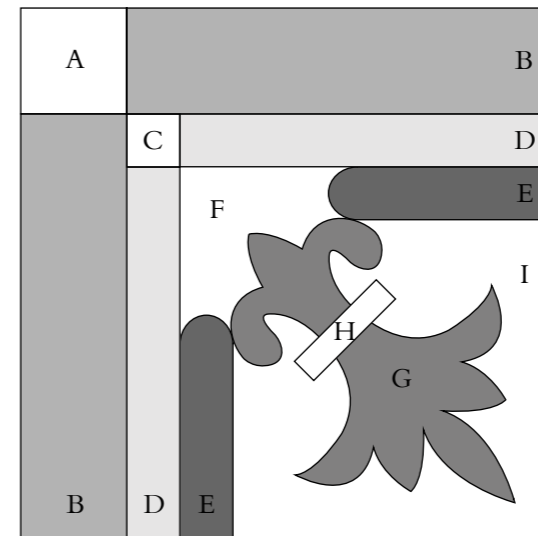
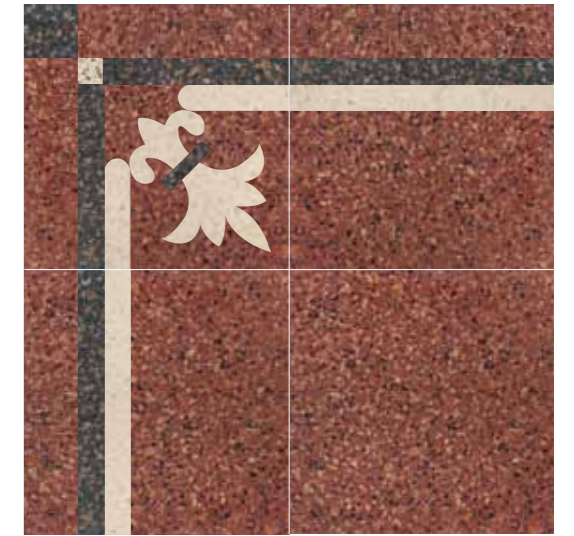

COLOMBINA ANGOLARE
Cod. 348

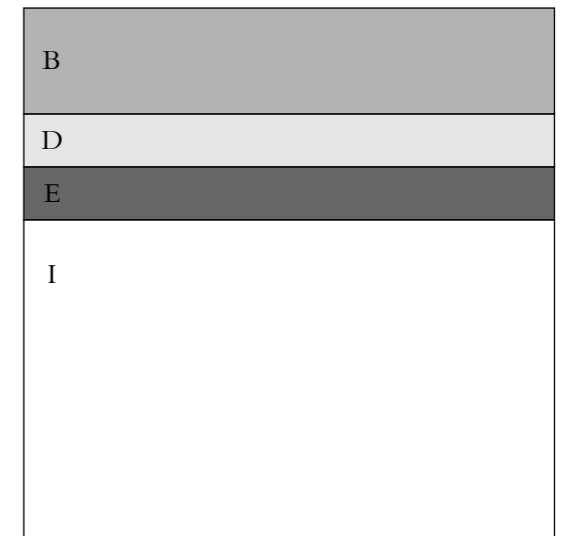

COLOMBINA LINEARE
Cod. 334

Riempi gli appositi riquadri indicando il numero corrispondente al colore scelto
Please fill in each square with the colour number you select

| | | | | | | | | | |
|--------------------------|--------------------------|--------------------------|--------------------------|--------------------------|--------------------------|--------------------------|--------------------------|--------------------------|--------------------------|
| <input type="checkbox"/> | <input type="checkbox"/> | <input type="checkbox"/> | <input type="checkbox"/> | <input type="checkbox"/> | <input type="checkbox"/> | <input type="checkbox"/> | <input type="checkbox"/> | <input type="checkbox"/> | <input type="checkbox"/> |
| A | B | C | D | E | F | G | H | I | |





CARATTERISTICHE TECNICHE TECHNICAL CHARACTERISTICS

| | | | |
|---|--|---|--|
| GRUPPO DI APPARTENENZA <i>BELONGING TO GROUP</i> | | EN 14411 | BIA GL |
| Proprietà fisico chimiche <i>Physical-chemical properties</i> | | Metodo applicato <i>Method applied</i> | Valore <i>Value</i> |
|  | Percentuale di assorbimento <i>Per-cent absorption</i> | UNI EN ISO 10545/3 | < 0,2% |
|  | Resistenza alla flessione <i>Flexural resistance</i> | UNI EN ISO 10545/4 | ≥ 45N/mm ² |
|  | Resistenza all'urto <i>Shock resistance</i> | UNI EN ISO 10545/5 | e>055 |
|  | Resistenza all'abrasione profonda <i>Deep abrasion resistance</i> | UNI EN ISO 10545/6 | 105 mm ³ |
|  | Resistenza all'abrasione superficiale <i>PEI rate abrasion resistance</i> | UNI EN ISO 10545/7 | colori chiari/ <i>light colours</i> PEI 5 colori scuri/ <i>dark colours</i> PEI 3 |
|  | Resistenza agli sbalzi termici <i>Thermal shock resistance</i> | UNI EN ISO 10545/9 | Resistente <i>Resistant</i> |
|  | Resistenza all'attacco chimico <i>Chemical etching resistance</i> | UNI EN ISO 10545/13 | GA |
|  | Resistenza alle macchie <i>Stain resistance</i> | UNI EN ISO 10545/14 | CLASSE 5 <i>CLASS 5</i> |
|  | Cessione sostanze pericolose <i>Releasing of dangerous substances</i> | UNI EN ISO 10545/15 | Pb 0,0 - Cd 0,0 |
|  | Colori stabili alla luce e ai raggi UV <i>Colour stability to light and UV rays</i> | UNI EN ISO 10545/16 - DIN51094 | Resistente <i>Resistant</i> |
|  | Resistenza al gelo/disgelo <i>Frost/Thaw cycle resistance</i> | UNI EN ISO 10545/12 | Resistente <i>Resistant</i> |

PESI ED IMBALLI WEIGHT AND PACKAGING

| Tipologia prodotto <i>Product Type</i> | Formato (cm) nominale <i>Size (cm) nominal</i> | n°pezzi/scatola <i>Pcs./box</i> | mq/scatola <i>Sq.Mts./box</i> | Kg/scatola <i>Kg./box</i> | mt lineari/scatola <i>Linear Mt./box</i> | Scatole/pallet* <i>Boxes on pallet</i> | mq/pallet* <i>Sq.Mts. on pallet</i> | Kg/pallet* <i>Kg. on pallet</i> |
|---|---|------------------------------------|----------------------------------|------------------------------|---|---|--|------------------------------------|
| Fondo | 80x80 | 2 | 1,28 | 33,00 | - | 35 | 44,80 | 1175 |
| Listello | 4x80 | 16 | 0,512 | 13,20 | - | - | - | - |
| Listello | 8x80 | 8 | 0,512 | 13,20 | - | - | - | - |
| Listello | 16x80 | 4 | 0,512 | 13,20 | - | - | - | - |
| Tozzetto | 4x4 | 64 | 0,1024 | 2,65 | - | - | - | - |
| Tozzetto | 8x8 | 16 | 0,1024 | 2,65 | - | - | - | - |
| Tozzetto | 16x16 | 4 | 0,1024 | 2,65 | - | - | - | - |
| Battiscopa | 8x80 | 8 | - | 13,20 | 6,4 | - | - | - |

* Dimensione paletta fondi 80x120.





PETRACER'S Ceramics S.r.l. Socio Unico

Via Ghiarola Nuova, 228
41042 Fiorano Modenese (MO) - Italy
www.petracer.it - info@petracer.it
tel. +39 0536 812163 - fax +39 0536 889848