

OVER

TAILORMADE
STOCCO

OVER

Oltre la funzionalità e l'organizzazione nel bagno si fa spazio una nuova idea di bellezza e benessere. Senza tempo, senza confini.
Over your imagination.

Over è un progetto Tailormade Stocco

Besides the functionality and organization, a new idea of beauty and wellness takes place in in the bathroom. Timeless, boundless.
Over your imagination.

Over is a Tailormade Stocco project

Además de la funcionalidad y de la organización, una nueva idea de belleza y de bienestar se lleva a cabo en el baño. Sin tiempo, sin límites.
Over your imagination.

Over es un proyecto Tailormade Stocco

Помимо функциональности при организации пространства ванной комнаты большое значение уделено воплощению новой идеи эстетики wellness.
Без времени, без ограничений.
Over your imagination.

Over - Это проект Tailormade Stocco

TAILORMADE
STOCCO



“ Over è un sistema aperto a mille interpretazioni, semplice e flessibile. Una struttura solida, da combinare a piacere, pronta a vestirsi in un elegante mix di soluzioni e mostrare una personalità sofisticata, sempre più unica. Comprende una gamma estesa di elementi: mobili portalavabo, basi, top mensole, lavabi sospesi, colonne, pensili, nicchie e differenti tipologie di aperture. Materiali, colori, dimensioni, finiture vanno oltre l’immaginazione. ”



Over is a system which is open to a thousand interpretations, simple and flexible. A solid structure, to be combined as you want, ready to dress in an elegant mix of solutions and able to show a sophisticated personality, more and more unique. It includes a wide range of items: washbasin units, base units, top consoles, suspended washbasins, columns, hanging units, open compartments and different types of openings. Materials, colors, sizes, finishes are beyond imagination.

Over es un sistema que está abierto a mil interpretaciones, simple y flexible. Una estructura sólida, que puede ser combinada como quieras, lista para vestirse en una elegante mezcla de soluciones y capaz de mostrar una personalidad sofisticada, cada vez más única. Incluye una amplia gama de artículos: bajos porta lavabo, bajos, encimeras, lavabos suspendidos, columnas, armarios suspendidos, compartimientos abiertos y diferentes tipos de aperturas. Los materiales, colores, tamaños, acabados son más allá de la imaginación.

Over - это система тысячи интерпретаций, простая и гибкая. Надежная структура комбинируется по Вашему вкусу, готовая перевоплотиться в элегантном миксе решений, демонстрируя неповторимую персональную утонченность. Состоит из обширной гаммы элементов: базы под раковину, наборные базы, полки-столешницы, подвесные раковины, колонны, шкафчики, ниши с различными типами открывания. Разнообразие материалов, цветов, размеров, отделок поражает воображение.

More than a million combinations

Oltre un milione di combinazioni



Более миллиона комбинаций



Más de un millón de combinaciones



Index



Manhattan
skyline



42
Armonia
toscana



66
Paris,
je t'aime

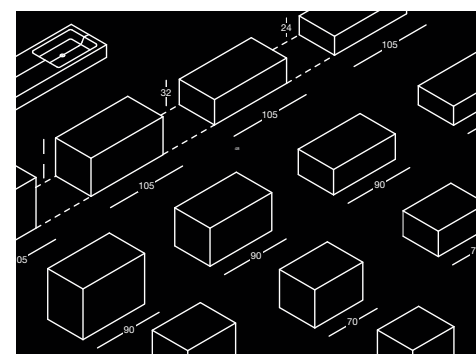

96
Tailormade
design



Manhattan *skyline*

Un appartamento luminoso con vista sulla città. Grandi pareti vetrate, soluzioni architettoniche contemporanee, ampi spazi da organizzare in libertà. Nell'area bagno i toni neutri si abbinano a materiali dall'aspetto naturale, ma dall'anima hi-tech.

A sunny apartment with city view. Large glass walls, contemporary architectural solutions, plenty of space to organize freely. In the bathroom neutral tones are combined with natural-looking materials, which have an hi-tech soul.

Un apartamento soleado con vista a la ciudad. Grandes paredes de cristal, soluciones arquitectónicas contemporáneas, mucho espacio para organizarse libremente. En el cuarto de baño los tonos neutros se combinan con materiales de aspecto natural, que tienen un alma de alta tecnología.

Залитая солнечным светом квартира с великолепным видом на город. Прозрачные стеклянные стены, современные архитектурные решения, огромные свободные пространства. Зона ванной комнаты выполнена в нейтральных тонах с использованием различных натуральных материалов в единой стилистике hi-tech.







Il lavabo integrato in Hpl finitura legno ha vasche in acciaio rivestito, con scarico libero e fondo inclinato removibile.

The integrated washbasin in HPL wood finish has basins in coated steel, with free discharge waste and inclined removable bottom.

El lavabo integrado en HPL acabado madera tiene lavabos con acero revestido, con desagüe libre y fondo inclinado removible.

Интегрированная столешница из HPL в отделке под дерево с раковинами, выполненными из облицованной стали, со свободным сливом и съёмным наклонным дном.



*Interno ed esterno
si confondono.*

Gli spazi rivelano nuove attitudini.

Inside and outside merge.
The spaces reveal new attitudes.

Dentro y fuera se funden.
Los espacios revelan nuevas actitudes.

Внутреннее и внешнее
объединяются. Пространства
приоткрывают новые возможности.







Area relax con lavabi freestanding Eklò rivestiti in gres porcellanato 'Luci di Venezia'. Vasca Origami Extension in Cristalplant con supporto laterale in legno.

Relax area with freestanding Eklò basins coated with porcelain gres "Luci di Venezia". Origami Extension bathtub in Cristalplant with wooden side support.

Area de relax con lavabos al suelo Eklò revestidos con gres de porcelana "Luci di Venezia". Bañera Origami Extension en Cristalplant con soporte lateral de madera.

Зона отдыха со свободно стоящими раковинами Eklò в отделке из керамогранита серии 'Luci di Venezia'. Ванна Origami Extension из Cristalplant с ножкой из дерева.







Autumn in Manhattan









Over si presta a infinite possibilità di composizione. Nelle pagine seguenti, alcune idee ed esempi.

Over is suitable for endless possibilities of composition. In the following pages, some ideas and examples.

Over se presta a infinitas posibilidades de composición. En las siguientes páginas, algunas ideas y ejemplos.

Over воплощается в бесконечном количестве композиций. На следующих страницах - некоторые идеи и примеры.



Lavabi integrati

Over comprende una gamma estesa di lavabi in ceramica, Corian, Fenix, Hpl, Kerlite, Laminam, Mineralmarmo, vetro integrati nel top del mobile.
Lo spessore maggiorato del top in Hpl crea un segno grafico nitido e forte.



Integrated washbasins

Over includes a wide range of washbasins made of ceramic, Corian, Fenix, Hpl, Kerlite, Laminam, Mineralmarmo, glass, integrated in the top of the unit.
The increased thickness of the top in HPL creates a clear and strong graphic design.

Lavabos integrados

Over incluye una amplia gama de lavabos de cerámica, Corian, Fenix, Hpl, Kerlite, Laminam, Mineralmarmo, vidrio, integrados en la encimera de los muebles.
El aumento de espesor de la parte superior en HPL crea un diseño gráfico claro y fuerte.

Интегрированные раковины

Over предлагает широкий выбор раковин - из керамики, Corian, Fenix, Hpl, Kerlite, Laminam, Mineralmarmo, стекла - интегрированных в столешницу мебели.
Увеличенная толщина топа из Hpl определяет четкий и стильный графический образ.







Nicchie

I vani a giorno possono essere posizionati in orizzontale o in verticale, secondo l'altezza delle basi.



Open compartments

The open compartments can be positioned horizontally or vertically, depending on the height of the units.

Niches

Los compartimentos se pueden colocar horizontalmente o verticalmente, dependiendo de la altura de los muebles.

Ниши

Открытые ниши могут располагаться горизонтально или вертикально, в зависимости от высоты баз.







Palette colori

Le basi possono essere laccate in 27 colori con finitura opaca o lucida e 4 colori metallizzati.



Color guide

The units can be lacquered in 27 colors with matt or gloss finish and 4 metallic colors.

Tabla colores

Los muebles pueden ser lacados en 27 colores con acabado mate o brillante y 4 colores metalizados.

Цветовая гамма

Базы могут быть окрашены в любой из 27 цветов в матовой или глянцевой отделке или в любой из 4 металлизированных цветов.





Armonia *toscana*

Il casale antico, immerso nel dolce paesaggio, ritrova l'atmosfera solare e l'armonia con la natura. L'intervento architettonico nell'area bagno wellness unisce il presente alle radici, fondendo i materiali del passato con le esigenze e il gusto d'oggi.

The old farmhouse, nestled in the gentle countryside, regains the solar atmosphere and the harmony with nature. The architectural intervention in the bathroom wellness area merges the present to the roots, fusing old fashioned materials with the needs and tastes of today.

La antigua casa de campo, ubicada en la paisaje suave, recupera la atmósfera solar y la armonía con la naturaleza. La intervención arquitectónica en la zona baño-bienestar combina la presente a las raíces, y fusiona los materiales del pasado con las necesidades y los gustos de hoy.

Античное строение, растворенное в солнечной атмосфере безмятежного пейзажа - всегда в гармонии с природой. Архитектурное перевоплощение зоны ванной в wellness пространство объединяет настоящее и историю, наполняя материалы прошлого современной функциональностью и эстетичностью.







Legno naturale

La mensola in legno diventa base per il lavabo in appoggio. L'impiallaccio in legno, verniciato in acrilico con finitura opaca, è ricavato da piante nodose con naturali spaccature evidenziate dal supporto a contrasto.



Natural wood

The wooden console becomes the support for the sit-on washbasin. The wood veneer, painted in acrylic with matt finish, is made from gnarled trees with natural rifts highlighted by the support in contrast.

Madera natural

La encimera de madera se convierte en un soporte para el lavabo de apoyo. La chapa de madera, pintada en acrílico con acabado mate, se hace de árboles nudosos con grietas naturales destacados por el soporte en contraste.

Натуральное дерево

Деревянная полка превратилась в столешницу для накладной раковины. Шпон натурального дерева покрыт прозрачным матовым акриловым лаком. Он производится из самой узловатой части ствола дерева с неповторимым рисунком прожилок, который проявляется на контрастной основе.









Apertura push-pull

Over è disponibile a scelta con tre tipi di apertura. Il sistema premi-apri assicura praticità d'uso e design nitido.



Push-pull opening

Over is available with a choice of three types of opening. The push-open system ensures easy use and clear design.

Apertura Push-pull

Over está disponible con una opción de tres tipos de apertura. El sistema push-pull garantiza un uso fácil y un diseño claro.

Открытие push-pull

Базы Over имеют возможность выбора одного из трех типов открывания. Система открывания нажатием - это строгий дизайн и практичность в использовании.



Apertura a gola

Il profilo ergonomico della maniglia a gola facilita la presa.



Groove opening
The ergonomic shape of the groove handle provides good grip.

Apertura a gola
La forma ergonómica del tirador a gola ofrece un buen agarre.

Врезная ручка
Эргономичный профиль врезной ручки максимально упрощает открывание.





Specchi

Il sistema Over comprende varie tipologie di specchi filo lucido con telaio in alluminio, attrezzati con mensole, elementi a giorno e accessori, o personalizzati con incisioni e molature design.

Mirrors

The Over system includes various types of polished edge mirrors with aluminum frame, equipped with shelves, open compartments and accessories, also customized with design engravings and grindings.

Espejos

El sistema Over incluye varios tipos de espejos con borde brillante y marco de aluminio, equipado con estantes, compartimentos abiertos y accesorios, también personalizados con grabados y moliendas de diseño.

Зеркала

Система Over включает в себя различные типы зеркал с обработанным краем и алюминиевым каркасом, которые могут дополнительно комплектоваться полочками, открытыми навесными элементами или другими аксессуарами, а также индивидуализируемые гравировкой или дизайнерским рисунком.





Illuminazione

Gli specchi hanno varie soluzioni di illuminazione. Con fascia Led incorporata nella superficie dello specchio, con retroilluminazione o con lampade orientabili e posizionabili liberamente.

Lighting

The mirrors have different lighting solutions. With built-in LED strip in the mirror surface, with backlighting or adjustable lamps that can be positioned freely.

Luces

Los espejos tienen diferentes soluciones de iluminación. Con banda LED incorporada en la superficie del espejo, con retroiluminación o con lámparas ajustables que se pueden colocar libremente.

Освещение

Зеркала имеют различные решения для дополнительного освещения. Встроенная в структуру зеркала светодиодная подсветка, задняя подсветка периметра или поворотные навесные светильники, размещаемые свободно.





A sinistra,
composizione
con base a
terra che può
contenere una
lavatrice.

On the left, a
composition with a
base unit that may
contain a washing
machine.

A la izquierda,
una composición
con un bajo que
puede contener una
lavadora.

Слева композиция
с напольной базой
для стиральной
машины.



Paris *je t'aime*

Nell'appartamento borghese si respira il senso piacevole della memoria, giusto un filo di romantica nostalgia. L'atmosfera confortevolmente chic si prolunga nel bagno, oasi di relax e 'bien vivre'.

In the bourgeois apartment you can breathe the pleasant sense of memory, with a little bit of romantic nostalgia. The comfortably chic atmosphere extends into the bathroom, an oasis of relax and 'bien vivre'.

En el apartamento burgués se puede respirar el agradable sentido de la memoria, con un poco de nostalgia romántica. El ambiente cómodo y elegante se extiende hasta el baño, un oasis de relax y 'bien vivre'.

Квартира в палаццо боргезе с неповторимым духом истории в каждом предмете, с легкими оттенками романтической ностальгии. Шикарная комфортная атмосфера распространяется и на ванную комнату, оазис релакса и 'bien vivre'.





Paris,
je t'aime



«Bonjour, ma chérie !»



Lo specchio acquista un'eleganza insolita con la molatura design.



The mirror acquires unusual elegance thanks to the design grinding.

El espejo adquiere una elegancia inusual gracias a la molienda de diseño.

Зеркало становится особенно элегантным с нанесенным дизайнерским рисунком.





* THIS IS JUST
A TRIBUTE TO
THE GREATEST
WALL ART
IN THE WORLD



Dal balcone della camera l'occhio cerca la Tour Eiffel

From the balcony of the room
the eye seeks the Eiffel Tower

Desde el balcón de la habitación
el ojo busca la Torre Eiffel

С балкона комнаты
открывается вид на
Эйфелеву башню.











Lavabi semi-incasso

Una nuova proposta, elegante ed essenziale nelle forme rigorose ma con un tocco di morbidezza, per i lavabi semi-incassati in Ceramilux.



Semi-recessed washbasins

A new proposal, elegant and essential in the strict forms, but with a touch of softness, for the semi-recessed washbasins in Ceramilux.

Lavabos semi-empotrados

Una nueva propuesta, elegante y esencial en las formas estrictas, pero con un toque de suavidad, para los lavabos semi-empotrados en Ceramilux.

Полувстроенные раковины

Новое предложение, элегантное и значимое в своих строгих формах, с шелковистым эффектом отделки поверхности - полувстроенные раковины из Ceramilux.



Lavabi in appoggio

La forma squadrata del lavabo in appoggio Quadro ricrea l'equilibrio degli opposti con la finitura scura del top mensola.

Sit-on washbasins

The square shape of the Quadro sit-on washbasin recreates the balance of opposites with the dark finish of the top console.

Lavabos de apoyo

La forma cuadrada del lavabo en apoyo Quadro recrea el equilibrio de los opuestos con la parte superior en acabado oscuro de la encimera.

Накладные раковины

Квадратная форма накладной раковины Quadro эффектна в сбалансированной композиции мебели с темной отделкой столешницы.









Tailormade design

Over è un sistema Tailormade Stocco personalizzabile su misura, realizzato con materiali ricercati e tecnologici, dal design riconoscibile.

Over is a Tailormade Stocco system, customizable on measure, made with materials and technology, with a recognizable design.

Over es un sistema Tailormade Stocco, adaptable a medida, hecho con materiales y tecnologías, con diseño reconocible.

Over - это система мебели Tailormade Stocco, персонализируемая по размеру, реализуемая в узнаваемом дизайне из современных технологичных материалов.

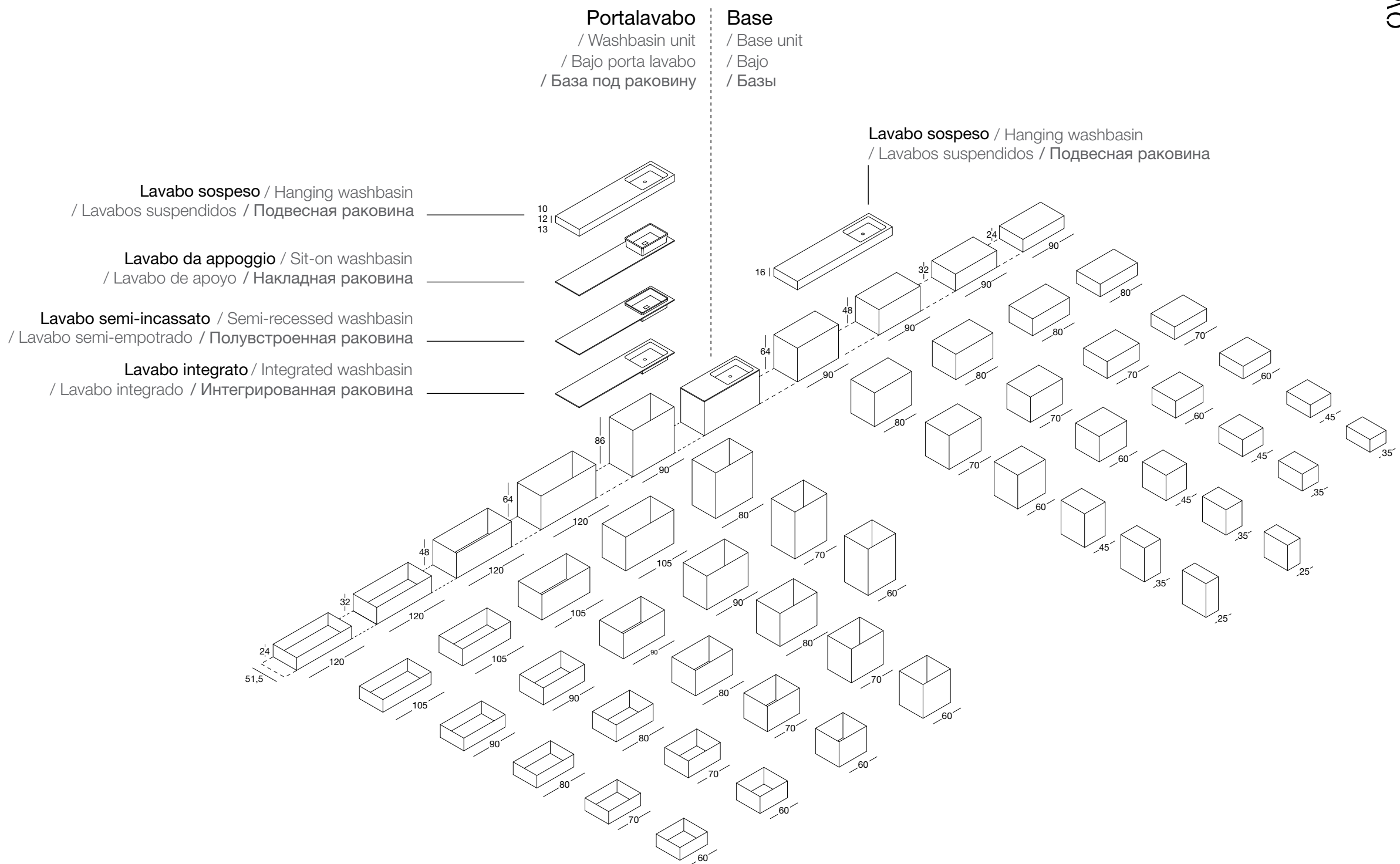

Apertura / Opening / Apertura / Открывание

Premi-apri
/ Push-Pull
/ Push-Pull
/ Открывание нажатием

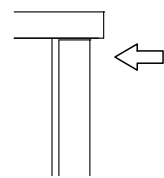

Gola
/ Groove opening
/ Apertura a gola
/ Врезная ручка

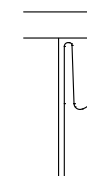

Maniglia
/ Handle
/ Tirador
/ Ручка

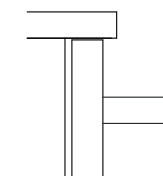

Top mensole

/ Top consoles / Encimeras lavabo / Полки-столешницы

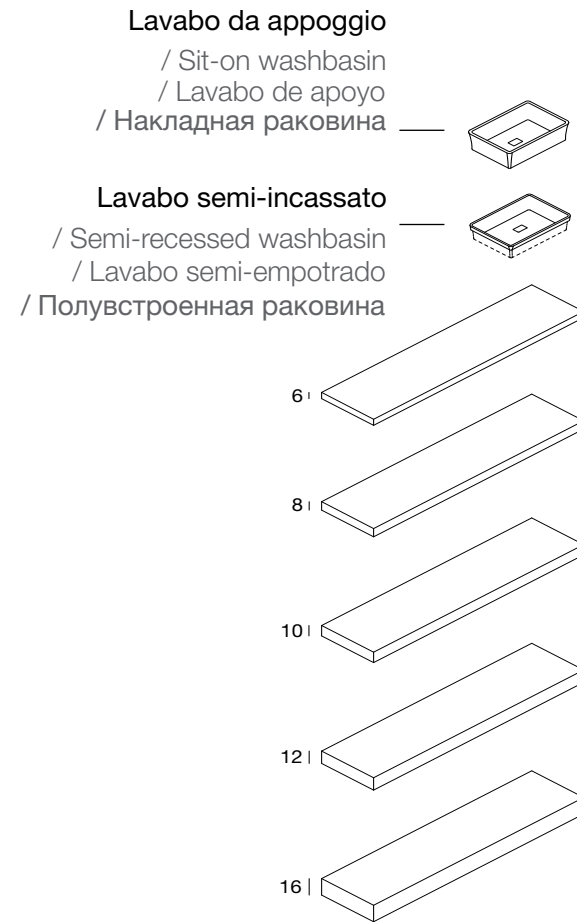

Pensili e colonne

/ Hanging units and columns
/ Armarios suspendidos y columnas
/ Шкафчики и колонны

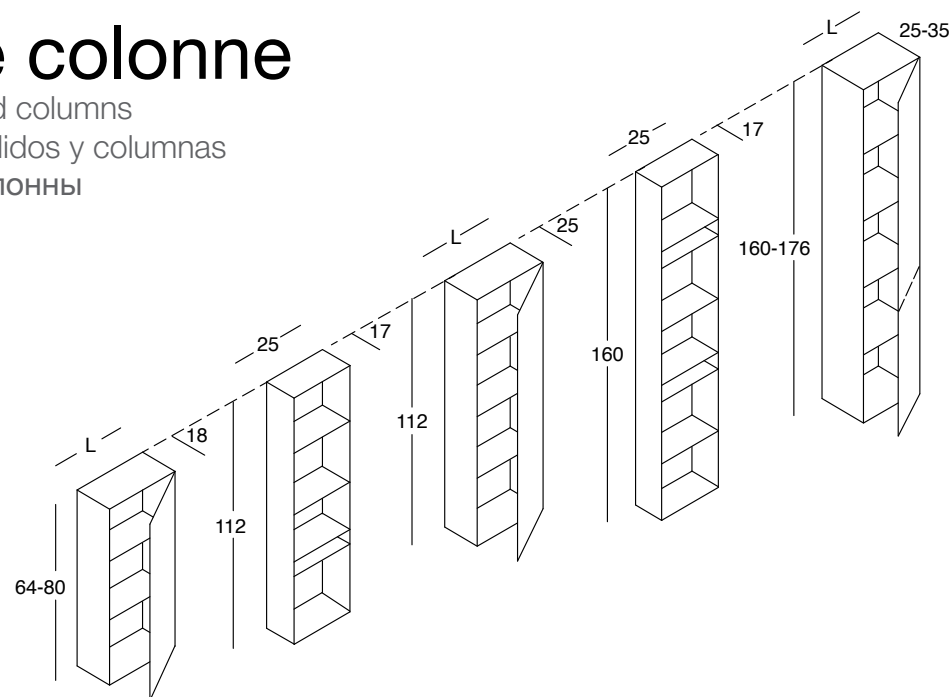

Gola design

I mobili contenitori Gola Design, abbinabili ai top mensole Over, possono essere sospesi o utilizzati in appoggio a terra, anche al centro stanza.

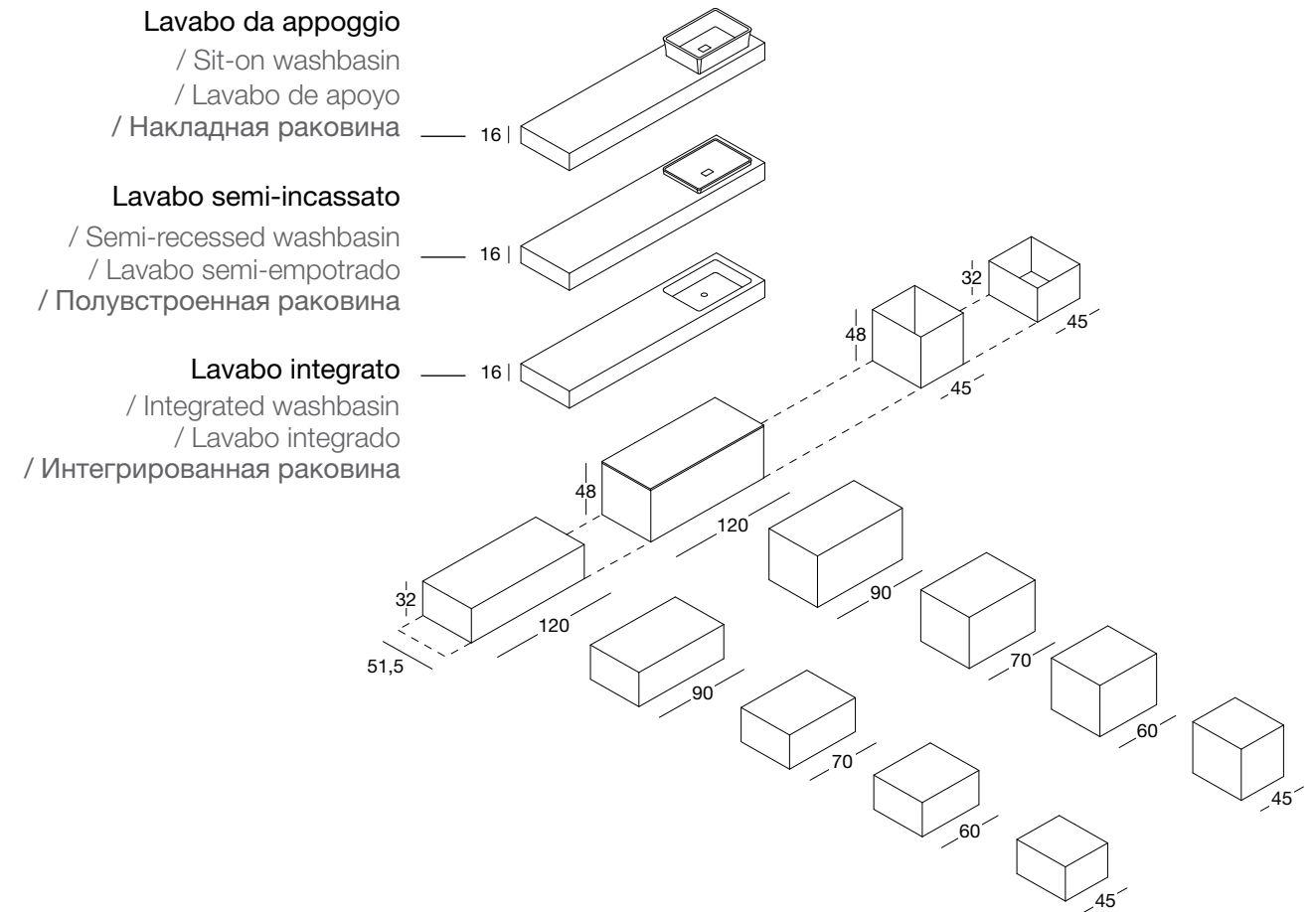

The Gola Design furniture, matching with the Over top consoles can be suspended or standing, even in the center of the room.

El mobiliario Gola Design, combinable con las encimeras lavabos Over, puede ser suspendido o al suelo, incluso en el centro de la sala.

Базы-контейнеры Gola Design, совмещающиеся с полками-столешницами Over, могут быть подвесными или использоваться в напольном варианте, в том числе как отдельностоящая мебель.

Apertura / Opening / Apertura / Открывание

Gola Design

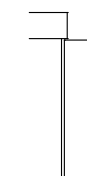

Tailormade design

Lavabi

/ Washbasins / Lavabos / Раковины

Lavabi da appoggio / Sit-on washbasins / Lavabos de apoyo / Накладные раковины

Lavabi da appoggio semi-incassati / Semi-recessed sit-on washbasins / Lavabos de apoyo semi-empotrados / Накладные полувстроенные раковины

Lavabi da appoggio e lavabi da appoggi semi-incassati - Ceramilux®

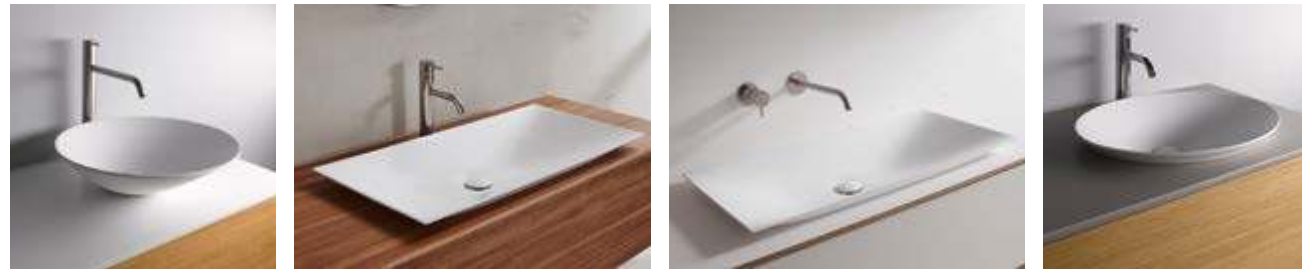

Lavabi da appoggio - Mineralmarmo®



QUADRO

Lavabi da appoggio - Mineralmarmo®



Lavabi da appoggio semi-incassati

Mineralmarmo®



BRIO

Lavabi da appoggio - Mineralmarmo®



Lavabi da appoggio semi-incassati - Mineralmarmo®



Top con lavabo integrato / Top with integrated washbasin / Encimera con lavabo integrado

/ Столешница с интегрированной раковиной

Mineralmarmo®



Corian®



Kerlite® - Laminam®



Vetro



Ceramica



Fenix®



Polaris



HPL



Specchi

/ Mirrors / Espejos / Зеркала

Specchi luminosi / Lighted mirrors / Espejos luminosos / Зеркала с подсветкой

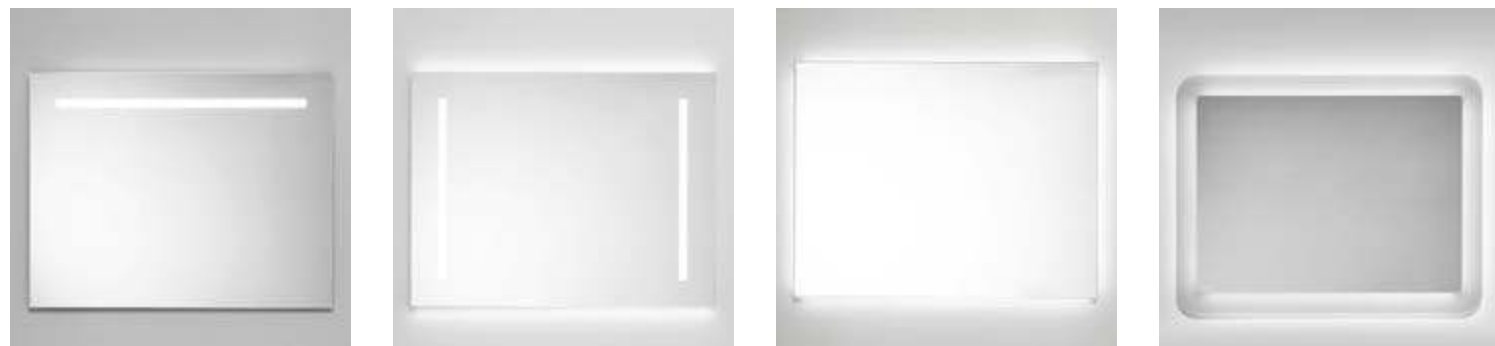

Specchi design / Design mirrors / Espejos de diseño / Дизайнерские зеркала



Filo lucido / Finished edge mirrors / Espejos con borde acabado brillante / Зеркала с обработанной кромкой



Myr



Lampade / Lamps / Lámparas / Светильники



OVER si completa con

/ Over is completed with / Over se completa con / Over комплектуется с

OVER

Per vedere la gamma completa dei prodotti, consultare il listino generale Tailormade Stocco.

For the full range of products, see the general price list Tailormade Stocco.

Para la gama completa de productos, vea la lista general de precios Tailormade Stocco.

Полная гамма продукции и информация по ней представлена в генеральном прайс-листе Tailormade Stocco

Cassetti / Drawers / Cajónes / Ящики



Base basket / Basket base unit / Base Basket / Базы basket



Vano a giorno / Open compartment / Compartimiento abierto / Открытая полка



Pensili e colonne / Hanging units and columns / Armarios suspendidos y columnas / Шкафчики и колонны



Materiali e finiture

/ Materials and finishes / Materiales y acabados / Материалы и отделки

Colori laccati / Laquered colors / Colores lacados / Окрашенные цвета



HST

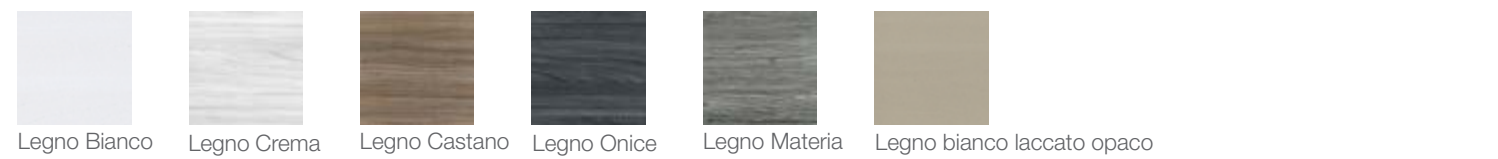

HPL



Kerlite®



Laminam®



Polaris

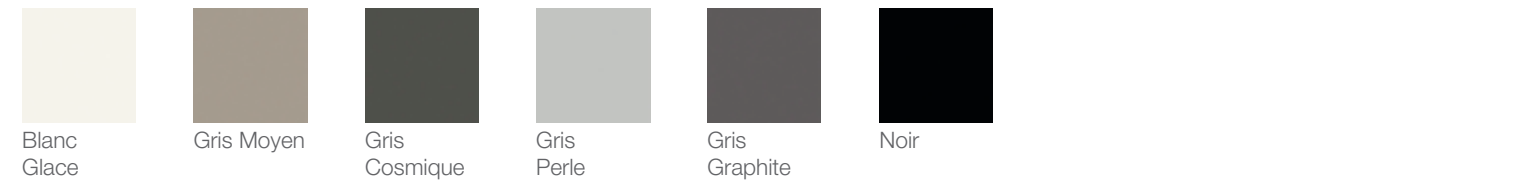

Legni

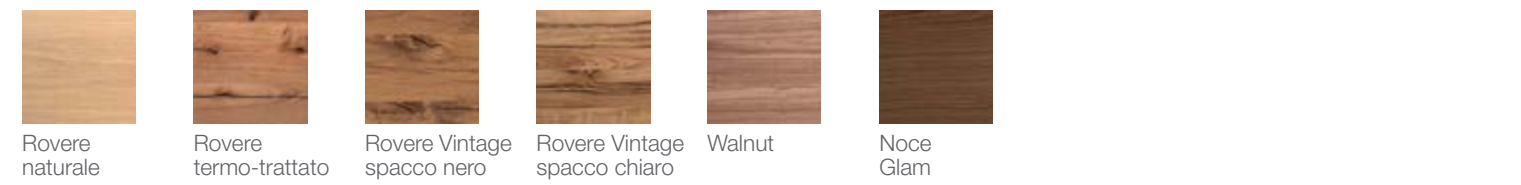

Fenix®



Vetro



Mineralmarmo®



Ceramilux®



Corian®

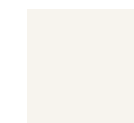

Cristalplant®

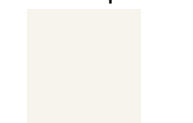

Per la gamma completa delle finiture consultare la Tavola Colori Tailormade Stocco. Le immagini rappresentate sono da considerarsi esempi indicativi e non vincolanti delle finiture proposte.

For the full range of finishes see the Tailormade Stocco color table. The represented images have to be considered as non-binding examples of the available finishings.

Para la gama completa de acabados, vea la tabla de colores Tailormade Stocco. Las imágenes representadas tienen que ser consideradas como ejemplos no vinculantes de los acabados disponibles.

Полная гамма цветов отделок представлена в Палитре Цветов Tailormade Stocco. Изображения цветов отделок могут отличаться от показанных на образцах, и поэтому не могут являться определяющими при выборе отделки.

Tailormade design

Sommario

/ Summary / Sumario / Содержание

Top / Top / Encimera / Столешница
Lavabo / Washbasin / Lavabo / Раковина
Mobile / Furniture / Mueble / Мебель
Specchio / Mirror / Espejo / Зеркало
Luci / Lighting / Luces / Свет
Vasca / Bathtub / Bañera / Ванна
Piatto doccia / Shower tray / Plato de ducha / Душевой поддон
Pensile / Hanging unit / Armario suspendido / Шкафчик
Colonna / Column / Columna / Колонна
Mensolone / Top consoles / Encimeras lavabo / Столешницы-полки

Dimensioni L P H cm / Sizes / Tamaños / Размеры

Manhattan skyline



Pag. 10-11
Over 1
Top HPL Olmo B534 L 320 P 51,5 H 6
Mobile Grigio Grafite O 198
L 320 P 51 H 32
Specchio L 60/180/60 H 70
Vasca Origami MMO L 210 P 110 H 52



Pag. 18-19
Eklò Interno gres porcellanato colore Ice Gesso, esterno vasca Luci di Venezia Blue
/ Interior in porcelain gres, color Ice Gesso, exterior of the basin in Luci di Venezia Blue
/ Interior en gres de porcelana, color Ice Gesso, exterior de el lavabo en Luci di Venezia Blue
/ Внутри керамогранит цвета Ice Gesso, внешность резервуара Luci di Venezia Blue
L 80 P 38 H 87,5
Vasca Origami CP L 280 P 105 H 53



Pag. 28-29
Over 2
Top Corian L 270 P 51,5 H 16
Mobile: Grigio Grafite B 104
L 225 P 51 H 16
Specchio L 70 H 105
Vasca Origami Corian
L 180 P 100 H 55
Piatto doccia Corian L 250 P 100 H 30
Colonna Bianco O 20 a giorno
L 25 H 160 P 17
Colonna Grigio Grafite B 104
L 35 H 160 P 25



Pag. 32
Over 3
Top PF Blanc Glace L 150 P 51,5 H 6
Mobile Cemento O 196, Walnut WN,
Nero O 46 L 150 P 51 H 32
Specchio L 150 H 64
Luce BL013



Pag. 34
Over 4
Top HPL Carrara Vecchio
L 135 P 51,5 H 6
Mobile Cemento O 196, Peonia O 69 L
135 P 51 H 32
Specchio L 135 H 64
Luce BL013



Pag. 36
Over 5
Top PF Noir L 135 P 51,5 H 6
Mobile Bianco O 20, Rovere RN
L 135 P 51 H 32
Specchio L 135 H 64



Pag. 37
Over 6
Top PF Gris Graphite L 140 P 51,5 H 6
Mobile Cemento O 196, Walnut WN
L 140 P 51 H 48
Specchio L 150 H 64
Luce BL013



Pag. 38
Over 7
Top PF Blanc Glace L 185 P 51,5 H 6
Mobile Nero O 46, Walnut WN,
Lemon O 128 L 185 P 51 H 32
Specchio L 64 H 70
Luce BL49P



Pag. 39
Over 8
Top PF Blanc Glace L 140 P 51,5 H 6
Mobile Corda B 173 L 140 P 51 H 32
Specchio Frame L 140 H 70



Pag. 40
Over 9
Top PF Gris Perle L 165 P 51,5 H 6
Mobile Lino O 172, Cielo O 162
L 165 P 51 H 32
Specchio Spline L 84 H 94



Pag. 41
Over 10
Top PF Noir L 165 P 51,5 H 6
Mobile Cemento O 196, Peonia O 69
L 165 P 51 H 32



Pag. 44-45
Over 11
Top PF Blanc Glace
L 260 P 51,5 H 12
Mobile Lino O 172 L 225 P 51 H 54
Specchio L 230 H 64
Vasca Origami MMO L 170 P 80 H 50
Piatto doccia Origami MO
L 200 P 100 H 30



Pag. 51
Over 12
Top Rovere Termo-trattato W5
L 112 P 45 H 10
Lavabo Ceramilux BE395
Specchio Charm L 70



Pag. 54-55
Over 13
Top Vetro Gray Brown VX 208
L 180 P 51,5 H 1
Lavabo MMO BE383
Mobile Gray Brown 131
L 180 P 51 H 48
Specchio Frame L 140 H 70
Vasca Origami MMO L 170 P 80 H 50



Pag. 60
Over 17
Top Corian L 160 P 51,5 H 1,2
Mobile Nero B 100 L 160 P 51 H 32
Specchio Frame L 70 H 90



Pag. 61
Over 18
Top PF Gris Moyen L 125 P 51,5 H 2
Mobile Creta B 74 L 125 P 51 H 32
Specchio L 125 H 64



Pag. 62
Over 19
Top MMO Wave L 155 P 51,5 H 1,5
Mobile Rosso Bordeaux O 36
L 155 P 51 H 32
Mensolone HPL Portland B508
L 155 P 510 H 10
Specchio L 35 H 120



Pag. 63
Over 20
Top Corian L 150 P 51,5 H 6
Mobile Lemon O 128 Walnut WN
L 150 P 51 H 32
Specchio L 105 H 64
Luce BL013



Pag. 63
Over 21
Top Corian L 215 P 51,5 H 1,5
Mobile Cielo O 200 Lino O 175
L 215 P 51 H 32
Specchio L 90 H 70



Pag. 64
Over 22
Top MML Big L 180 P 51,5 H 1,5
Mobile Creta O 73
L 180 P 51 H 48/89
Specchio Contenitore / Mirror cabinet
/ Armario con espejo
/ Зеркало-контейнер
L 90 H 70 P 14



Pag. 56
Over 14
Top Corian L 180 P 51,5 H 1,2
Mobile Cappuccino B 163
L 180 P 51 H 48
Specchio L 180 H 64
Luce BL46P



Pag. 58
Over 15
Top MMO Wave L 135 P 51,5 H 1,5
Mobile HST K11 Legno Crema
L 135 P 51 H 48
Specchio L 125 H 70
Vasca Origami MMO L 170 P 80 H 50



Pag. 59
Over 16
Top MO L 180 P 51,5 H 1,5
Mobile Blu Oltremare O 190
L 180 P 51 H 24/48
Specchio L 120 H 70



Pag. 65
Over 23
Top MO L 165 P 51,5 H 6
Mobile Rubino O 65 L 165 P 51 H 32
Specchio L 160 H 70



Pag. 70
Over 24
Top MMO Big L 165 P 51,5 H 1,5
Mobile Nero B 100 L 165 P 51 H 48
Specchio Frame L 160 H 70
Vasca Origami CP L 184 P 83 H 51



Pag. 76-77
Over 25
Top Walnut WN L 190 P 51 H 12
Lavabo Ceramilux BE398
Mobile Cemento O 196
L 180 P 51 H 54
Specchio Crown L 85
Vasca Origami MMO L 170 P 80 H 50
Pensile Vetro / Glass / Vidrio / Стекло
L 64/28 H 28 P 20



Pag. 80-81
Over 26
Top HPL Carrara Vecchio
L 240 P 51,5 H 6
Lavabo Ceramilux BE395
Mobile Ferro B 197 L 270 P 51 H 32
Specchio L 70/160 H 70
Vasca Origami MMO L 170 P 80 H 50



Pag. 89
Over 30
Top HPL Rovere Tabacco B501
L 180 P 51,5 H 10
Lavabo MML BE388
Mobile Bianco B 21 L 180 P 51 H 32
Specchio L 90 H 70



Pag. 90
Over 31
Top HPL Dax Stone B539
L 120 P 51,5 H 6
Lavabo Ceramilux BE395
Mobile Giada O 71 L 120 P 51 H 32
Specchio Charm L 80



Pag. 91
Over 32
Top Corian L 210 P 51,5 H 1,2
Lavabi Ceramilux BE395
Mobile Nero O 46 L 210 P 51 H 32
Specchio L 35 H 110



Pag. 92
Over 33
Top Rovere RN L 175 P 51,5 H 10
Lavabo MML BE347
Mobile Melanzana B 110
L 175 P 51 H 32
Specchio L 64 H 120



Pag. 93
Over 34
Top HPL Ossido B546
L 160 P 51,5 H 12
Lavabo MMO BE388
Mobile Avana O 180 L 180 P 51 H 54
Specchio L 160 H 70
Pensile Bianco O 20 L 112 H 25 P 17



Pag. 94
Over 35
Top Rovere RN L 220 P 51,5 H 10
Lavabo MML BE347
Specchio L 160 H 64
Luci BL49P



Pag. 84
Over 27
Top Rovere naturale RN
L 180 P 51,5 H 10
Lavabo Ceramilux BE395
Mobile Grigio Grafite B 104
L 180 P 51 H 32
Specchio Frame L 180 H 70



Pag. 86
Over 28
Top HPL Travertino
L 180 P 51,5 H 6
Lavabi Ceramilux BE397
Mobile Rubino O 65 L 180 P 51 H 32
Specchio Frame L 180 H 70



Pag. 88
Over 29
Top Hpl Fossile B500
L 210 P 51,5 H 6
Lavabo MML BE391
Mobile Grigio Chiaro B 148
L 210 P 51 H 32
Specchio L 64 H 105
Pensile a giorno / Open hanging unit
/ Armario suspendido abierto / Открытый
шкафчик RN L 50 H 20 P 18



Pag. 94
Over 36
Mobile Bianco O 20 L 140 P 51 H 54



Pag. 95
Over 37
Top Rovere Termo-Trattato W5
L 140 P 51,5 H 12
Lavabo MML BE388
Mobile Avana O 180 L 180 P 51 H 54
Specchio Spline L 84 H 94

Tailormade Stocco Collections

all rights reserved Community Design

Graphic Design

Stocco LAB

Product Design

R&D Stocco

AD/Copy

Lorenza Prandina

Printing

Grafiche Antiga

Mineralmarmo®, Ceramilux®, Corian®, Cristalplant®, Kerlite®, Fenix®, Laminam® sono marchi registrati di proprietà dei loro rispettivi titolari.

Mineralmarmo®, Ceramilux®, Corian®, Cristalplant®, Kerlite®, Fenix®, Laminam® are registered trademarks owned by their respective owners.

Mineralmarmo®, Ceramilux®, Corian®, Cristalplant®, Kerlite®, Fenix®, Laminam® son marcas registradas propiedad de sus respectivos propietarios.

Mineralmarmo®, Ceramilux®, Corian®, Cristalplant®, Kerlite®, Fenix®, Laminam® являются зарегистрированными товарными знаками с правами собственности.

TAILORMADE
STOCCO

OVER_01/2017_01_IT - EN - ES - RU_Printed in Italy

F.lli Stocco srl ha facoltà di apportare ai prodotti tutte le modifiche, migliorie tecniche ed annullamenti di articoli di fine serie che siano ritenuti opportuni, in qualsiasi momento, senza alcun preavviso.

F.lli Stocco srl è azienda certificata per il sistema qualità ISO9001 e OHSAS18001.

F.lli Stocco srl reserves the right to introduce changes, technical improvements and cancellations of not available articles, that are considered necessary, at any time, without any prior notification. F.lli Stocco srl is certified to the ISO9001 and OHSAS18001 quality system.

F.lli Stocco srl se reserva el derecho de introducir cambios, mejoras técnicas y cancelaciones de artículos no disponibles, que se consideren necesarias, en cualquier momento y sin previo aviso.

F.lli Stocco srl está certificada con el sistema de calidad ISO9001 y OHSAS18001.

F.lli Stocco srl оставляет за собой право вносить изменения в свою продукцию, улучшать ее технические характеристики, а также аннулировать артикулы серий, снятых с производства - по своему усмотрению, в любое время и без особых уведомлений. Компания F.lli Stocco srl сертифицирована в системах качества ISO9001 и OHSAS18001.

F.lli STOCCO srl

Via Valsugana, 318/A
35010 - S. Giorgio in Bosco (Padova) Italy
tel. +39 049 9453911
fax +39 049 9450218
commerciale@stocco.it
www.stocco.it



TAILORMADE
STOCCO

F.lli STOCCO srl
Via Valsugana, 318/A
35010 - S. Giorgio in Bosco (Padova) Italy
tel. +39 049 9453911
fax +39 049 9450218
commerciale@stocco.it
www.stocco.it