

ARGILLA



ARGILLA



ARGILLA

Argilla è una nuova storia da raccontare nel settore dell'interior design; offre ad architetti e professionisti una nuova ampia gamma di formati in gres porcellanato e nuove forme geometriche decorative. Un nuovo orizzonte per il rivestimento di pavimenti e pareti in gres, per gli amanti dei decori e di superfici capaci di raccontare una tradizione.

Questa nuova collezione si presenta in 6 nuovi colori di Argilla che si strutturano in 6 formati, 3 mosaici, 2 superfici e 2 diversi spessori; un sistema pensato per pavimentare e rivestire spazi sia residenziali che commerciali.

PENTAGON BIG ARGILLA

ARGILLA **BIACCA - FOG - DRY**
MATERIAL \neq 4,8 mm



MATERIAL ≠ 4,8 mm

QUARTZ ≠ 12 mm

COLORI ARGILLA

MATERIAL \neq 4,8 mm

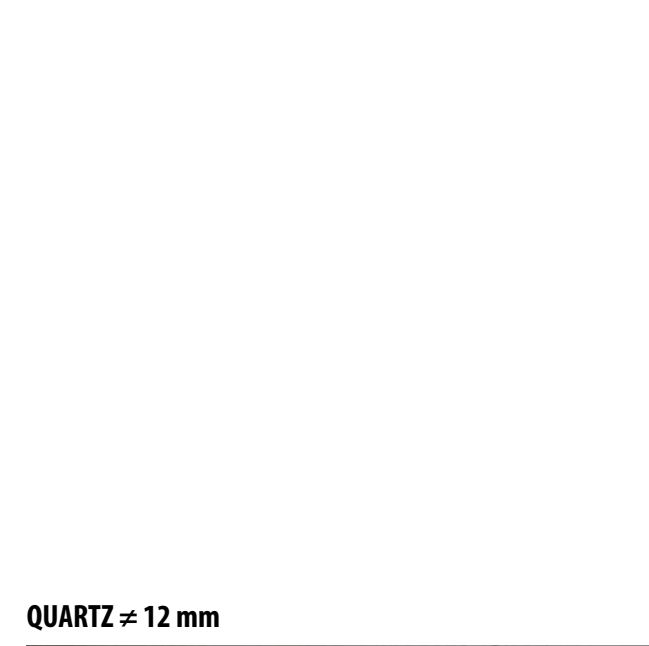

QUARTZ \neq 12 mm

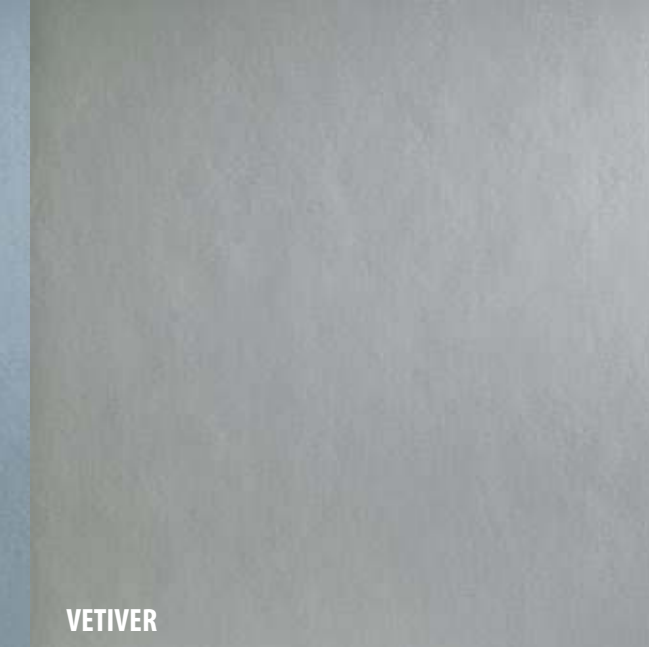

DARK

WALL **DARK** MATERIAL ≈ 4,8 mm
FLOOR **DARK** QUARTZ ≈ 12 mm





DARK





DRY

WALL **DRY** MATERIAL ≠ 4,8 mm
FLOOR **DRY** QUARTZ ≠ 12 mm

BIACCA



WALL **BIACCA** MATERIAL \neq 4,8 mm
FLOOR **BIACCA** QUARTZ \neq 12 mm





FOG



FOG MATERIAL ≈ 4,8 mm



MARINE

WALL **MARINE** MATERIAL ≈ 4,8 mm
FLOOR **MARINE** QUARTZ ≈ 12 mm





VETIVER

WALL **VETIVER** MATERIAL \approx 4,8 mm
FLOOR **VETIVER** QUARTZ \approx 12 mm



BIACCA

BIACCA PENTAGON LARGE QUARTZ 12 mm



MARINE

MARINE PENTAGON SMALL MATERIAL ≈ 4,8 mm



GAMMA ARGILLA

6

COLORI
COLOURS
ЦВЕТОВ

Bianca
Fog
Dark
Dry
Marine
Vetiver

7

FORMATI
SHAPES
ФОРМАТОВ

120x120*
40x120*
60x120*
60x60*
15x15*
Pentagon Large
Pentagon Small

2

SUPERFICI
SURFACES
ПОВЕРХНОСТИ

Material \approx 4,8 mm
Quartz \approx 12 mm

2

SPESSORI
THICKNESS
ТОЛЩИНЫ

Material \approx 4,8 mm
Quartz \approx 12 mm

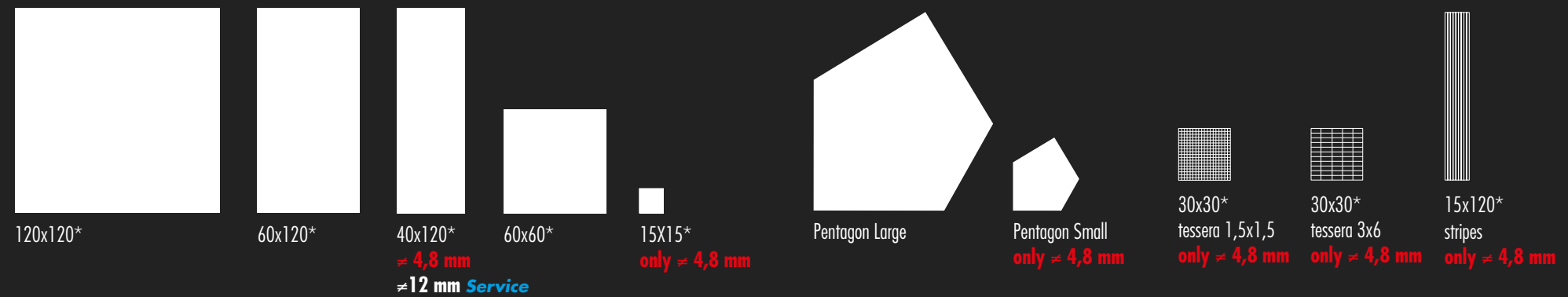

MATERIAL only \approx 4,8 mm



La superficie **Material** è opaca e al tatto presenta un lieve rilievo che ricorda un intonaco irregolare. Nello spessore sottile di 4,8 mm, è ideale per ottenere vibranti rivestimenti e pavimenti. The **Material** surface is matte and reveals to the touch a slight relief, reminiscent of unfinished gypsum. Available in 4.8 mm thickness, it is ideal for floorings and vibrant coverings. Поверхность **Material** является непрозрачной и имеет небольшой рельеф, напоминающий неровную штукатурку. С толщиной 4,8 мм, она идеальна для реализации напольных и настенных покрытий.

QUARTZ only \approx 12 mm



La superficie **Quartz** presenta una lucidatura molto naturale che ricorda i marmi o i cementi levigati al quarzo. Disponibile nello spessore di 12 mm, è ideale per resistenti ed eleganti pavimentazioni di ambienti commerciali e residenziali. The **Quartz** surface has a very natural brushed look, reminiscent of buffed quartz cement. Available in 12 mm thickness, it is ideal for durable elegant floorings in both commercial and residential spaces. С поверхностью **Quartz** получается эффект естественной полировки, напоминающей мрамор или полированный бетон. Доступна в толщине 12 мм, поверхность **Quartz** идеальна для прочных и элегантных напольных покрытий коммерческих или жилых помещений.

PEZZI SPECIALI TRIM PIECES СПЕЦИАЛЬНЫЕ ИЗДЕЛИЯ

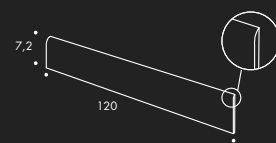

Battiscopa
Skirting
Плинтус

120x7,2* \approx 4,8 mm Material

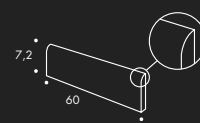

Battiscopa
Skirting
Плинтус

60x7,2* \approx 12 mm Quartz



Elemento a L
V-Cap

60x16,5x4,2* \approx 12 mm

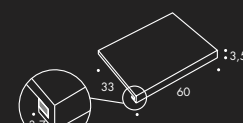

Gradino costa retta 60
Costa retta step 60
Ступень с прямой кромкой 60

60x33x3,5x3,7* \approx 12 mm Quartz

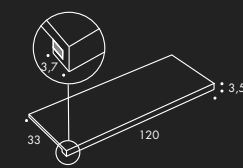

Gradino costa retta 120
Costa retta step 120C
тулень с прямой кромкой 120

120x33x3,5x3,7* \approx 12 mm Quartz

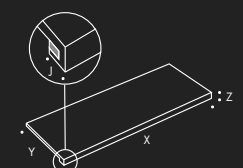

Gradino costa retta personalizzabile
Bespoke size costa retta step
Ступень с прямой кромкой, возможны индивидуальные размеры

XxYxZxJ* \approx 12 mm Quartz
Service



Margella
Elemento con zigzag

31x120x5* \approx 12 mm Quartz
Service



Gradino monolitico 120
Step 120 single piece
Ступень со сплошной поверхностью 120

31x120x19* \approx 12 mm Quartz



*Misure nominali
*Nominal sizes
*номинальные размеры

- Per ulteriori informazioni tecniche consultare il sito www.dsgceramiche.it
- For additional informations please visit our website www.dsgceramiche.it
- Дополнительную техническую информацию можно найти на сайте www.dsgceramiche.it

COLORI ARGILLA

MATERIAL only ≠ 4,8 mm



BIACCA



FOG



DARK



DRY

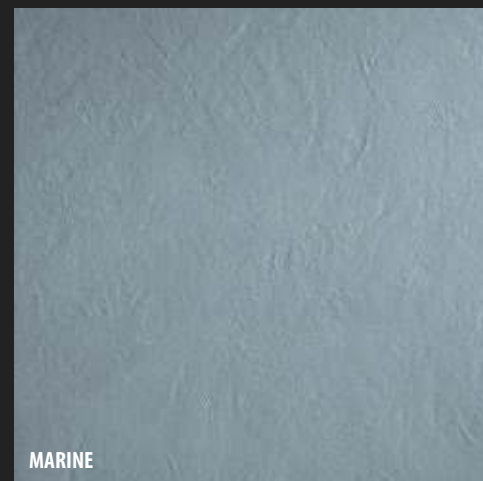

MARINE



VETIVER

QUARTZ only ≠ 12 mm



BIACCA

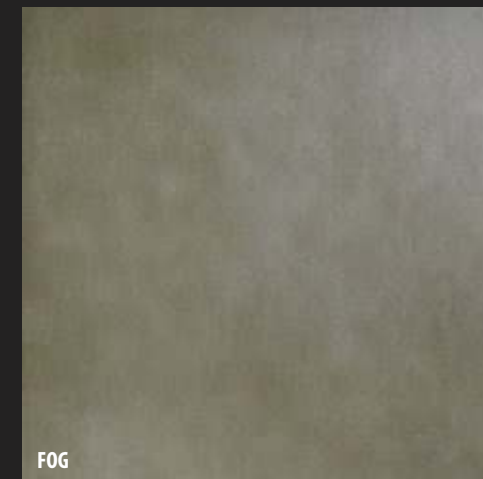

FOG



DARK



DRY

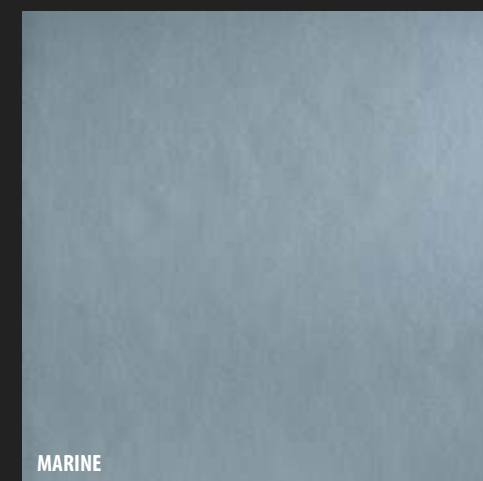

MARINE



VETIVER

PENTAGON ARGILLA

Pentagon Small

Material ≈ 4,8 mm

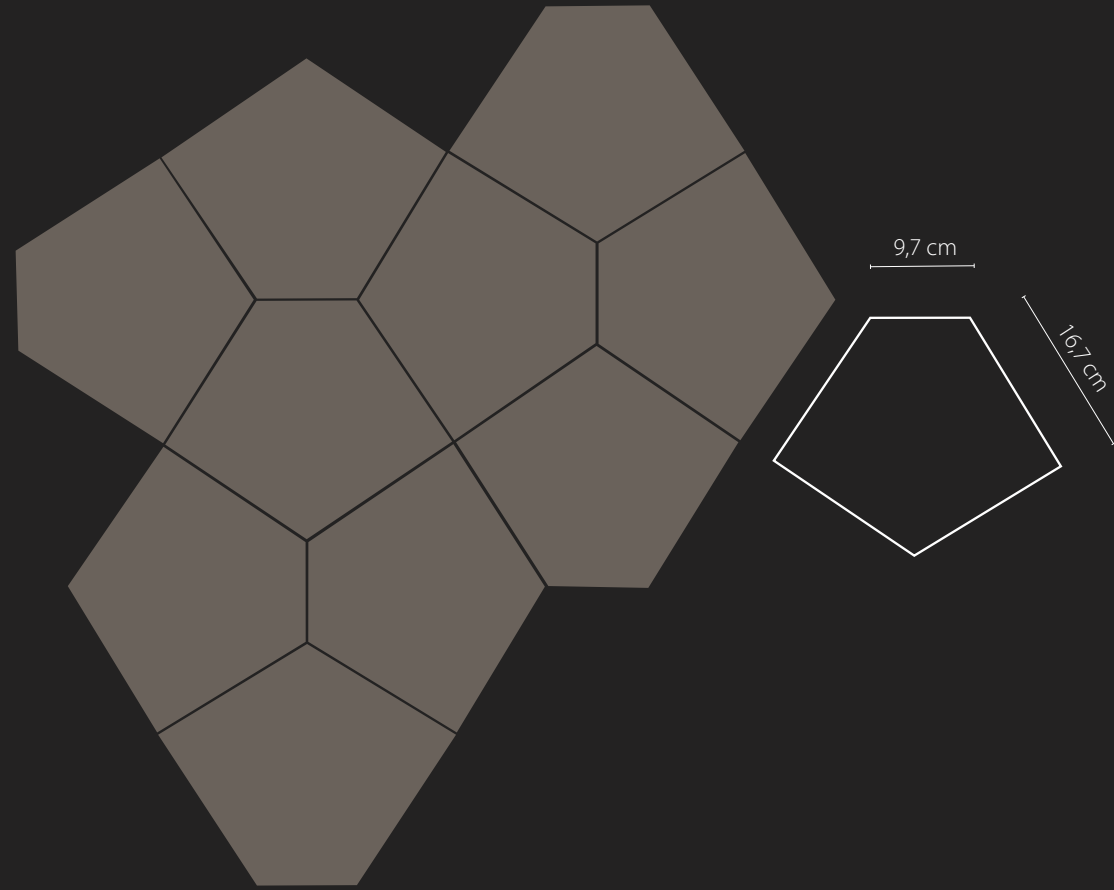

MATERIAL
only ≈ 4,8 mm



BIACCA FOG DARK DRY MARINE VETIVER

Pentagon Large

Material ≈ 4,8 mm

Quartz ≈ 12 mm

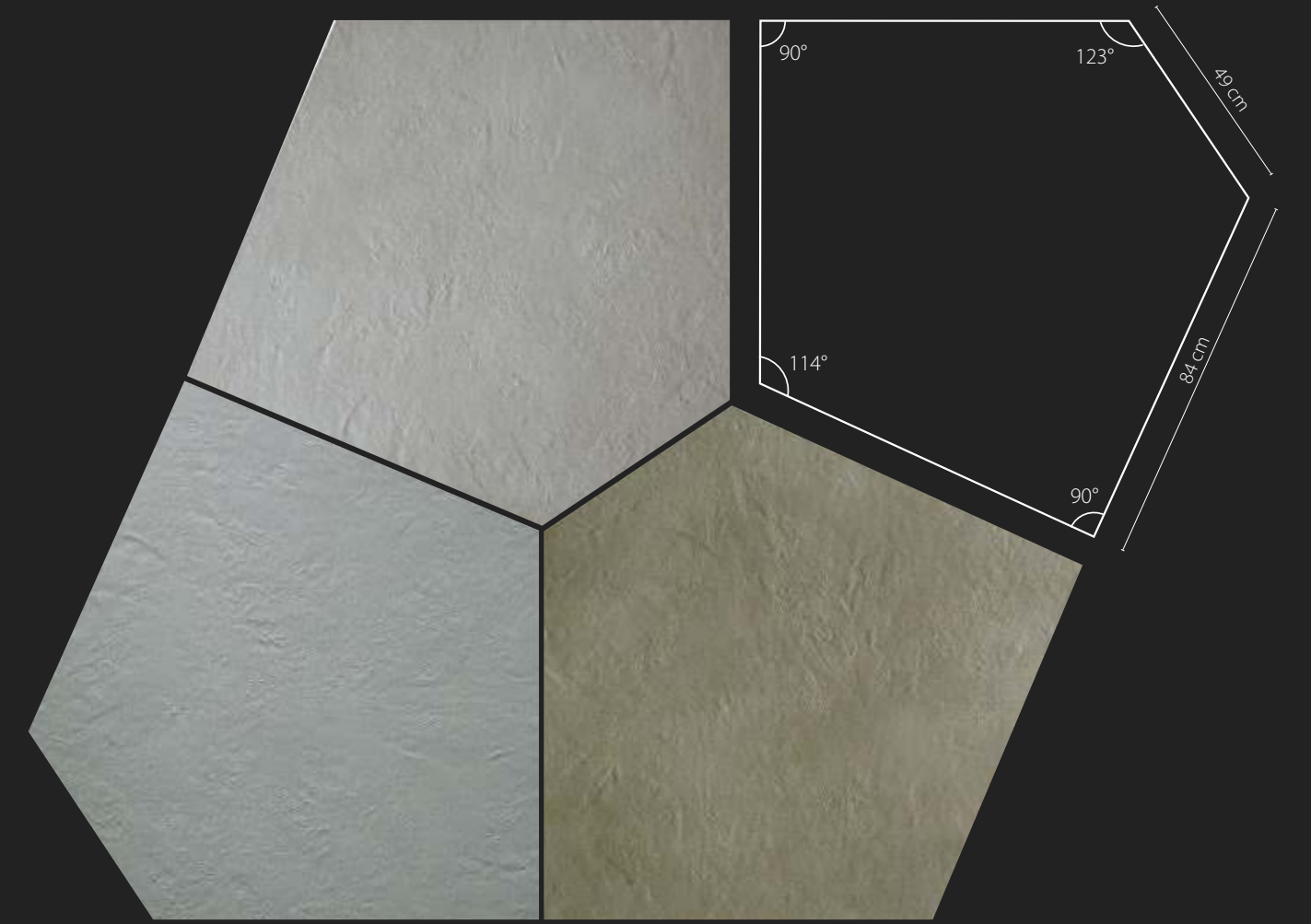

MATERIAL
only ≈ 4,8 mm



BIACCA FOG DARK DRY MARINE VETIVER

QUARTZ
only ≈ 12 mm



BIACCA FOG DARK DRY MARINE VETIVER



*Misure nominali
*Nominal sizes
*номинальные размеры

- Per ulteriori informazioni tecniche consultare il sito www.dsgceramiche.it
- For additional informations please visit our website www.dsgceramiche.it
- Дополнительную техническую информацию можно найти на сайте www.dsgceramiche.it

LAVABI EKO / WASHBASIN / РАКОВИНЫ

MATERIAL \approx 4,8 mm

EKO LARGE

EKO MEDIUM

EKO SMALL

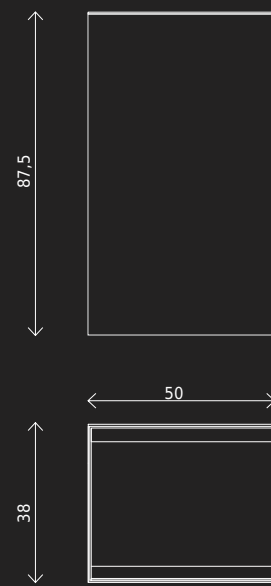
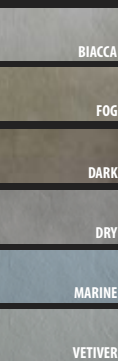

FREESTANDING

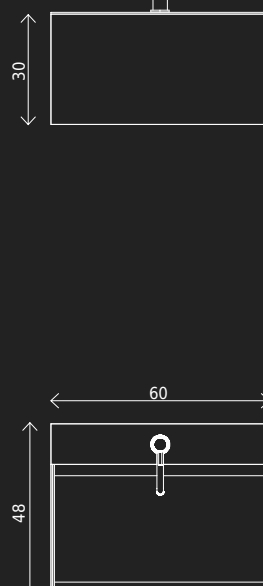

DA APPOGGIO O SOSPESO
TO BE MOUNTED ON STAND OR WALL HUNG
НАСТОЛЬНЫЙ ИЛИ ПОДВЕШЕННЫЙ

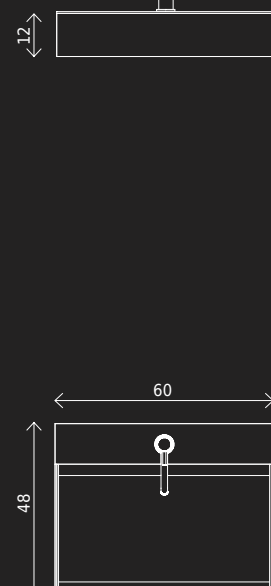

DA APPOGGIO O SOSPESO
TO BE MOUNTED ON STAND OR WALL HUNG
НАСТОЛЬНЫЙ ИЛИ ПОДВЕШЕННЫЙ

VASCA INTERNA / INNER SURFACE OF THE WASHBASIN / ВНУТРЕННЯЯ ПОВЕРХНОСТЬ УМЫВАЛЬНИКА
IN GRES PORCELLANATO COLLEZIONE LIGHT - GESSO / PORCELAIN GRES LIGHT - GESSO COLLECTION / КЕРАМОГРАНИТ ИЗ КОЛЛЕКЦИИ LIGHT - GESSO

ESTERNO VASCA / EXTERNAL WASHBASIN / НАРУЖНАЯ ПОВЕРХНОСТЬ УМЫВАЛЬНИКА
DISPONIBILE IN TUTTI I COLORI ARGILLA MATERIAL \approx 4,8 / AVAILABLE IN ALL ARGILLA MATERIAL COLOURS \approx 4,8 / ДОСТУПНАЯ ВО ВСЕХ ЦВЕТАХ ARGILLA MATERIAL ТОЛЩ. 4,8

PILETTA DI SERIE INCLUSA / WASTE STANDARD INCLUDED / СТАНДАРТНЫЙ СЛИВ ВХОДИТ В КОМПЛЕКТ ПОСТАВКИ

FORO MISCELATORE DI SERIE / WITH MIXER-TAP HOLE / ОТВЕРСТИЕ УМЫВАЛЬНИКА
SU RICHIESTA È POSSIBILE REALIZZARE IL LAVABO SENZA FORO MISCELATORE / WITHOUT MIXER-TAP HOLE ON REQUEST / ПО ЗАКАЗУ ПОСТАВЛЯЕТСЯ ТАКЖЕ БЕЗ ОТВЕРСТИЯ УМЫВАЛЬНИКА.

Service

INTERNO VASCA / INNER SURFACE OF THE WASHBASIN / ВНУТРЕННЯЯ ПОВЕРХНОСТЬ УМЫВАЛЬНИКА
DISPONIBILE IN TUTTE LE COLLEZIONI DSG IN \approx 4,8 / AVAILABLE IN ALL DSG COLLECTIONS \approx 4,8 / ДОСТУПНАЯ ВО ВСЕХ КОЛЛЕКЦИЯХ DSG ТОЛЩ. 4,8



ISPEZIONE LAVABO / INSPECTION WASHBASINS / ДОСТУП К УМЫВАЛЬНИКУ

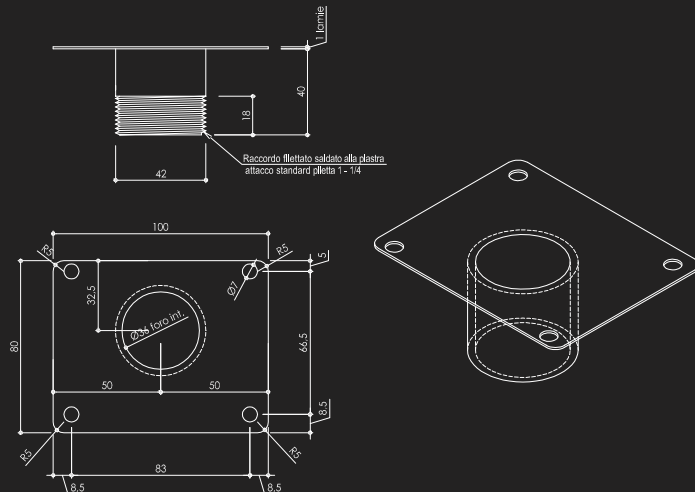

PILETTA DI SERIE INCLUSA / WASTE STANDARD INCLUDED / СТАНДАРТНЫЙ СЛИВ ВХОДИТ В КОМПЛЕКТ ПОСТАВКИ

CARATTERISTICHE TECNICHE / TECHNICAL SPECIFICATIONS / ТЕХНИЧЕСКИЕ ХАРАКТЕРИСТИКИ

Material \approx 4,8 mm

Quartz \approx 12 mm

LASTRE DI GRES PORCELLANATO - MULTISTRATO MULTILAYER PORCELAIN - ПЛИТЫ ИЗ МНОГОСЛОЙНОГО КЕРАМОГРАНИТА SLABS ISO 13006 - G - Bia UGL (E \leq 0,5%) UNI EN 14411 - G -

	CARATTERISTICHE TECNICHE TECHNICAL SPECIFICATIONS ТЕХНИЧЕСКИЕ ХАРАКТЕРИСТИКИ	NORMA ISO STANDARD	VALORI PRESCRITTI DALLE NORME INTERNATIONAL STANDARDS НОРМАТИВНЫЕ ЗНАЧЕНИЯ	VALORE MEDIO DSG-GIGACER AVERAGE DSG-GIGACER value СРЕДНЕЕ ЗНАЧЕНИЕ DSG-GIGACER
	CARATTERISTICHE DIMENSIONALI DIMENSIONAL CHARACTERISTICS РАЗМЕРНЫЕ ХАРАКТЕРИСТИКИ		S > 410	
	LATI SIDES СТОРОНЫ	ISO 10545-2	\pm 0,6%	\pm 0,2%
	SPESSORE THICKNESS ТОЛЩИНА		\pm 5%	\pm 3%
	RETTILINEITÀ DEGLI SPIGOLI STRAIGHTNESS OF EDGES ПРЯМОЛИНЕЙНОСТЬ КРОМОК		\pm 0,5%	\pm 0,2%
	ORTOGONALITÀ RECTANGULARITY ОРТОГОНАЛЬНОСТЬ		\pm 0,6%	\pm 0,2%
	PLANARITÀ SURFACE FLATNESS ПЛОСКОСТНОСТЬ		\pm 0,5%	\pm 0,2%
	ASSORBIMENTO D'ACQUA WATER ABSORPTION ПОГЛОЩЕНИЕ ВОДЫ	ISO 10545-3	\leq 0,5%	\leq 0,1%
	RESISTENZA ALLA FLESSIONE BENDING STRENGTH ПРОЧНОСТЬ НА ИЗГИБ	ISO 10545-4	\geq 35N/mm ²	\geq 40 N/mm ²
	MODULO DI ROTTURA MODULUS OF RUPTURE МОДУЛЬ РАЗРУШЕНИЯ	ISO 10545-4	MATERIAL: > 700N (sp. \leq 7,5mm) QUARTZ: > 1.300N (sp. \leq 7,5mm)	MATERIAL: > 700 N QUARTZ: > 4000 N
	RESISTENZA ALL'ABRASIONE PROFONDA RESISTANCE TO DEEP ABRASION СТОЙКОСТЬ К ГЛУБОКОМУ ИСТИРАНИЮ	ISO 10545-6	\leq 175mm ³	\leq 145 mm ³
	COEFFICIENTE DI DILATAZIONE TERMICA LINEARE COEFFICIENT OF LINEAR THERMAL EXPANSION КОЭФФИЦИЕНТ ЛИНЕЙНОГО ТЕПЛООВОГО РАСШИРЕНИЯ	ISO 10545-8	\leq 9X10 ⁻⁶ °c ⁻¹	\leq 7X10 ⁻⁶ °c ⁻¹
	RESISTENZA AGLI SBALZI TERMICI RESISTANCE TO THERMAL SHOCKS СТОЙКОСТЬ К ТЕПЛОВЫМ ПЕРЕПАДАМ	-	METODO DISPONIBILE AVAILABLE METHOD ДОСТУПНЫЙ МЕТОД	RESISTE RESISTANT СТОЙКАЯ
	RESISTENZA AL GELO FROST RESISTANCE МОРОЗОСТОЙКОСТЬ	ISO 10545-12	METODO DISPONIBILE AVAILABLE METHOD ДОСТУПНЫЙ МЕТОД	RESISTE RESISTANT СТОЙКАЯ
	RESISTENZA ALL'ATTACCO CHIMICO RESISTANCE TO CHEMICAL ATTACKS СТОЙКОСТЬ К ХИМИЧЕСКОМУ ВОЗДЕЙСТВИЮ	ISO 10545-13	min. UB	RESISTE RESISTANT СТОЙКАЯ
	RESISTENZA DEI COLORI ALLA LUCE COLOUR RESISTANCE TO LIGHT СВЕТООСТОЙКОСТЬ ЦВЕТОВ	DIN 51094	NON DEVONO PRESENTARE APPREZZABILI VARIAZIONI DI COLORE THE PRODUCT MUST NOT EVIDENCE CLEAR COLOUR VARIATIONS НЕ ДОЛЖНЫ ОБНАРУЖИВАТЬ ОЩУТИМЫХ ИЗМЕНЕНИЙ ЦВЕТА	RESISTE RESISTANT СТОЙКАЯ
	RESISTENZA ALLE MACCHIE STAIN RESISTANCE СТОЙКОСТЬ К ОБРАЗОВАНИЮ	ISO 10545-14	METODO DISPONIBILE AVAILABLE METHOD ДОСТУПНЫЙ МЕТОД	RESISTE RESISTANT СТОЙКАЯ
Material \approx 4,8 mm				
	COEFFICIENTE D'ATTRITO COEFFICIENT OF FRICTION КОЭФФИЦИЕНТ ТРЕНИЯ	DIN 51130	R10	
		DIN 51097	---	
		BCR	> 0,40	

Trattandosi di un prodotto tecnico a tutto impasto alcune impurità e puntinature visibili nei colori chiari sono da considerarsi una caratteristica tecnica del prodotto.
We produce technical unglazed porcelain stoneware slabs, and some light impurities and dots must be considered as a standard feature of the product.

Поскольку речь идет о технической продукции из однородной по всей толщине смеси, наличие некоторых примесей и точек на светлых цветах должно считаться характеристикой изделия.

I colori possono risultare falsati dai procedimenti litografici
The colours could be altered the lithographic printing process
Цвета могут казаться искаженными в результате литографических процессов

Per ulteriori informazioni visita il nostro sito: www.dsgceramiche.it
For further information visit: www.dsgceramiche.it
Для получения дополнительной информации посетите: www.dsgceramiche.it



DECORATORI BASSANESI SRL
VIA VALLINA ORTICELLA, 48 | 31030 BORSO DEL GRAPPA (TV)
+39 0 423 910076 | FAX +39 0 423 561188
dsgceramiche.it | info@dsgceramiche.it

