

**ARBI**  
BATHROOM

**RACCOLTA**  
LAVABI  
SPECCHIERE  
FARETTI  
VASCHE



reddot award 2017  
best of the best

WASHBASINS  
CONSOLE  
TOPS

VASQUES  
CONSOLE  
PLAN DE TOILETTE

LAVABI / BASINS / VASQUES

# LAVABI CONSOLLE PIANI TOP



## Sottopiano - ceramica/ceramic/c ramique

Lavabo ad incasso con esterno grezzo (con foro troppo pieno)  
Recessed undercounter washbasin with unfinished ext. (with overflow)  
Vasque encastr e avec externe non-fini (avec trop-plein)

Ceramica / ceramic / c ramique  
Vasca L 50,5 x P 35 x H 17 cm / interior W 50,5 x D 35 x H 17 cm  
Basi portal. min. L 70 cm / Washbasin units min. W 70 cm / Base lav. min. L 70 cm

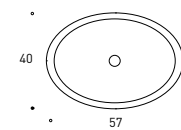

Art. **5540** - P. 257



## Quadro - ceramica/ceramic/c ramique

Lavabo ad incasso (con foro troppo pieno)  
Recessed undercounter washbasin (with overflow)  
Vasque encastr e (avec trop-plein)

Ceramica / ceramic / c ramique  
Vasca L 48 x P 29,5 x H 12,5 cm / interior W 48 x D 29,5 x H 12,5 cm  
Basi portal. min. L 70 cm / Washbasin units min. W 70 cm / Base lav. min. L 70 cm

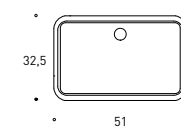

Art. **5542** - P. 257



## Nice 60 - 80 - ceramica/ceramic/c ramique

Lavabo sopra piano (senza foro troppo pieno)  
Overtop washbasin (without overflow)  
Vasque par dessus (sans trop-plein)

Ceramica / ceramic / c ramique  
Vasca L 58-78 x P 27,5 x H 8 cm / interior W 58-78 x D 27,5 x H 8 cm  
Basi portal. min. L 70 - 95 cm / washbasin units min. W 70 - 95 cm / base lav. min. L 70 - 95 cm

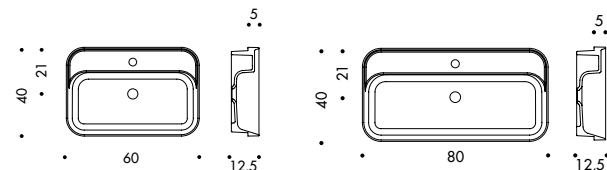

Art. **A026** - P. 257

Art. **A027** - P. 257



## Pretty 60 - 80 - ceramica/ceramic/c ramique

Lavabo semincasso (senza foro troppo pieno)  
Semi-recessed washbasin (without overflow)  
Vasque semi-encastr e (sans trop-plein)

Ceramica / ceramic / c ramique  
Vasca L 58-78 x P 27,5 x H 8 cm / interior W 58-78 x D 27,5 x H 8 cm  
Basi portal. min. L 70 - 85 cm / washbasin units min. W 70 - 85 cm / base lav. min. L 70 - 85 cm

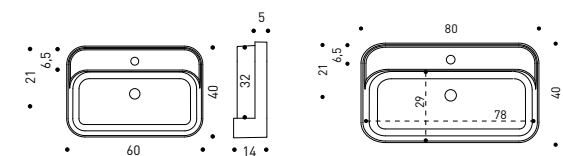

Art. **A041** - P. 257

Art. **A042** - P. 257



## Wonder 60 - ceramica/ceramic/c ramique

Lavabo TUTTO FUORI (con foro troppo pieno)  
TUTTO FUORI washbasin (with overflow)  
Vasque TUTTO FUORI (avec trop-plein)

Ceramica / ceramic / c ramique  
Vasca L 58,5 x P 35,5 x H 10 cm / interior W 58,5 x D 35,5 x H 10 cm  
Basi portal. min. L 70 cm / Washbasin units min. W 70 cm / Base lav. min. L 70 cm

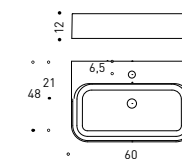

Art. **A342** - P. 258



## Wonder 80 - ceramica/ceramic/c ramique

Lavabo TUTTO FUORI (con foro troppo pieno)  
TUTTO FUORI washbasin (with overflow)  
Vasque TUTTO FUORI (avec trop-plein)

Ceramica / ceramic / c ramique  
Vasca L 78,5 x P 35,5 x H 10 cm / interior W 78,5 x D 35,5 x H 10 cm  
Basi portal. min. L 85 cm / Washbasin units min. W 85 cm / Base lav. min. L 85 cm

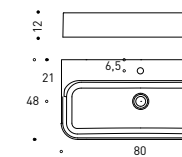

Art. **A343** - P. 258



## Beauty 40 - ceramica/ceramic/c ramique

Lavabo TUTTO FUORI (senza foro troppo pieno)  
TUTTO FUORI washbasin (without overflow)  
Vasque TUTTO FUORI (sans trop-plein)

Ceramica / ceramic / c ramique  
Vasca L 37 x P 35 x H 10 cm / interior W 37 x D 35 x H 10 cm  
Basi portal. min. L 50 cm / Washbasin units min. W 50 cm / Base lav. min. L 50 cm

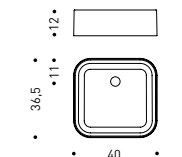

Art. **A023** - P. 258



## Beauty 60 - ceramica/ceramic/c ramique

Lavabo TUTTO FUORI (senza foro troppo pieno)  
TUTTO FUORI washbasin (without overflow)  
Vasque TUTTO FUORI (sans trop-plein)

Ceramica / ceramic / c ramique  
Vasca L 58 x P 36,5 x H 10 cm / interior W 58 x D 36,5 x H 10 cm  
Basi portal. min. L 70 cm / Washbasin units min. W 70 cm / Base lav. min. L 70 cm

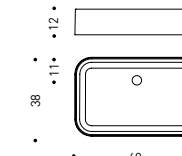

Art. **A024** - P. 258



## Beauty 80 - ceramica/ceramic/c ramique

Lavabo TUTTO FUORI (senza foro troppo pieno)  
TUTTO FUORI washbasin (without overflow)  
Vasque TUTTO FUORI (sans trop-plein)

**Ceramica / ceramic / c ramique**  
Vasca L 79 x P 36,5 x H 10 cm / interior W 79 x D 36,5 x H 10 cm / vasque int. L 79 x P 36,5 x H 10 cm  
Basi portal. min. L 85 cm / Washbasin units min. W 85 cm / Base lav. min. L 85 cm

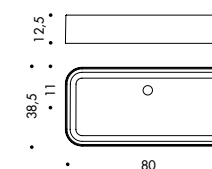

Art. **A025** - P. 258



## Ciotolina - ceramica/ceramic/c ramique

Lavabo TUTTO FUORI (senza foro troppo pieno)  
TUTTO FUORI washbasin (without overflow)  
Vasque TUTTO FUORI (sans trop-plein)

**Ceramica / ceramic / c ramique**  
Vasca L 39 x P 39 x H 10 cm / interior W 39 x D 39 x H 10 cm / vasque int. L 39 x P 39 x H 10 cm  
Basi portal. min. L 50 cm / Washbasin units min. W 50 cm / Base lav. min. L 50 cm

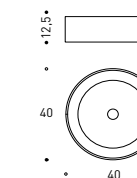

Art. **A344** - P. 259



## Azuley - ceramica/ceramic/c ramique

Lavabo TUTTO FUORI (con foro troppo pieno)  
TUTTO FUORI washbasin (with overflow)  
Vasque TUTTO FUORI (avec trop-plein)

**Ceramica / ceramic / c ramique**  
Vasca L 36 x P 36 x H 14,5 cm / interior W 36 x D 436 x H 14,5 cm / vasque int. L 36 x P 36 x H 14,5 cm  
Basi portal. min. L 60 cm / Washbasin units min. W 60 cm / Base lav. min. L 60 cm

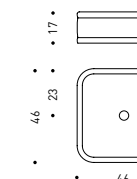

Art. **A032** - P. 258



## Golfo - ceramica/ceramic/c ramique

Lavabo TUTTO FUORI (con foro troppo pieno)  
TUTTO FUORI washbasin (with overflow)  
Vasque TUTTO FUORI (avec trop-plein)

**Ceramica / ceramic / c ramique**  
Vasca L 60 x P 35 x H 14 cm / interior W 60 x D 35 x H 14 cm / vasque int. L 60 x P 35 x H 14 cm  
Basi portal. min. L 50 cm / Washbasin units min. W 50 cm / Base lav. min. L 50 cm

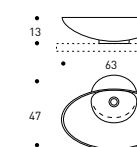

Art. **5618** - P. 258



## Cow - ceramica/ceramic/c ramique

Lavabo TUTTO FUORI (con foro troppo pieno)  
TUTTO FUORI washbasin (with overflow)  
Vasque TUTTO FUORI (avec trop-plein)

Ceramica / ceramic / c ramique

Vasca L 53 x P 30 x H 14 cm / interior W 53 x D 30 x H 14 cm / vasque int. L 53 x P 30 x H 14 cm  
Basi portal. min. L 70 cm / Washbasin units min. W 70 cm / Base lav. min. L 70 cm

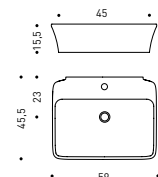

Art. **A035** - P. 258



## Soffice Out - ceramica/ceramic/c ramique

Lavabo TUTTO FUORI (senza foro troppo pieno)  
TUTTO FUORI washbasin (without overflow)  
Vasque TUTTO FUORI (sans trop-plein)

Ceramica / ceramic / c ramique

Vasca L 57 x P 39,5 x H 14,5 cm / interior W 57 x D 39,5 x H 14,5 cm / vasque int. L 57 x P 39,5 x H 14,5 cm  
Basi portal. min. L 50 cm / Washbasin units min. W 50 cm / Base lav. min. L 50 cm

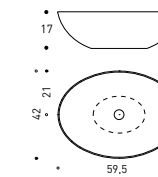

Art. **A451** - P. 259



## Star 43 - ceramica/ceramic/c ramique

Lavabo TUTTO FUORI (senza foro troppo pieno)  
TUTTO FUORI washbasin (without overflow)  
Vasque TUTTO FUORI (sans trop-plein)

Ceramica / ceramic / c ramique

Vasca L 36,5 x P 36,5 x H 11,5 cm / interior W 36,5 x D 36,5 x H 11,5 cm / vasque int. L 36,5 x P 36,5 x H 11,5 cm  
Basi portal. min. L 50 cm / Washbasin units min. W 50 cm / Base lav. min. L 50 cm

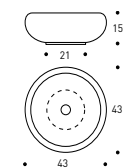

Art. **5494** - P. 259



## Soffice In - ceramica/ceramic/c ramique

Lavabo TUTTO FUORI (senza foro troppo pieno)  
TUTTO FUORI washbasin (without overflow)  
Vasque TUTTO FUORI (sans trop-plein)

Ceramica / ceramic / c ramique

Vasca L 57 x P 32 x H 14,5 cm / interior W 57 x D 32 x H 14,5 cm / vasque int. L 57 x P 32 x H 14,5 cm  
Basi portal. min. L 50 cm / Washbasin units min. W 50 cm / Base lav. min. L 50 cm

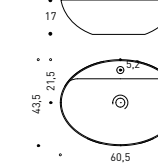

Art. **A452** - P. 259



## Star 60 - ceramica/ceramic/c ramique

Lavabo TUTTO FUORI (senza foro troppo pieno)  
TUTTO FUORI washbasin (without overflow)  
Vasque TUTTO FUORI (sans trop-plein)

Ceramica / ceramic / c ramique

Vasca L 55 x P 36 x H 11 cm / interior W 55 x D 36 x H 11 cm / vasque int. L 55 x P 36 x H 11 cm  
Basi portal. min. L 50 cm / Washbasin units min. W 50 cm / Base lav. min. L 50 cm

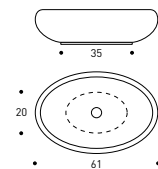

Art. **5495** - P. 259



## Trace - ceramica/ceramic/c ramique

Lavabo TUTTO FUORI (senza foro troppo pieno) - comprensivo di piletta Stop & Go in ceramica  
TUTTO FUORI washbasin (without overflow) - pop-up ceramic plug included  
Vasque TUTTO FUORI (sans trop-plein) - bonde Stop & Go en c ramique inclus

Ceramica / ceramic / c ramique

Vasca L 35 x P 35 x H 12 cm / interior W 35 x D 35 x H 12 cm / vasque int. L 35 x P 35 x H 12 cm  
Basi portal. min. L 50 cm / Washbasin units min. W 50 cm / Base lav. min. L 50 cm

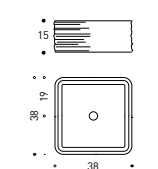

Art. **A351** - P. 260



## Midas - ceramica/ceramic/c ramique

Lavabo TUTTO FUORI (senza foro troppo pieno)  
TUTTO FUORI washbasin (without overflow)  
Vasque TUTTO FUORI (sans trop-plein)

Ceramica / ceramic / c ramique

Vasca L 64,5 x P 32 x H 12 cm / interior W 64,5 x D 32 x H 12 cm / vasque int. L 64,5 x P 32 x H 12 cm  
Basi portal. min. L 70 cm / Washbasin units min. W 70 cm / Base lav. min. L 70 cm

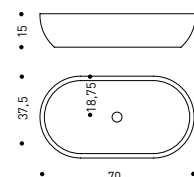

Art. **A031** - P. 259



## Trace Azzurro - ceramica/ceramic/c ramique

Lavabo TUTTO FUORI (senza foro troppo pieno) - comprensivo di piletta Stop & Go in ceramica  
TUTTO FUORI washbasin (without overflow) - pop-up ceramic plug included  
Vasque TUTTO FUORI (sans trop-plein) - bonde Stop & Go en c ramique inclus

Ceramica azzurra opaca / matt pale blu ceramic / c ramique azzurra mat

Vasca L 35 x P 35 x H 12 cm / interior W 35 x D 35 x H 12 cm / vasque int. L 35 x P 35 x H 12 cm  
Basi portal. min. L 50 cm / Washbasin units min. W 50 cm / Base lav. min. L 50 cm

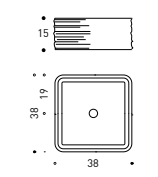

Art. **A352** - P. 260



## Seed Basso - ceramica/ceramic/c eramique

Lavabo TUTTO FUORI (senza foro troppo pieno) - comprensivo di piletta Stop & Go in ceramica  
TUTTO FUORI washbasin (without overflow) - pop-up ceramic plug included  
Vasque TUTTO FUORI (sans trop-plein) - bonde Stop & Go en c eramique inclus

Ceramica / ceramic / c eramique  
Vasca L 43 x P 43 x H 10 cm / interior W 43 x D 43 x H 10 cm / vasque int. L 43 x P 43 x H 10 cm  
Basi portal. min. L 50 cm / Washbasin units min. W 50 cm / Base lav. min. L 50 cm

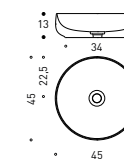

Art. **A348** - P. 260



## Seed Alto - ceramica/ceramic/c eramique

Lavabo TUTTO FUORI (senza foro troppo pieno) - comprensivo di piletta Stop & Go in ceramica  
TUTTO FUORI washbasin (without overflow) - pop-up ceramic plug included  
Vasque TUTTO FUORI (sans trop-plein) - bonde Stop & Go en c eramique inclus

Ceramica / ceramic / c eramique  
Vasca L 38 x P 38 x H 15 cm / interior W 38 x D 38 x H 15 cm / vasque int. L 38 x P 38 x H 15 cm  
Basi portal. min. L 50 cm / Washbasin units min. W 50 cm / Base lav. min. L 50 cm

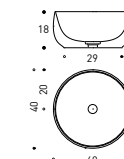

Art. **A347** - P. 260



## Seed 45 - ceramica/ceramic/c eramique

Lavabo TUTTO FUORI (senza foro troppo pieno) - comprensivo di piletta Stop & Go in ceramica  
TUTTO FUORI washbasin (without overflow) - pop-up ceramic plug included  
Vasque TUTTO FUORI (sans trop-plein) - bonde Stop & Go en c eramique inclus

Ceramica / ceramic / c eramique  
Vasca L 43 x P 38 x H 12 cm / interior W 43 x D 38 x H 12 cm / vasque int. L 43 x P 38 x H 12 cm  
Basi portal. min. L 50 cm / Washbasin units min. W 50 cm / Base lav. min. L 50 cm

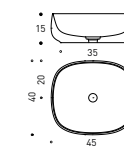

Art. **A349** - P. 260



## Seed 55 - ceramica/ceramic/c eramique

Lavabo TUTTO FUORI (senza foro troppo pieno) - comprensivo di piletta Stop & Go in ceramica  
TUTTO FUORI washbasin (without overflow) - pop-up ceramic plug included  
Vasque TUTTO FUORI (sans trop-plein) - bonde Stop & Go en c eramique inclus

Ceramica / ceramic / c eramique  
Vasca L 53 x P 40 x H 12 cm / interior W 53 x D 40 x H 12 cm / vasque int. L 53 x P 40 x H 12 cm  
Basi portal. min. L 60 cm / Washbasin units min. W 60 cm / Base lav. min. L 60 cm

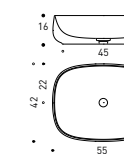

Art. **A350** - P. 260



## Omega 60 - ceramica/ceramic/c eramique

Lavabo TUTTO FUORI (senza foro troppo pieno)  
TUTTO FUORI washbasin (without overflow)  
Vasque TUTTO FUORI (sans trop-plein)

Ceramica / ceramic / c eramique

Vasca L 59 x P 37 x H 10 cm / interior W 59 x D 37 x H 10 cm / vasque int. L 59 x P 37 x H 10 cm  
Basi portal. min. L 60 cm / Washbasin units min. W 60 cm / Base lav. min. L 60 cm

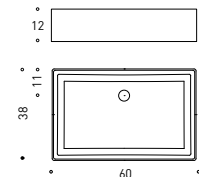

Art. **A345** - P. 259



## Omega 80 - ceramica/ceramic/c eramique

Lavabo TUTTO FUORI (senza foro troppo pieno)  
TUTTO FUORI washbasin (without overflow)  
Vasque TUTTO FUORI (sans trop-plein)

Ceramica / ceramic / c eramique

Vasca L 79 x P 37 x H 10 cm / interior W 79 x D 37 x H 10 cm / vasque int. L 79 x P 37 x H 10 cm  
Basi portal. min. L 85 cm / Washbasin units min. W 85 cm / Base lav. min. L 85 cm

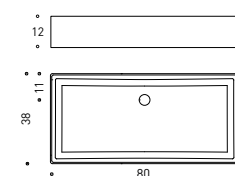

Art. **A346** - P. 259



## Delta 60 - ceramica/ceramic/c eramique

Lavabo TUTTO FUORI (con foro troppo pieno)  
TUTTO FUORI washbasin (with overflow)  
Vasque TUTTO FUORI (avec trop-plein)

Ceramica / ceramic / c eramique

Vasca L 58,5 x P 33 x H 10 cm / interior W 58,5 x D 33 x H 10 cm / vasque int. L 58,5 x P 33 x H 10 cm  
Basi portal. min. L 70 cm / Washbasin units min. W 70 cm / Base lav. min. L 70 cm

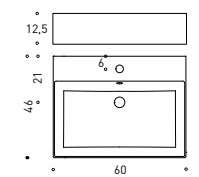

Art. **A353** - P. 260



## Delta 80 - ceramica/ceramic/c eramique

Lavabo TUTTO FUORI (con foro troppo pieno)  
TUTTO FUORI washbasin (with overflow)  
Vasque TUTTO FUORI (avec trop-plein)

Ceramica / ceramic / c eramique

Vasca L 78,5 x P 33 x H 10 cm / interior W 78,5 x D 33 x H 10 cm / vasque int. L 78,5 x P 33 x H 10 cm  
Basi portal. min. L 85 cm / Washbasin units min. W 85 cm / Base lav. min. L 85 cm

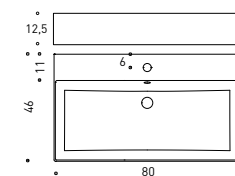

Art. **A354** - P. 260



## Clean - tekno

Lavabo TUTTO FUORI (senza foro troppo pieno)  
TUTTO FUORI washbasin (without overflow)  
Vasque TUTTO FUORI (sans trop-plein)

Tekno / tekno / tekno

Vasca L 58 x P 33 x H 10,5 cm / interior W 58 x D 33 x H 10,5 cm / vasque int. L 58 x P 33 x H 10,5 cm  
Basi portal. min. L 50 cm / Washbasin units min. W 50 cm / Base lav. min. L 50 cm

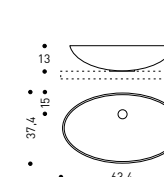

Art. **5613** - P. 261



## Vela - tekno

Lavabo TUTTO FUORI (senza foro troppo pieno)  
TUTTO FUORI washbasin (without overflow)  
Vasque TUTTO FUORI (sans trop-plein)

Tekno / tekno / tekno

Vasca L 62 x P 30 x H 12 cm / interior W 62 x D 30 x H 12 cm / vasque int. L 62 x P 30 x H 12 cm  
Basi portal. min. L 50 cm / Washbasin units min. W 50 cm / Base lav. min. L 50 cm

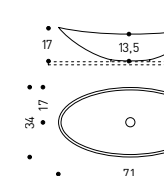

Art. **A600** - P. 261



## Lady 55 - tekno

Lavabo TUTTO FUORI (senza foro troppo pieno)  
TUTTO FUORI washbasin (without overflow)  
Vasque TUTTO FUORI (sans trop-plein)

Tekno / tekno / tekno

Vasca L 53 x P 35 x H 9 cm / interior W 53 x D 35 x H 9 cm / vasque int. L 53 x P 35 x H 9 cm  
Basi portal. min. L 60 cm / Washbasin units min. W 50 cm / Base lav. min. L 50 cm

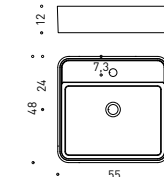

Art. **A355** - P. 261



## Lady 70 - tekno

Lavabo TUTTO FUORI (senza foro troppo pieno)  
TUTTO FUORI washbasin (without overflow)  
Vasque TUTTO FUORI (sans trop-plein)

Tekno / tekno / tekno

Vasca L 68 x P 35 x H 9 cm / interior W 68 x D 35 x H 9 cm / vasque int. L 68 x P 35 x H 9 cm  
Basi portal. min. L 85 cm / Washbasin units min. W 85 cm / Base lav. min. L 85 cm

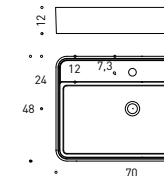

Art. **A356** - P. 261



## Miss 60 - tekno

Lavabo TUTTO FUORI (senza foro troppo pieno) comprensivo di tappo copripiletta /  
TUTTO FUORI washbasin (without overflow) including cover in tekno /  
Vasque TUTTO FUORI (sans trop-plein) avec bouchon en tekno.

Tekno / tekno / tekno

Vasca L 59 x P 34 x H 10 cm / interior W 59 x D 34 x H 10 cm / vasque int. L 59 x P 34 x H 10 cm  
Basi portal. min. L 70 cm / Washbasin units min. W 70 cm / Base lav. min. L 70 cm

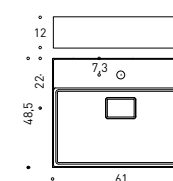

Art. **A357** - P. 261



## Miss 80 - tekno

Lavabo TUTTO FUORI (senza foro troppo pieno) comprensivo di tappo copripiletta /  
TUTTO FUORI washbasin (without overflow) including cover in tekno /  
Vasque TUTTO FUORI (sans trop-plein) avec bouchon en tekno.

Tekno / tekno / tekno

Vasca L 79 x P 34 x H 10 cm / interior W 79 x D 34 x H 10 cm / vasque int. L 79 x P 34 x H 10 cm  
Basi portal. min. L 85 cm / Washbasin units min. W 85 cm / Base lav. min. L 85 cm

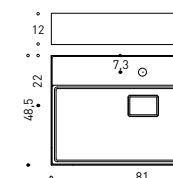

Art. **A358** - P. 261



## Miss 100 - tekno

Lavabo TUTTO FUORI (senza foro troppo pieno) comprensivo di tappo copripiletta /  
TUTTO FUORI washbasin (without overflow) including cover in tekno /  
Vasque TUTTO FUORI (sans trop-plein) avec bouchon en tekno.

Tekno / tekno / tekno

Vasca L 99 x P 34 x H 10 cm / interior W 99 x D 34 x H 10 cm / vasque int. L 99 x P 34 x H 10 cm  
Basi portal. min. L 105 cm / Washbasin units min. W 105 cm / Base lav. min. L 105 cm

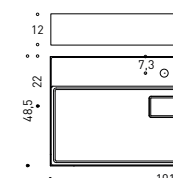

Art. **A359** - P. 261



## Sandia tekno - tekno

Lavabo TUTTO FUORI (senza foro troppo pieno) comprensivo di piletta /  
TUTTO FUORI washbasin (without overflow) including plug /  
Vasque TUTTO FUORI (sans trop-plein) avec bonde.

Tekno / tekno / tekno

Vasca L 52,5 x P 35 x H 26,5 cm / interior W 52,5 x D 35 x H 26,5 cm / vasque int. L 52,5 x P 35 x H 26,5 cm  
Basi portal. min. L 60 cm / Washbasin units min. W 60 cm / Base lav. min. L 60 cm

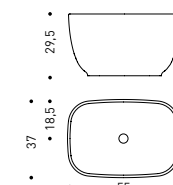

Art. **A005** - P. 262







## King - tekno

Lavabo TUTTO FUORI (senza foro troppo pieno)  
TUTTO FUORI washbasin (without overflow)  
Vasque TUTTO FUORI (sans trop-plein)

Tekno / tekno / tekno

Vasca L 58 x P 38 x H 17 cm / interior W 58 x D 38 x H 17 cm / vasque int. L 58 x P 38 x H 17 cm  
Basi portal. min. L 50 cm / Washbasin units min. W 50 cm / Base lav. min. L 50 cm

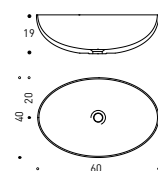

Art. **A361** - P. 262



## Semisfera - tekno

Lavabo TUTTO FUORI (senza foro troppo pieno)  
TUTTO FUORI washbasin (without overflow)  
Vasque TUTTO FUORI (sans trop-plein)

Tekno / tekno / tekno

Vasca L 40 x P 40 x H 17 cm / interior W 40 x D 40 x H 17 cm / vasque int. L 40 x P 40 x H 17 cm  
Basi portal. min. L 50 cm / Washbasin units min. W 50 cm / Base lav. min. L 50 cm

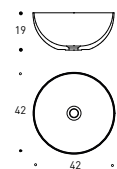

Art. **A360** - P. 262



## Sandia mineralguss - mineralguss

Lavabo TUTTO FUORI (senza foro troppo pieno) comprensivo di piletta /  
TUTTO FUORI washbasin (without overflow) including plug /  
Vasque TUTTO FUORI (sans trop-plein) avec bonde.

Mineralguss / mineralguss / mineralguss

Vasca L 52,5 x P 35,5 x H 26 cm / interior W 52,5 x D 35,5 x H 26 cm / vasque int. L 52,5 x P 35,5 x H 26 cm  
Basi portal. min. L 60 cm / Washbasin units min. W 60 cm / Base lav. min. L 60 cm

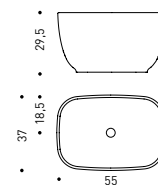

Art. **A705** - P. 262



## Geo - mineralguss

Lavabo TUTTO FUORI (senza foro troppo pieno)  
TUTTO FUORI washbasin (without overflow)  
Vasque TUTTO FUORI (sans trop-plein)

Mineralguss / mineralguss / mineralguss

Vasca L 56 x P 34 x H 11 cm / interior W 56 x D 34 x H 11 cm / vasque int. L 56 x P 34 x H 11 cm  
Basi portal. min. L 60 cm / Washbasin units min. W 60 cm / Base lav. min. L 60 cm

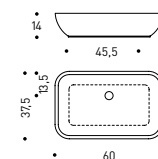

Art. **A534** - P. 262



## Gold - vetro / glass / verre

Lavabo TUTTO FUORI (senza foro troppo pieno)  
TUTTO FUORI washbasin (without overflow)  
Vasque TUTTO FUORI (sans trop-plein)

Vetro / glass / verre

Vasca L 37 x P 37 x H 13 cm / interior W 37 x D 37 x H 13 cm / vasque int. L 37 x P 37 x H 13 cm  
Basi portal. min. L 50 cm / Washbasin units min. W 50 cm / Base lav. min. L 50 cm

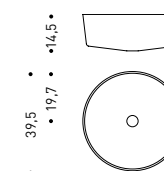

Art. **A033** - P. 262

# Bart

ceramica/ceramic/c ramique



## Bart 72

Consolle H 7 cm (con foro troppo pieno)  
H 7 cm console (with overflow)  
Consolle H 7 cm (avec trop-plein)

Ceramica / ceramic / c ramique  
Vasca L 51 x P 29,5 x H 15 cm / interior W 51 x D 29,5 x H 15 cm / vasque int. L 51 x P 29,5 x H 15 cm  
Per basi portlavabo L 70 x P 37 cm / for washbasin units W 70 x D 37 cm / base lavabo L 70 x P 37 cm

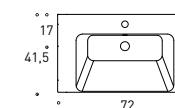

Art. **A442** - P. 269



## Bart 87

Consolle H 7 cm (con foro troppo pieno)  
H 7 cm console (with overflow)  
Consolle H 7 cm (avec trop-plein)

Ceramica / ceramic / c ramique  
Vasca L 51 x P 29 x H 15 cm / interior W 51 x D 29 x H 15 cm / vasque int. L 51 x P 29 x H 15 cm  
Per basi portlavabo L 85 x P 37 cm / for washbasin units W 85 x D 37 cm / base lavabo L 85 x P 37 cm

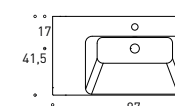

Art. **A443** - P. 269



## Bart 97

Consolle H 7 cm (con foro troppo pieno)  
H 7 cm console (with overflow)  
Consolle H 7 cm (avec trop-plein)

Ceramica / ceramic / c ramique  
Vasca L 56 x P 29 x H 15 cm / interior W 56 x D 29 x H 15 cm / vasque int. L 56 x P 29 x H 15 cm  
Per basi portlavabo L 95 x P 37 cm / for washbasin units W 95 x D 37 cm / base lavabo L 95 x P 37 cm

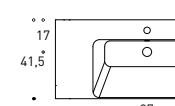

Art. **A444** - P. 269



## Bart 107

Consolle H 7 cm (con foro troppo pieno)  
H 7 cm console (with overflow)  
Consolle H 7 cm (avec trop-plein)

Ceramica / ceramic / c ramique  
Vasca L 56 x P 29 x H 15 cm / interior W 56 x D 29 x H 15 cm / vasque int. L 56 x P 29 x H 15 cm  
Per basi portlavabo L 107 x P 37 cm / for washbasin units W 107 x D 37 cm / base lavabo L 107 x P 37 cm

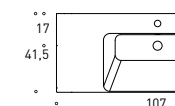

Art. **A445** - P. 269



## Bart 62

Consolle H 7 cm (con foro troppo pieno)  
H 7 cm console (with overflow)  
Consolle H 7 cm (avec trop-plein)

Ceramica / ceramic / c ramique  
Vasca L 51 x P 29,5 x H 15 cm / interior W 51 x D 29,5 x H 15 cm / vasque int. L 51 x P 29,5 x H 15 cm  
Per basi portlavabo L 60 x P 37 cm / for washbasin units W 60 x D 37 cm / base lavabo L 60 x P 37 cm

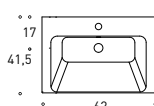

Art. **A441** - P. 269



## Bart 107 dx-sx / rh-lh / dr-ga

Consolle H 7 cm (con foro troppo pieno)  
H 7 cm console (with overflow)  
Consolle H 7 cm (avec trop-plein)

Ceramica / ceramic / céramique  
Vasca L 56 x P 29 x H 15 cm / interior W 56 x D 29 x H 15 cm / vasque int. L 56 x P 29 x H 15 cm  
Per basi portlavabo L 105 x P 37 cm / for washbasin units W 105 x D 37 cm / base lavabo L 105 x P 37 cm

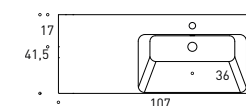

Art. **A447** (vasca DX) - Art. **A446** (vasca SX) P. 269



## Bart 122

Consolle H 7 cm (con foro troppo pieno)  
H 7 cm console (with overflow)  
Consolle H 7 cm (avec trop-plein)

Ceramica / ceramic / céramique  
Vasca L 56 x P 29 x H 15 cm / interior W 56 x D 29 x H 15 cm / vasque int. L 56 x P 29 x H 15 cm  
Per basi portlavabo L 120 x P 37 cm / for washbasin units W 120 x D 37 cm / base lavabo L 120 x P 37 cm

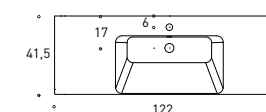

Art. **A448** - P. 269



## Bart 122 dx-sx / rh-lh / dr-ga

Consolle H 7 cm (con foro troppo pieno)  
H 7 cm console (with overflow)  
Consolle H 7 cm (avec trop-plein)

Ceramica / ceramic / céramique  
Vasca L 56 x P 29 x H 15 cm / interior W 56 x D 29 x H 15 cm / vasque int. L 56 x P 29 x H 15 cm  
Per basi portlavabo L 120 x P 37 cm / for washbasin units W 120 x D 37 cm / base lavabo L 120 x P 37 cm

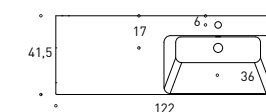

Art. **A449** (vasca DX) - Art. **A456** (vasca SX) P. 269

# Grace

ceramica/ceramic/c ramique



## Grace 70

Consolle H 3,5 cm (con foro troppo pieno, compreso di piletta Stop & Go in ceramica)  
H 3,5 cm console (with overflow, including Stop &Go ceramic plug)  
Consolle H 3,5 cm (avec trop-plein, avec bonde Stop & Go en c ramique)

Ceramica / ceramic / c ramique  
Vasca L 56 x P 27 x H 12,5 cm / interior W 56 x D 27 x H 12,5 cm / vasque int. L 56 x P 27 x H 12,5 cm  
Per basi port lavabo L 70 x P 37 cm / for washbasin units W 70 x D 37 cm / base lavabo L 70 x P 37 cm

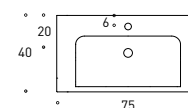

Art. **A362** - P. 270



## Grace 85

Consolle H 3,5 cm (con foro troppo pieno, compreso di piletta Stop & Go in ceramica)  
H 3,5 cm console (with overflow, including Stop &Go ceramic plug)  
Consolle H 3,5 cm (avec trop-plein, avec bonde Stop & Go en c ramique)

Ceramica / ceramic / c ramique  
Vasca L 66 x P 27 x H 12,5 cm / interior W 66 x D 27 x H 12,5 cm / vasque int. L 66 x P 27 x H 12,5 cm  
Per basi port lavabo L 85 x P 37 cm / for washbasin units W 85 x D 37 cm / base lavabo L 85 x P 37 cm

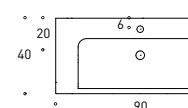

Art. **A363** - P. 270



## Grace 95

Consolle H 3,5 cm (con foro troppo pieno, compreso di piletta Stop & Go in ceramica)  
H 3,5 cm console (with overflow, including Stop &Go ceramic plug)  
Consolle H 3,5 cm (avec trop-plein, avec bonde Stop & Go en c ramique)

Ceramica / ceramic / c ramique  
Vasca L 66 x P 27 x H 12,5 cm / interior W 66 x D 27 x H 12,5 cm / vasque int. L 66 x P 27 x H 12,5 cm  
Per basi port lavabo L 95 x P 37 cm / for washbasin units W 95 x D 37 cm / base lavabo L 95 x P 37 cm

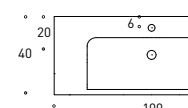

Art. **A364** - P. 270



## Grace 105

Consolle H 3,5 cm (con foro troppo pieno, compreso di piletta Stop & Go in ceramica)  
H 3,5 cm console (with overflow, including Stop &Go ceramic plug)  
Consolle H 3,5 cm (avec trop-plein, avec bonde Stop & Go en c ramique)

Ceramica / ceramic / c ramique  
Vasca L 66 x P 27 x H 12,5 cm / interior W 66 x D 27 x H 12,5 cm / vasque int. L 66 x P 27 x H 12,5 cm  
Per basi port lavabo L 105 x P 37 cm / for washbasin units W 105 x D 37 cm / base lavabo L 105 x P 37 cm

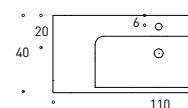

Art. **A365** - P. 270



## Splash 73

Consolle H 9,5 cm (con foro troppo pieno)  
H 9,5 cm console (with overflow)  
Consolle H 9,5 cm (avec trop-plein)

Ceramica / ceramic / céramique  
Vasca L 53 x P 32 x H 14 cm / interior W 53 x D 32 x H 14 cm / vasque int. L 53 x P 32 x H 14 cm  
Per basi portalavabo L 70 x P 37 cm / for washbasin units W 70 x D 37 cm / base lavabo L 70 x P 37 cm

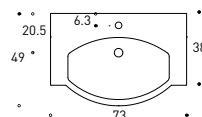

Art. **A567** - P. 270



## Splash 88

Consolle H 9,5 cm (con foro troppo pieno)  
H 9,5 cm console (with overflow)  
Consolle H 9,5 cm (avec trop-plein)

Ceramica / ceramic / céramique  
Vasca L 65 x P 32 x H 14 cm / interior W 65 x D 32 x H 14 cm / vasque int. L 65 x P 32 x H 14 cm  
Per basi portalavabo L 85 x P 37 cm / for washbasin units W 85 x D 37 cm / base lavabo L 85 x P 37 cm

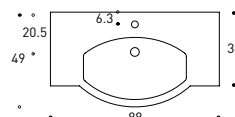

Art. **A568** - P. 270



## Splash 98

Consolle H 9,5 cm (con foro troppo pieno)  
H 9,5 cm console (with overflow)  
Consolle H 9,5 cm (avec trop-plein)

Ceramica / ceramic / céramique  
Vasca L 65 x P 32 x H 14 cm / interior W 65 x D 32 x H 14 cm / vasque int. L 65 x P 32 x H 14 cm  
Per basi portalavabo L 95 x P 37 cm / for washbasin units W 95 x D 37 cm / base lavabo L 95 x P 37 cm

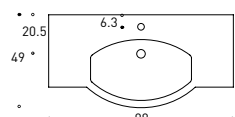

Art. **A569** - P. 270



## Splash 108

Consolle H 9,5 cm (con foro troppo pieno)  
H 9,5 cm console (with overflow)  
Consolle H 9,5 cm (avec trop-plein)

Ceramica / ceramic / céramique  
Vasca L 65 x P 32 x H 14 cm / interior W 65 x D 32 x H 14 cm / vasque int. L 65 x P 32 x H 14 cm  
Per basi portalavabo L 105 x P 37 cm / for washbasin units W 105 x D 37 cm / base lavabo L 105 x P 37 cm

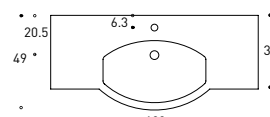

Art. **A570** - P. 270



Splash  
ceramica/ceramic/céramique

# Today

mineralguss/mineralguss/mineralguss



reddot design award  
best of the best 2017

**MENEGHELLO PAOLELLI**  
ASSOCIATI

## Today 61

Consolle H 8 cm (senza foro troppo pieno)  
H 8 cm console (without overflow)  
Consolle H 8 cm (sans trop-plein)

Mineralguss / mineralguss / mineralguss  
Vasca L 60 x P 30 x H 13 cm / interior W 60 x D 30 x H 13 cm / vasque int. L 60 x P 30 x H 13 cm  
Per basi portalavabo L 60 x P 37 cm / for washbasin units W 60 x D 37 cm / base lavabo L 60 x P 37 cm

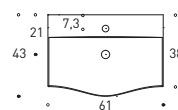

Art. **A366** - P. 271



## Today 71

Consolle H 8 cm (senza foro troppo pieno)  
H 8 cm console (without overflow)  
Consolle H 8 cm (sans trop-plein)

Mineralguss / mineralguss / mineralguss  
Vasca L 70 x P 30 x H 13 cm / interior W 70 x D 30 x H 13 cm / vasque int. L 70 x P 30 x H 13 cm  
Per basi portalavabo L 70 x P 37 cm / for washbasin units W 70 x D 37 cm / base lavabo L 70 x P 37 cm

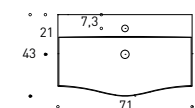

Art. **A367** - P. 271



## Today 86

Consolle H 8 cm (senza foro troppo pieno)  
H 8 cm console (without overflow)  
Consolle H 8 cm (sans trop-plein)

Mineralguss / mineralguss / mineralguss  
Vasca L 85 x P 30 x H 13 cm / interior W 85 x D 30 x H 13 cm / vasque int. L 85 x P 30 x H 13 cm  
Per basi portalavabo L 85 x P 37 cm / for washbasin units W 85 x D 37 cm / base lavabo L 85 x P 37 cm

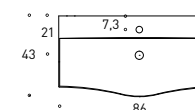

Art. **A368** - P. 271



## Today 96

Consolle H 8 cm (senza foro troppo pieno)  
H 8 cm console (without overflow)  
Consolle H 8 cm (sans trop-plein)

Mineralguss / mineralguss / mineralguss  
Vasca L 95 x P 30 x H 13 cm / interior W 95 x D 30 x H 13 cm / vasque int. L 95 x P 30 x H 13 cm  
Per basi portalavabo L 95 x P 37 cm / for washbasin units W 95 x D 37 cm / base lavabo L 95 x P 37 cm

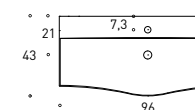

Art. **A369** - P. 271



## Today 106

Consolle H 8 cm (senza foro troppo pieno)  
H 8 cm console (without overflow)  
Consolle H 8 cm (sans trop-plein)

Mineralguss / mineralguss / mineralguss  
Vasca L 105 x P 30 x H 13 cm / interior W 105 x D 30 x H 13 cm / vasque int. L 105 x P 30 x H 13 cm  
Per basi portalavabo L 105 x P 37 cm / for washbasin units W 105 x D 37 cm / base lavabo L 105 x P 37 cm

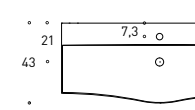

Art. **A370** - P. 271

# Qubo

ceramica/ceramic/c ramique



## Qubo 86

Consolle H 1,5 cm (con foro troppo pieno)  
H 1,5 cm console (with overflow)  
Consolle H 1,5 cm (avec trop-plein)

Ceramica / ceramic / c ramique  
Vasca L 57 x P 33 x H 12,5 cm / interior W 57 x D 33 x H 12,5 cm / vasque int. L 57 x P 33 x H 12,5 cm  
Per basi port lavabo L 85 x P 50 cm / for washbasin units W 85 x D 50 cm / base lavabo L 85 x P 50 cm

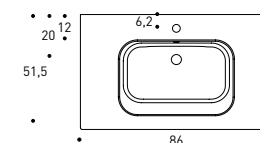

Art. **A737** - P. 272



## Qubo 96

Consolle H 1,5 cm (con foro troppo pieno)  
H 1,5 cm console (with overflow)  
Consolle H 1,5 cm (avec trop-plein)

Ceramica / ceramic / c ramique  
Vasca L 57 x P 33 x H 12,5 cm / interior W 57 x D 33 x H 12,5 cm / vasque int. L 57 x P 33 x H 12,5 cm  
Per basi port lavabo L 95 x P 50 cm / for washbasin units W 95 x D 50 cm / base lavabo L 95 x P 50 cm

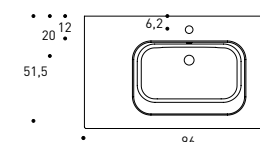

Art. **A738** - P. 272



## Qubo 106

Consolle H 1,5 cm (con foro troppo pieno)  
H 1,5 cm console (with overflow)  
Consolle H 1,5 cm (avec trop-plein)

Ceramica / ceramic / c ramique  
Vasca L 57 x P 33 x H 12,5 cm / interior W 57 x D 33 x H 12,5 cm / vasque int. L 57 x P 33 x H 12,5 cm  
Per basi port lavabo L 105 x P 50 cm / for washbasin units W 105 x D 50 cm / base lavabo L 105 x P 50 cm

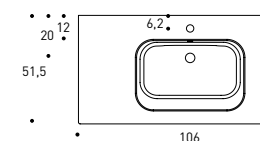

Art. **A739** - P. 272



## Qubo 106 dx-sx / rh-lh / dr-ga

Consolle H 1,5 cm (con foro troppo pieno)  
H 1,5 cm console (with overflow)  
Consolle H 1,5 cm (avec trop-plein)

Ceramica / ceramic / c ramique  
Vasca L 57 x P 33 x H 12,5 cm / interior W 57 x D 33 x H 12,5 cm / vasque int. L 57 x P 33 x H 12,5 cm  
Per basi port lavabo L 105 x P 50 cm / for washbasin units W 105 x D 50 cm / base lavabo L 105 x P 50 cm

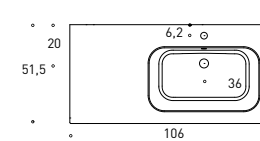

Art. **A371** (vasca DX) - Art. **A372** (vasca SX) P. 272



## Qubo 71

Consolle H 1,5 cm (con foro troppo pieno)  
H 1,5 cm console (with overflow)  
Consolle H 1,5 cm (avec trop-plein)

Ceramica / ceramic / c ramique  
Vasca L 57 x P 33 x H 12,5 cm / interior W 57 x D 33 x H 12,5 cm / vasque int. L 57 x P 33 x H 12,5 cm  
Per basi port lavabo L 70 x P 50 cm / for washbasin units W 70 x D 50 cm / base lavabo L 70 x P 50 cm

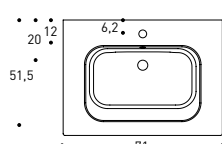

Art. **A736** - P. 272



## Qubo 121

Consolle H 1,5 cm (con foro troppo pieno)  
H 1,5 cm console (with overflow)  
Consolle H 1,5 cm (avec trop-plein)

**Ceramica / ceramic / céramique**

Vasca L 57 x P 33 x H 12,5 cm / interior W 57 x D 33 x H 12,5 cm / vasque int. L 57 x P 33 x H 12,5 cm  
Per basi portlavabo L 120 x P 50 cm / for washbasin units W 120 x D 50 cm / base lavabo L 120 x P 50 cm

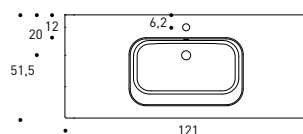

Art. **A036** - P. 272



## Qubo 121 dx-sx / rh-lh / dr-ga

Consolle H 1,5 cm (con foro troppo pieno)  
H 1,5 cm console (with overflow)  
Consolle H 1,5 cm (avec trop-plein)

**Ceramica / ceramic / céramique**

Vasca L 57 x P 33 x H 12,5 cm / interior W 57 x D 33 x H 12,5 cm / vasque int. L 57 x P 33 x H 12,5 cm  
Per basi portlavabo L 120 x P 50 cm / for washbasin units W 120 x D 50 cm / base lavabo L 120 x P 50 cm

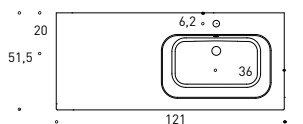

Art. **A373** (vasca DX) - Art. **A374** (vasca SX) P. 272



## Qubo 121 doppia vasca / twin sink / double vasque

Consolle H 1,5 cm (con foro troppo pieno)  
H 1,5 cm console (with overflow)  
Consolle H 1,5 cm (avec trop-plein)

**Ceramica / ceramic / céramique**

Vasche L 51 x P 32 x H 12,5 cm / interior W 51 x D 32 x H 12,5 cm / vasque int. L 51 x P 32 x H 12,5 cm  
Per basi portlavabo L 120 x P 50 cm / for washbasin units W 120 x D 50 cm / base lavabo L 120 x P 50 cm

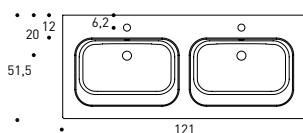

Art. **A735** - P. 272



## Qubo 141 doppia vasca / twin sink / double vasque

Consolle H 1,5 cm (con foro troppo pieno)  
H 1,5 cm console (with overflow)  
Consolle H 1,5 cm (avec trop-plein)

**Ceramica / ceramic / céramique**

Vasche L 55 x P 32 x H 12,5 cm / interior W 55 x D 32 x H 12,5 cm / vasque int. L 55 x P 32 x H 12,5 cm  
Per basi portlavabo L 140 x P 50 cm / for washbasin units W 140 x D 50 cm / base lavabo L 140 x P 50 cm

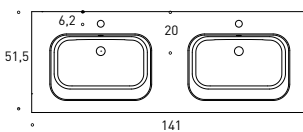

Art. **A375** - P. 273





# Tak

ceramica/ceramic/c ramique



## Tak 70

Consolle H 3,5 cm (con foro troppo pieno, compreso di piletta Stop & Go in ceramica)  
H 3,5 cm console (with overflow, including Stop &Go ceramic plug)  
Consolle H 3,5 cm (avec trop-plein, avec bonde Stop & Go en c ramique)

**Ceramica / ceramic / c ramique**  
Vasca L 56 x P 37 x H 12,5 cm / interior W 56 x D 37 x H 12,5 cm / vasque int. L 56 x P 37 x H 12,5 cm  
Per basi portlavabo L 70 x P 50 cm / for washbasin units W 70 x D 50 cm / base lavabo L 70 x P 50 cm

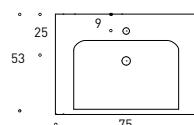

Art. **A376** - P. 273

## Tak 85

Consolle H 3,5 cm (con foro troppo pieno, compreso di piletta Stop & Go in ceramica)  
H 3,5 cm console (with overflow, including Stop &Go ceramic plug)  
Consolle H 3,5 cm (avec trop-plein avec bonde Stop & Go en c ramique)

**Ceramica / ceramic / c ramique**  
Vasca L 66 x P 37 x H 12,5 cm / interior W 66 x D 37 x H 12,5 cm / vasque int. L 66 x P 37 x H 12,5 cm  
Per basi portlavabo L 85 x P 50 cm / for washbasin units W 85 x D 50 cm / base lavabo L 85 x P 50 cm

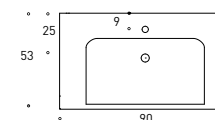

Art. **A377** - P. 273

## Tak 95

Consolle H 3,5 cm (con foro troppo pieno, compreso di piletta Stop & Go in ceramica)  
H 3,5 cm console (with overflow, including Stop &Go ceramic plug)  
Consolle H 3,5 cm (avec trop-plein avec bonde Stop & Go en c ramique)

**Ceramica / ceramic / c ramique**  
Vasca L 66 x P 37 x H 12,5 cm / interior W 66 x D 37 x H 12,5 cm / vasque int. L 66 x P 37 x H 12,5 cm  
Per basi portlavabo L 95 x P 50 cm / for washbasin units W 95 x D 50 cm / base lavabo L 95 x P 50 cm

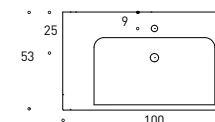

Art. **A378** - P. 273

## Tak 105

Consolle H 3,5 cm (con foro troppo pieno, compreso di piletta Stop & Go in ceramica)  
H 3,5 cm console (with overflow, including Stop &Go ceramic plug)  
Consolle H 3,5 cm (avec trop-plein avec bonde Stop & Go en c ramique)

**Ceramica / ceramic / c ramique**  
Vasca L 66 x P 37 x H 12,5 cm / interior W 66 x D 37 x H 12,5 cm / vasque int. L 66 x P 37 x H 12,5 cm  
Per basi portlavabo L 105 x P 50 cm / for washbasin units W 105 x D 50 cm / base lavabo L 105 x P 50 cm

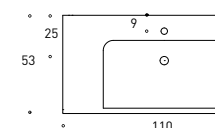

Art. **A379** - P. 273

## Tak 105 dx-sx / rh-lh / dr-ga

Consolle H 3,5 cm (con foro troppo pieno, compreso di piletta Stop & Go in ceramica)  
H 3,5 cm console (with overflow, including Stop &Go ceramic plug)  
Consolle H 3,5 cm (avec trop-plein avec bonde Stop & Go en c ramique)

**Ceramica / ceramic / c ramique**  
Vasca L 59 x P 37 x H 12,5 cm / interior W 59 x D 37 x H 12,5 cm / vasque int. L 59 x P 37 x H 12,5 cm  
Per basi portlavabo L 105 x P 50 cm / for washbasin units W 105 x D 50 cm / base lavabo L 105 x P 50 cm

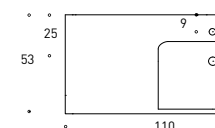

Art. **A380** (vasca DX) - Art. **A386** (vasca SX) P. 273

# Toy

ceramica/ceramic/c eramique



## Toy 51

Consolle H 5 cm (con foro troppo pieno)  
H 5 cm console (with overflow)  
Consolle H 5 cm (avec trop-plein)

Ceramica / ceramic / c eramique  
Vasca L 40 x P 30,5 x H 15 cm / interior W 40 x D 30,5 x H 15 cm / vasque int. L 40 x P 30,5 x H 15 cm  
Per basi portlavabo L 50 x P 50 cm / for washbasin units W 50 x D 50 cm / base lavabo L 50 x P 50 cm

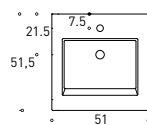

Art. **A576** - P. 273



## Toy 71

Consolle H 5 cm (con foro troppo pieno)  
H 5 cm console (with overflow)  
Consolle H 5 cm (avec trop-plein)

Ceramica / ceramic / c eramique  
Vasca L 56 x P 31 x H 15 cm / interior W 56 x D 31 x H 15 cm / vasque int. L 56 x P 31 x H 15 cm  
Per basi portlavabo L 70 x P 50 cm / for washbasin units W 70 x D 50 cm / base lavabo L 70 x P 50 cm

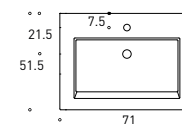

Art. **A581** - P. 273



## Toy 86

Consolle H 5 cm (con foro troppo pieno)  
H 5 cm console (with overflow)  
Consolle H 5 cm (avec trop-plein)

Ceramica / ceramic / c eramique  
Vasca L 55 x P 31 x H 13 cm / interior W 55 x D 31 x H 13 cm / vasque int. L 55 x P 31 x H 13 cm  
Per basi portlavabo L 85 x P 50 cm / for washbasin units W 85 x D 50 cm / base lavabo L 85 x P 50 cm

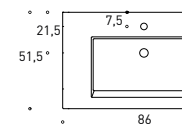

Art. **A582** - P. 274



## Toy 96

Consolle H 5 cm (con foro troppo pieno)  
H 5 cm console (with overflow)  
Consolle H 5 cm (avec trop-plein)

Ceramica / ceramic / c eramique  
Vasca L 70 x P 31 x H 13 cm / interior W 70 x D 31 x H 13 cm / vasque int. L 70 x P 31 x H 13 cm  
Per basi portlavabo L 95 x P 50 cm / for washbasin units W 95 x D 50 cm / base lavabo L 95 x P 50 cm

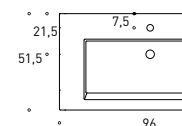

Art. **A583** - P. 274



## Toy 106

Consolle H 5 cm (con foro troppo pieno)  
H 5 cm console (with overflow)  
Consolle H 5 cm (avec trop-plein)

Ceramica / ceramic / c eramique  
Vasca L 70 x P 31 x H 13 cm / interior W 70 x D 31 x H 13 cm / vasque int. L 70 x P 31 x H 13 cm  
Per basi portlavabo L 105 x P 50 cm / for washbasin units W 105 x D 50 cm / base lavabo L 105 x P 50 cm

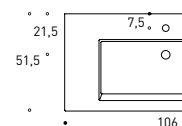

Art. **A584** - P. 274

# Spa

ceramica/ceramic/c ramique



## Spa 86

Consolle H 1,5 cm (con foro troppo pieno)  
H 1,5 cm console (with overflow)  
Consolle H 1,5 cm (avec trop-plein)

Ceramica / ceramic /  ramique  
Vasca L 66 x P 31 x H 13 cm / interior W 66 x D 31 x H 13 cm / vasque int. L 66 x P 31 x H 13 cm  
Per basi port lavabo L 85 x P 50 cm / for washbasin units W 85 x D 50 cm / base lavabo L 85 x P 50 cm

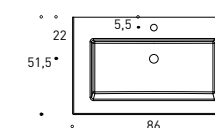

Art. **A127** - P. 274



## Spa 96

Consolle H 1,5 cm (con foro troppo pieno)  
H 1,5 cm console (with overflow)  
Consolle H 1,5 cm (avec trop-plein)

Ceramica / ceramic /  ramique  
Vasca L 76 x P 31 x H 13 cm / interior W 76 x D 31 x H 13 cm / vasque int. L 76 x P 31 x H 13 cm  
Per basi port lavabo L 95 x P 50 cm / for washbasin units W 95 x D 50 cm / base lavabo L 95 x P 50 cm

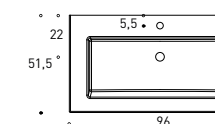

Art. **A128** - P. 274



## Spa 106

Consolle H 1,5 cm (con foro troppo pieno)  
H 1,5 cm console (with overflow)  
Consolle H 1,5 cm (avec trop-plein)

Ceramica / ceramic /  ramique  
Vasca L 87 x P 31 x H 13 cm / interior W 87 x D 31 x H 13 cm / vasque int. L 87 x P 31 x H 13 cm  
Per basi port lavabo L 105 x P 50 cm / for washbasin units W 105 x D 50 cm / base lavabo L 105 x P 50 cm

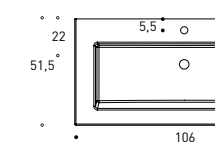

Art. **A129** - P. 274



## Spa 121

Consolle H 1,5 cm (con foro troppo pieno)  
H 1,5 cm console (with overflow)  
Consolle H 1,5 cm (avec trop-plein)

Ceramica / ceramic /  ramique  
Vasca L 102 x P 31 x H 13 cm / interior W 102 x D 31 x H 13 cm / vasque int. L 102 x P 31 x H 13 cm  
Per basi port lavabo L 120 x P 50 cm / for washbasin units W 120 x D 50 cm / base lavabo L 120 x P 50 cm

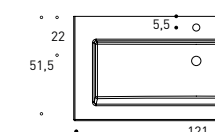

Art. **A130** - P. 274



## Spa 71

Consolle H 1,5 cm (con foro troppo pieno)  
H 1,5 cm console (with overflow)  
Consolle H 1,5 cm (avec trop-plein)

Ceramica / ceramic /  ramique  
Vasca L 50,5 x P 31 x H 13 cm / interior W 50,5 x D 31 x H 13 cm / vasque int. L 50,5 x P 31 x H 13 cm  
Per basi port lavabo L 70 x P 50 cm / for washbasin units W 70 x D 50 cm / base lavabo L 70 x P 50 cm

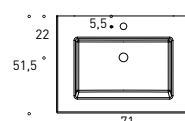

Art. **A126** - P. 274



# Melody

ceramica/ceramic/c eramique



## Melody 72

Consolle H 1,5 cm (con foro troppo pieno)  
H 1,5 cm console (with overflow)  
Consolle H 1,5 cm (avec trop-plein)

**Ceramica / ceramic / c eramique**  
Vasca L 53,5 x P 32,5 x H 13 cm / interior W 53,5 x D 32,5 x H 13 cm / vasque int. L 53,5 x P 32,5 x H 13 cm  
Per basi port lavabo L 70 x P 50 cm / for washbasin units W 70 x D 50 cm / base lavabo L 70 x P 50 cm

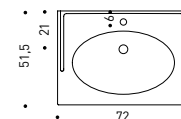

Art. **A217** - P. 275



## Melody 107

Consolle H 1,5 cm (con foro troppo pieno)  
H 1,5 cm console (with overflow)  
Consolle H 1,5 cm (avec trop-plein)

**Ceramica / ceramic / c eramique**  
Vasca L 61 x P 32,5 x H 13 cm / interior W 61 x D 32,5 x H 13 cm / vasque int. L 61 x P 32,5 x H 13 cm  
Per basi port lavabo L 105 x P 50 cm / for washbasin units W 105 x D 50 cm / base lavabo L 105 x P 50 cm

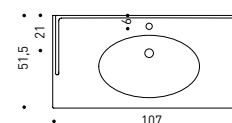

Art. **A218** - P. 275



## Melody 122

Consolle H 1,5 cm (con foro troppo pieno)  
H 1,5 cm console (with overflow)  
Consolle H 1,5 cm (avec trop-plein)

**Ceramica / ceramic / c eramique**  
Vasca L 67 x P 32,5 x H 13 cm / interior W 67 x D 32,5 x H 13 cm / vasque int. L 67 x P 32,5 x H 13 cm  
Per basi port lavabo L 120 x P 50 cm / for washbasin units W 120 x D 50 cm / base lavabo L 120 x P 50 cm

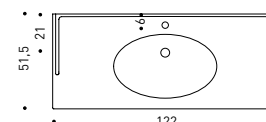

Art. **A219** - P. 275

# Lego

mineralguss/mineralguss/mineralguss



## Lego 61

Consolle H 5 cm (con foro troppo pieno)  
H 5 cm console (with overflow)  
Consolle H 5 cm (avec trop-plein)

Mineralguss / mineralguss / mineralguss  
Vasca L 50 x P 31 x H 12 cm / interior W 50 x D 31 x H 12 cm / vasque int. L 50 x P 31 x H 12 cm  
Per basi portalavabo L 60 x P 50 cm / for washbasin units W 60 x D 50 cm / base lavabo L 60 x P 50 cm

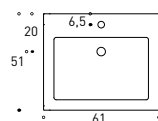

Art. **A526** - P. 276



## Lego 71

Consolle H 5 cm (con foro troppo pieno)  
H 5 cm console (with overflow)  
Consolle H 5 cm (avec trop-plein)

Mineralguss / mineralguss / mineralguss  
Vasca L 60 x P 31 x H 12 cm / interior W 60 x D 31 x H 12 cm / vasque int. L 60 x P 31 x H 12 cm  
Per basi portalavabo L 70 x P 50 cm / for washbasin units W 70 x D 50 cm / base lavabo L 70 x P 50 cm

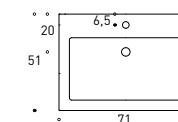

Art. **A527** - P. 276



## Lego 86

Consolle H 5 cm (con foro troppo pieno)  
H 5 cm console (with overflow)  
Consolle H 5 cm (avec trop-plein)

Mineralguss / mineralguss / mineralguss  
Vasca L 75 x P 31 x H 12 cm / interior W 75 x D 31 x H 12 cm / vasque int. L 75 x P 31 x H 12 cm  
Per basi portalavabo L 85 x P 50 cm / for washbasin units W 85 x D 50 cm / base lavabo L 85 x P 50 cm

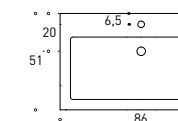

Art. **A528** - P. 276



## Lego 96

Consolle H 5 cm (con foro troppo pieno)  
H 5 cm console (with overflow)  
Consolle H 5 cm (avec trop-plein)

Mineralguss / mineralguss / mineralguss  
Vasca L 85 x P 31 x H 12 cm / interior W 85 x D 31 x H 12 cm / vasque int. L 85 x P 31 x H 12 cm  
Per basi portalavabo L 95 x P 50 cm / for washbasin units W 95 x D 50 cm / base lavabo L 95 x P 50 cm

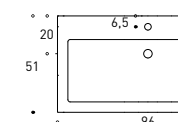

Art. **A529** - P. 276

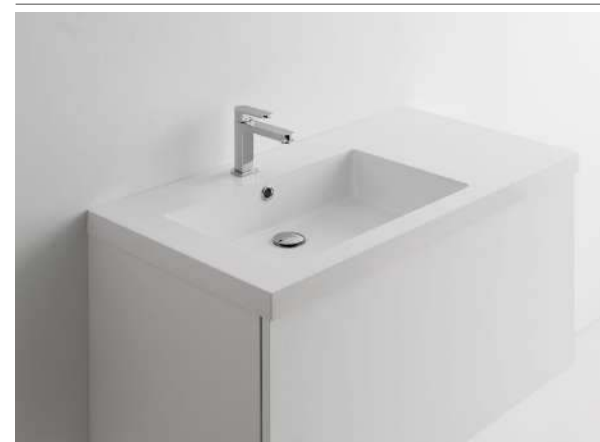

## Lego 96 dx-sx / rh-lh / dr-ga

Consolle H 5 cm (con foro troppo pieno)  
H 5 cm console (with overflow)  
Consolle H 5 cm (avec trop-plein)

Mineralguss / mineralguss / mineralguss  
Vasca L 60 x P 33 x H 12 cm / interior W 60 x D 33 x H 12 cm / vasque int. L 60 x P 33 x H 12 cm  
Per basi portalavabo L 95 x P 50 cm / for washbasin units L 95 x P 50 cm / base lavabo L 95 x P 50 cm

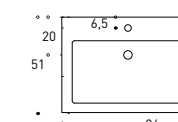

Art. **A539** (vasca DX) - Art. **A540** (vasca SX) P. 276



## Lego 106

Consolle H 5 cm (con foro troppo pieno)  
H 5 cm console (with overflow)  
Consolle H 5 cm (avec trop-plein)

**Mineralguss / mineralguss / mineralguss**  
Vasca L 95 x P 33 x H 12 cm / interior W 95 x D 33 x H 12 cm / vasque int. L 95 x P 33 x H 12 cm  
Per basi portalavabo L 105 x P 50 cm / for washbasin units W 105 x D 50 cm / base lavabo L 105 x P 50 cm

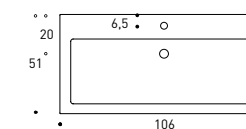

Art. **A530** - P. 276



## Lego 121 doppia vasca / twin sink / double vasque

Consolle H 5 cm (con foro troppo pieno)  
H 5 cm console with double basin (with overflow)  
Consolle H 5 cm avec double vasque (avec trop-plein)

**Mineralguss / mineralguss / mineralguss**  
Vasche L 50 x P 33 x H 12 cm / interior W 50 x D 33 x H 12 cm / vasque int. L 50 x P 33 x H 12 cm  
Per basi portalavabo L 60+60 / L 120 x P 50 cm / for washbasin units W 60+60 / W 120 x D 50 cm / base lavabo L 60+60 / L 120 x P 50 cm

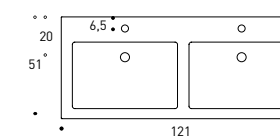

Art. **A532** - P. 276



## Lego 141 doppia vasca / twin sink / double vasque

Consolle H 5 cm (con foro troppo pieno)  
H 5 cm console with double basin (with overflow)  
Consolle H 5 cm avec double vasque (avec trop-plein)

**Mineralguss / mineralguss / mineralguss**  
Vasche L 60 x P 33 x H 12 cm / interior W 60 x D 33 x H 12 cm / vasque int. L 60 x P 33 x H 12 cm  
Per basi portalavabo L 70+70/140 x P 50 cm / for washbasin units W 70+70/140 x D 50 cm / base lavabo L 70+70/140 x P 50 cm

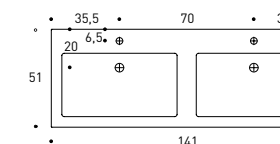

Art. **A531** - P. 276

# Curvy

mineralguss/mineralguss/mineralguss



## Curvy 71

Consolle H 1,2 cm (con foro troppo pieno)  
H 1,2 cm console (with overflow)  
Consolle H 1,2 cm (avec trop-plein)

Mineralguss / mineralguss / mineralguss  
Vasca L 50 x P 31 x H 12 cm / interior W 50 x D 31 x H 12 cm / vasque int. L 50 x P 31 x H 12 cm  
Per basi portlavabo L 70 x P 50 cm / for washbasin units W 70 x D 50 cm / base lavabo L 70 x P 50 cm

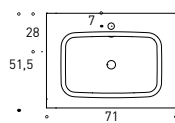

Art. **A381** - P. 277

## Curvy 86

Consolle H 1,2 cm (con foro troppo pieno)  
H 1,2 cm console (with overflow)  
Consolle H 1,2 cm (avec trop-plein)

Mineralguss / mineralguss / mineralguss  
Vasca L 50 x P 31 x H 12 cm / interior W 50 x D 31 x H 12 cm / vasque int. L 50 x P 31 x H 12 cm  
Per basi portlavabo L 85 x P 50 cm / for washbasin units W 85 x D 50 cm / base lavabo L 85 x P 50 cm

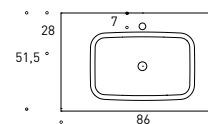

Art. **A382** - P. 277

## Curvy 96

Consolle H 1,2 cm (con foro troppo pieno)  
H 1,2 cm console (with overflow)  
Consolle H 1,2 cm (avec trop-plein)

Mineralguss / mineralguss / mineralguss  
Vasca L 50 x P 31 x H 12 cm / interior W 50 x D 31 x H 12 cm / vasque int. L 50 x P 31 x H 12 cm  
Per basi portlavabo L 95 x P 50 cm / for washbasin units W 95 x D 50 cm / base lavabo L 95 x P 50 cm

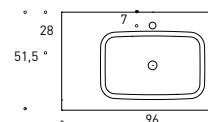

Art. **A383** - P. 277

## Curvy 106

Consolle H 1,2 cm (con foro troppo pieno)  
H 1,2 cm console (with overflow)  
Consolle H 1,2 cm (avec trop-plein)

Mineralguss / mineralguss / mineralguss  
Vasca L 50 x P 31 x H 12 cm / interior W 50 x D 31 x H 12 cm / vasque int. L 50 x P 31 x H 12 cm  
Per basi portlavabo L 105 x P 50 cm / for washbasin units W 105 x D 50 cm / base lavabo L 105 x P 50 cm

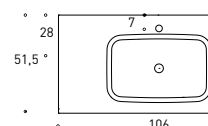

Art. **A384** - P. 277

## Curvy 121

Consolle H 1,2 cm (con foro troppo pieno)  
H 1,2 cm console (with overflow)  
Consolle H 1,2 cm (avec trop-plein)

Mineralguss / mineralguss / mineralguss  
Vasca L 50 x P 31 x H 12 cm / interior W 50 x D 31 x H 12 cm / vasque int. L 50 x P 31 x H 12 cm  
Per basi portlavabo L 120 x P 50 cm / for washbasin units W 120 x D 50 cm / base lavabo L 120 x P 50 cm

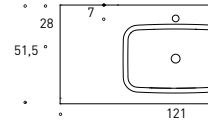

Art. **A385** - P. 277



# Rodi

mineralguss/mineralguss/mineralguss



## Rodi 71

Consolle H 1,2 cm (senza foro troppo pieno)  
Th. 1,2 cm console (without overflow)  
Consolle H 1,2 cm (sans trop-plein)

Mineralguss / mineralguss / mineralguss  
Vasca L 60 x P 30 x H 9 cm / interior W 60 x D 30 x H 9 cm / vasque int. L 60 x P 30 x H 9 cm  
Per basi portlavabo L 70 x P 50 cm / for washbasin units W 70 x D 50 cm / base lavabo L 70 x P 50 cm

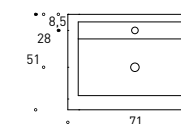

Art. **A438** - P. 277



## Rodi 86

Consolle H 1,2 cm (senza foro troppo pieno)  
Th. 1,2 cm console (without overflow)  
Consolle H 1,2 cm (sans trop-plein)

Mineralguss / mineralguss / mineralguss  
Vasca L 60 x P 30 x H 9 cm / interior W 60 x D 30 x H 9 cm / vasque int. L 60 x P 30 x H 9 cm  
Per basi portlavabo L 85 x P 50 cm / for washbasin units W 85 x D 50 cm / base lavabo L 85 x P 50 cm

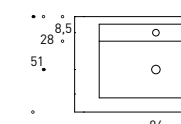

Art. **A439** - P. 277



## Rodi 96

Consolle H 1,2 cm (senza foro troppo pieno)  
Th. 1,2 cm console (without overflow)  
Consolle H 1,2 cm (sans trop-plein)

Mineralguss / mineralguss / mineralguss  
Vasca L 60 x P 30 x H 9 cm / interior W 60 x D 30 x H 9 cm / vasque int. L 60 x P 30 x H 9 cm  
Per basi portlavabo L 95 x P 50 cm / for washbasin units W 95 x D 50 cm / base lavabo L 95 x P 50 cm

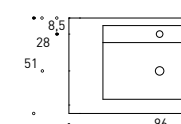

Art. **A450** - P. 277





## Kreo

Piano top sp. 1,2 cm (senza foro troppo pieno)  
Th. 1,2 cm top (without overflow)  
Plan de toilette H 1,2 cm (sans trop-plein)

Vasca L 59,6 x P 35 x H 13 cm / interior W 59,6 x D 35 x H 13 cm /  
vasque int. L 59,6 x P 35 x H 13 cm

Per basi portalavabo min. L 70 x P 37 cm / for washbasin units min.  
W 70 x D 37 cm / base lavabo L 70 x P 37 cm

Finiture / finishes / finitions:

mineralguss:



bianco

tekno:



bianco



## Loft

Piani top sp. 1,5 cm (senza foro troppo pieno)  
Th. 1,5 cm top (without overflow)  
Plan de toilette H 1,5 cm (sans trop-plein)

Vasca L 60 x P 32 x H 14 cm / interior W 60 x D 32 x H 14 cm /  
vasque int. L 60 x P 32 x H 14 cm

Per basi portalavabo min. L 70 x P 37 cm / for washbasin units min.  
W 70 x D 37 cm / base lavabo L 70 x P 37 cm

Finiture / finishes / finitions:

mineralguss / mineralguss / mineralguss



bianco

### Art. A197

Per mobile da L 70 a 140 cm  
con vasca dx-sx

P. 279

### Art. A198

Per mobile da L 70 a 140 cm  
con vasca centrale

P. 279

### Art. A199

Per mobile da L 70 a 170 cm  
solo vasca centrale

P. 279

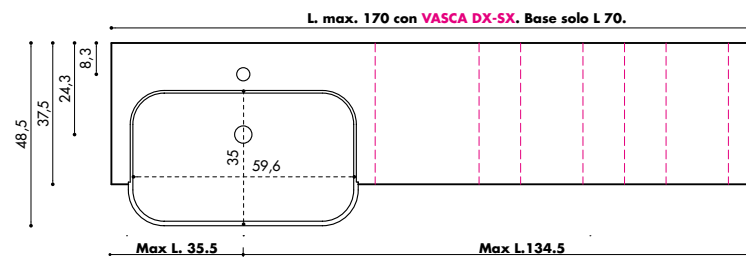

### Art. F007

Per mobile da L 70 a 110 cm  
con vasca dx-sx

P. 278

### Art. F008

Per mobile da L 111 a 140 cm  
con vasca dx-sx

P. 278

### Art. F009

Per mobile da L 141 a 170 cm  
con vasca dx-sx

P. 278

### Art. F010

Per mobile da L 70 a 170 cm  
solo vasca centrale

P. 278

### Art. F011

Per mobile da L 171 a 210 cm  
solo vasca centrale

P. 278

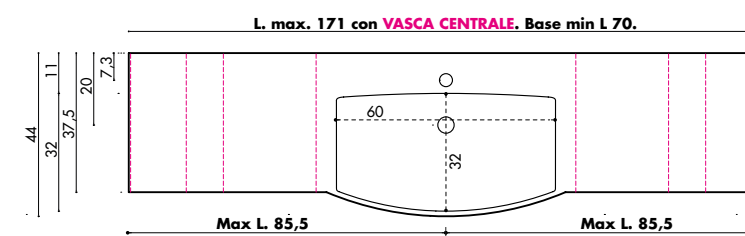
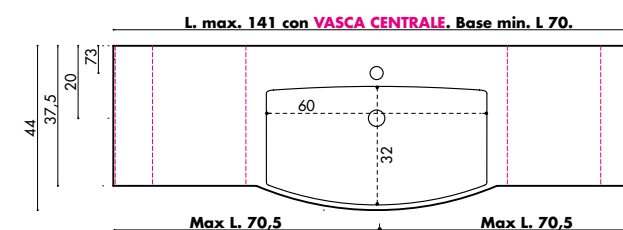
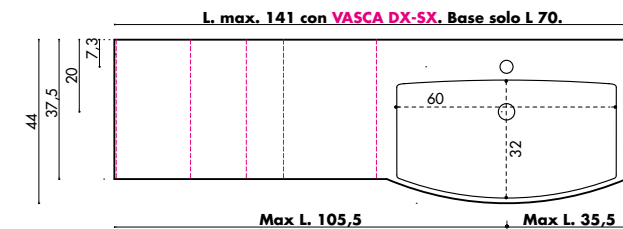
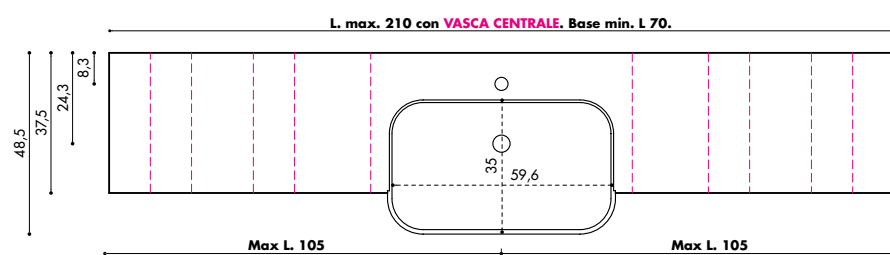



## Joy

Piani top sp. 1,4 cm (con foro troppo pieno)  
Th. 1,4 cm tops (with overflow)  
Plan de toilette top H 1,4 cm (avec trop-plein)

Mineralguss / mineralguss / mineralguss  
Vasca L 60 x P 33 x H 14 cm / interior W 60 x D 33 x H 14 cm / vasque int. L 60 x P 33 x H 14 cm

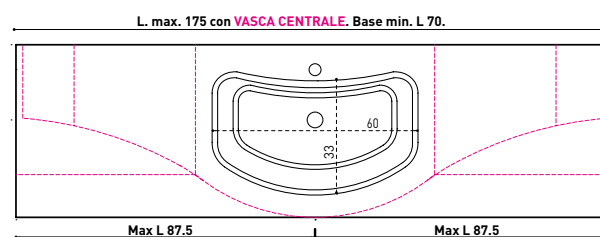

Art. **F701**  
Per basi portalavabo  
min. L 70 x P 50 cm  
P. 281

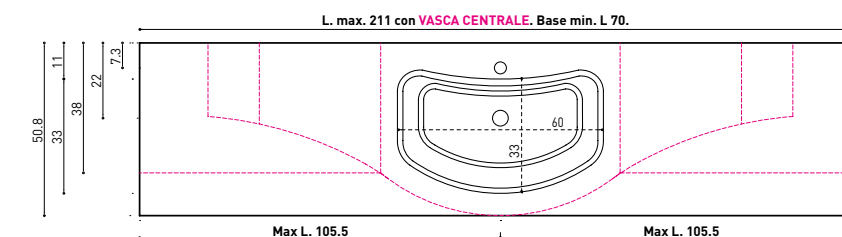

Art. **F801**  
Per basi portalavabo  
min. L 70 x P 50 cm  
P. 281



## Joker

Piano top sp. 1,4 cm (con foro troppo pieno)  
Th. 1,4 cm tops (with overflow)  
Plan de toilette H 1,4 cm (avec trop-plein)

Mineralguss / mineralguss / mineralguss  
Vasca L 77 x P 33 x H 14 cm / interior W 77 x D 33 x H 14 cm / vasque int. L 77 x P 33 x H 14 cm

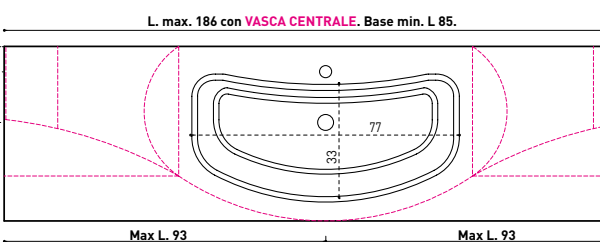

Art. **F702**  
Per basi portalavabo  
min. L 85 x P 50 cm  
P. 281

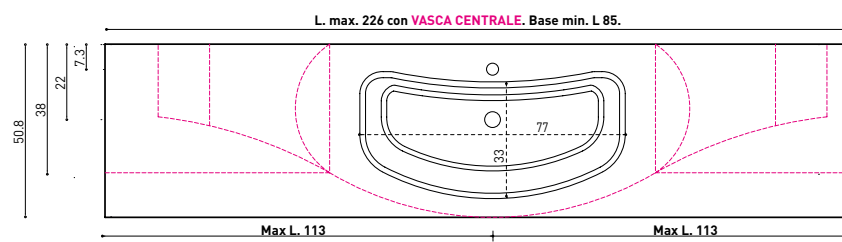

Art. **F802**  
Per basi portalavabo  
min. L 85 x P 50 cm  
P. 281



## Slim

Piani top sp. 3,5 cm (con foro troppo pieno e set da installare)  
Th. 3,5 cm tops (with overflow and set to be installed)  
Plan de toilette H 3,5 cm (avec trop-plein et kit à installer)

Mineralguss / mineralguss / mineralguss  
Vasca L 70 x P 35 x H 14 cm / interior W70 x D 35 x H 14 cm /  
vasque int. L 70 x P 35 x H 14 cm



## Rodi

Piani top sp. 1,2 cm (senza foro troppo pieno)  
Th. 1,2 cm top (without overflow)  
Plan de toilette H 1,2 cm (sans trop-plein)

Per basi portalavabo min. L 70 x P 50 cm /  
for washbasin units min. W 70 x D 50 cm /  
base lavabo L 70 x P 50 cm

Mineralguss / mineralguss / mineralguss  
Vasca L 60 x P 30 x H 8 cm / interior W 60 x D 30 x H 8 cm /  
vasque int. L 60 x P 30 x H 8 cm

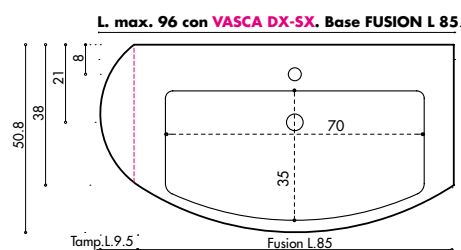

Art. **F309**  
Per basi portalavabo  
Fusion L 85 cm  
P. 280

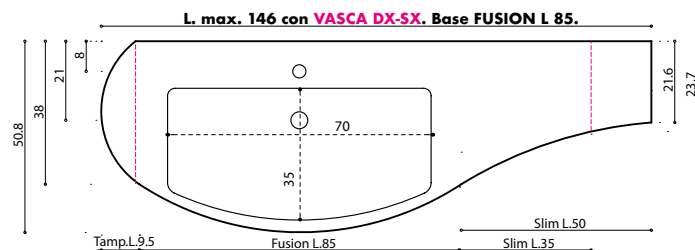

Art. **F308**  
Per basi portalavabo  
Fusion L 85 cm  
P. 280

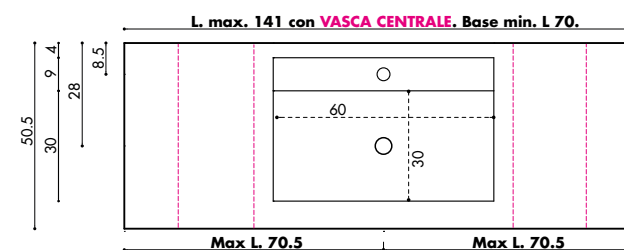

Art. **F294** - P. 282

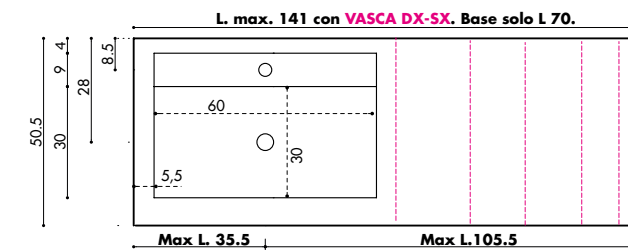

Art. **F295** - P. 282



## Zero

Piano top sp. 2,3 cm (con foro troppo pieno e set da installare)  
Th. 2,3 cm tops (with overflow and set to be installed)  
Plan de toilette H 2,3 cm (avec trop-plein et kit à installer)

Mineralguss / mineralguss / mineralguss  
Vasca L 70 x P 35 x H 14 cm / interior W 70 x D 35 x H 14 cm /  
vasque int. L 70 x P 35 x H 14 cm



## Naxos

Piani top sp. 1,2 cm (senza foro troppo pieno)  
Th. 1,2 cm top (without overflow)  
Plan de toilette H 1,2 cm (sans trop-plein)

Per basi portalavabo min. L 70 x P 50 cm /  
for washbasin units min. W 70 x D 50 cm /  
pour éléments bas sous- lavabo L 70 x P 50 cm

Vasca L 60 x P 31 x H 10 cm / interior W 60 x D 31 x H 10 cm /  
vasque int. L 60 x P 31 x H 10 cm

Finiture / finishes / finitions:

tekno

mineralguss



bianco



bianco

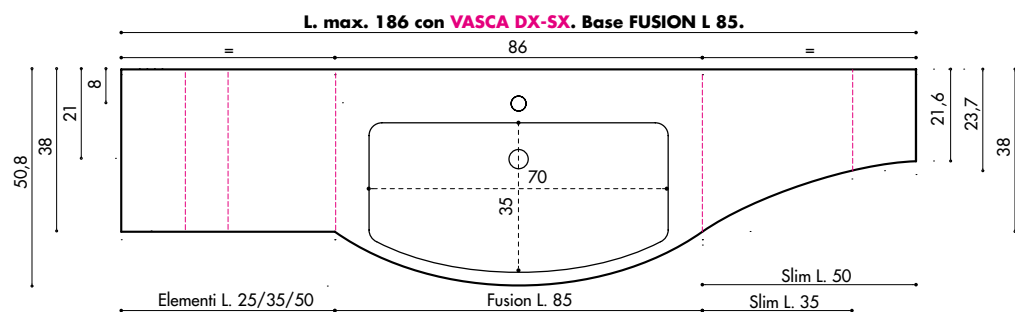

Art. **F002**  
Per basi portalavabo  
Fusion L 85 cm  
P. 280

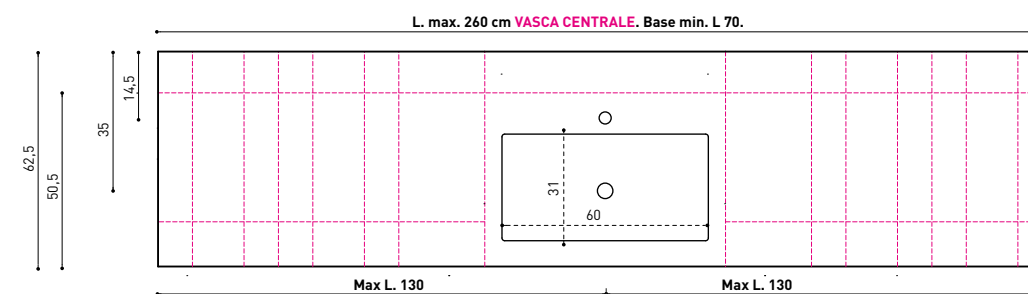

Art. **F372** - P. 282  
Per mobile da L 70 a 105 cm  
Art. **F373** - P. 282  
Per mobile da L 106 a 140 cm  
Art. **F374** - P. 282  
Per mobile da L 141 a 170 cm  
Art. **F375** - P. 282  
Per mobile da L 171 a 190 cm  
Art. **F376** - P. 282  
Per mobile da L 191 a 220 cm  
Art. **F377** - P. 282  
Per mobile da L 221 a 260 cm



## Curvy

Piani top sp. 1,2 cm (senza foro troppo pieno)  
Th. 1,2 cm top (without overflow)  
Plan de toilette H 1,2 cm (sans trop-plein)

Per basi portalavabo min. L 60 x P 50 cm /  
for washbasin units min. W 60 x D 50 cm /  
élément bas sous-lavabo L 60 x P 50 cm

Vasca L 51 x P 31 x H 12,5 cm  
interior W 51 x D 31 x H 12,5 cm  
vasque int. L 51 x P 31 x H 12,5 cm

Finiture / finishes / finitions:

mineralguss:



bianco

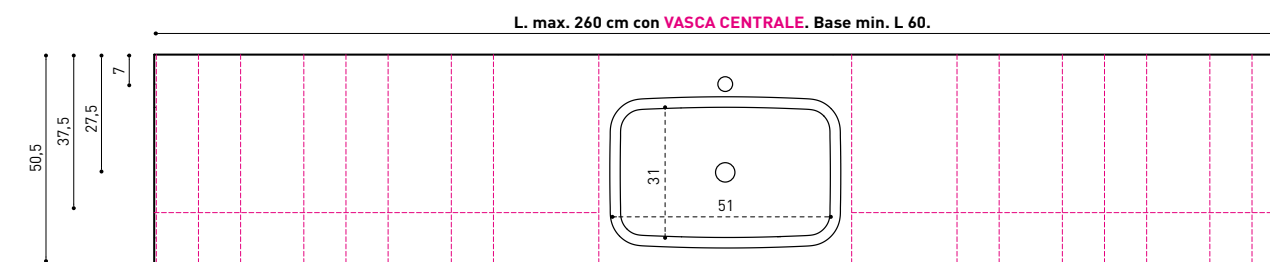

## Curvy sp. 1,2 cm

vasca singola  
one sink / 1 vasque

Art. **F257** - P. 283  
Per mobile da L 60 a 105 cm

Art. **F258** - P. 283  
Per mobile da L 106 a 140 cm

Art. **F259** - P. 283  
Per mobile da L 141 a 170 cm

Art. **F260** - P. 283  
Per mobile da L 171 a 190 cm

Art. **F261** - P. 283  
Per mobile da L 191 a 220 cm

Art. **F262** - P. 283  
Per mobile da L 221 a 260 cm

vasca doppia  
twin sink / double vasque

Art. **F263** - P. 283  
Per mobile da L 120 a 170 cm

Art. **F264** - P. 283  
Per mobile da L 171 a 190 cm

Art. **F265** - P. 283  
Per mobile da L 191 a 220 cm

Art. **F266** - P. 283  
Per mobile da L 221 a 260 cm



## Small

Piani top sp. 1,2, 8 e 12,2 cm (senza foro troppo pieno)  
Th. 1,2, 8 and 12,2 cm top (without overflow)  
Plan de toilette H 1,2, 8 et 12,2 cm (sans trop-plein)

Per basi portalavabo min. L 60 x P 37 cm /  
for washbasin units min. W 60 x D 37 cm /  
élément bas sous-lavabo L 60 x P 37 cm

Vasca L 52 x P 24,5 x H 11 cm / interior W 52 x D 24,5 x H 11 cm /  
vasque int. L 52 x P 24,5 x H 11 cm

Finiture / finishes / finitions:

mineralguss:



bianco

tekno:



bianco

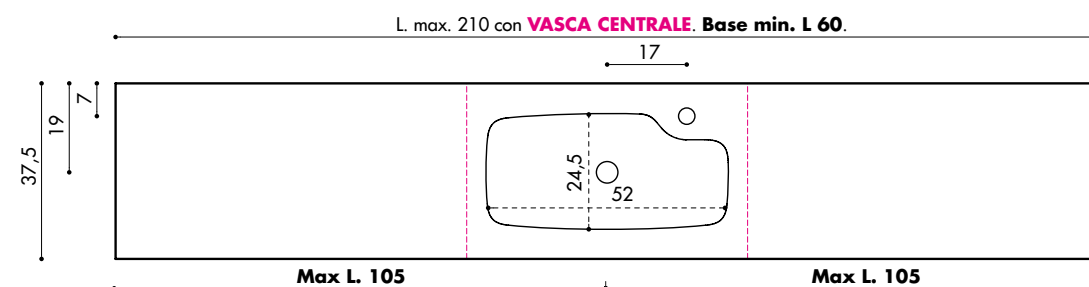

## Small sp. 1,2 cm

Piani top sp. 1,2 cm (senza foro troppo pieno)  
Th. 1,2 cm top (without overflow)  
Plan de toilette H 1,2 cm (sans trop-plein)

Vasca L 52 x P 24,5 x H 11 cm / interior W 52 x D 24,5 x H 11 cm / vasque int. L 52 x P 24,5 x H 11 cm

vasca singola  
one sink / 1 vasque

Art. **F012** - P. 287  
Per mobile da L 60 a 105 cm

Art. **F013** - P. 287  
Per mobile da L 106 a 140 cm

Art. **F014** - P. 287  
Per mobile da L 141 a 170 cm

Art. **F015** - P. 287  
Per mobile da L 171 a 190 cm

Art. **F016** - P. 287  
Per mobile da L 191 a 210 cm

vasca doppia  
twin sink / double vasque

Art. **F017** - P. 287  
Per mobile da L 120 a 170 cm

Art. **F018** - P. 287  
Per mobile da L 171 a 190 cm

Art. **F019** - P. 287  
Per mobile da L 191 a 210 cm



## Small sp. 8 cm

Piani top sp. 8 cm (senza foro troppo pieno)  
Th. 8 cm top (without overflow)  
Plan de toilette H 8 cm (sans trop-plein)

Vasca L 52 x P 24,5 x H 11 cm / interior W 52 x D 24,5 x H 11 cm / vasque int. L 52 x P 24,5 x H 11 cm

vasca singola  
one sink / 1 vasque

Art. **F820** - P. 287  
Per mobile da L 70 a 105 cm

Art. **F821** - P. 287  
Per mobile da L 106 a 140 cm

Art. **F822** - P. 287  
Per mobile da L 141 a 170 cm

Art. **F823** - P. 287  
Per mobile da L 171 a 190 cm

Art. **F824** - P. 287  
Per mobile da L 191 a 210 cm

vasca doppia  
twin sink / double vasque

Art. **F825** - P. 287  
Per mobile da L 141 a 170 cm

Art. **F826** - P. 287  
Per mobile da L 171 a 190 cm

Art. **F827** - P. 287  
Per mobile da L 191 a 210 cm

**ATTENZIONE!** I piani top sp. 8 cm vanno sempre impiegati in appoggio dal momento che l'altezza della vasca supera lo spessore del piano / **NOTE!** The tops 8 cm thick must always be used as countertops when the height of the basin exceeds the depth of the top / **ATTENTION!** Les plans de toilette ép. 8 cm doivent toujours être posés quand la hauteur de la vasque dépasse l'épaisseur du plan.



## Small sp. 12,2 cm

Piani top sp. 12,2 cm (senza foro troppo pieno)  
Th. 12,2 cm top (without overflow)  
Plan de toilette H 12,2 cm (sans trop-plein)

Vasca L 52 x P 24,5 x H 11 cm / interior W 52 x D 24,5 x H 11 cm / vasque int. L 52 x P 24,5 x H 11 cm

vasca singola  
one sink / 1 vasque

Art. **F020** - P. 287  
Per mobile da L 70 a 105 cm

Art. **F021** - P. 287  
Per mobile da L 106 a 140 cm

Art. **F022** - P. 287  
Per mobile da L 141 a 170 cm

Art. **F023** - P. 287  
Per mobile da L 171 a 190 cm

Art. **F024** - P. 287  
Per mobile da L 191 a 210 cm

vasca doppia  
twin sink / double vasque

Art. **F025** - P. 287  
Per mobile da L 141 a 170 cm

Art. **F026** - P. 287  
Per mobile da L 171 a 190 cm

Art. **F027** - P. 287  
Per mobile da L 191 a 210 cm



# FINITURE / FINISHES / FINITIONS

**ATTENZIONE!** Per la reale tonalità delle finiture, fare riferimento al campionario.  
**/ FINISHES / FINITIONSNOTE!** For the actual shade of the finishes, refer to the samples.  
**ATTENTION!** Pour la réelle finition, faire référence à l'échantillon.

## CATEGORIA 1

### > MINERALGUSS



**Mineralguss**  
MG bianco lucido

## CATEGORIA 2

### > TEKNO > FENIX > HPL WOOD

**FENIX** NTM®

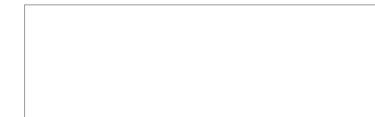

**Tekno**  
E1 bianco opaco

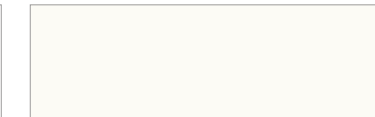

**FENIX**  
F0 Bianco Kos



**FENIX**  
F1 Grigio Efeso



**FENIX**  
F2 Castoro Ottawa



**FENIX**  
F3 Grigio Londra



**FENIX**  
F4 Grigio Bromo



**FENIX**  
F5 Bluriva



**HPL wood**  
FH Woody



**HPL wood**  
FI Cayman



**HPL wood**  
FJ Karbon

## CATEGORIA 3

### > LAMINAM



**Laminam**  
A9 Oxide Bianco



**Laminam**  
A5 Oxide Moro



**Laminam**  
A4 Oxide Nero



**Laminam**  
AF Pietra di Savoia Perla



**Laminam**  
AE Pietra di Savoia Grigia



**Laminam**  
AG Pietra di Savoia Antracite



**Laminam**  
AA Fokos Sale



**Laminam**  
AC Fokos Terra



**Laminam**  
AB Fokos Roccia

# FINITURE / FINISHES / FINITIONS

**ATTENZIONE!** Per la reale tonalità delle finiture, fare riferimento al campionario.  
**NOTE!** For the actual shade of the finishes, refer to the samples.  
**ATTENTION!** Pour la réelle finition, faire référence à l'échantillon.



**Laminam**  
AD Fokos Piombo



**Laminam**  
AD Ossidiana Vena  
Grigia



**Laminam**  
A8 Ossidiana Vena  
Scura



**Laminam**  
AH Emperador



**Laminam**  
AI Nero Greco opaco

## CATEGORIA 4 e PIANI SERRA

> GRES



**Iris**  
AJ Ivory



**Iris**  
AK Plumb



**Iris**  
AL Silver

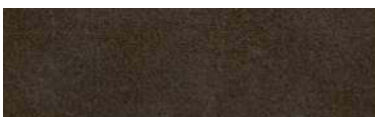

**Iris**  
AM Amber



**Iris**  
AN Calacatta opaco



**Iris**  
AO Bianco Venato opaco



**Iris**  
AP Gaudi Stone lucido

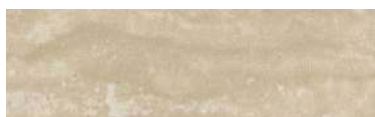

**Florim**  
AQ Travertino lucido

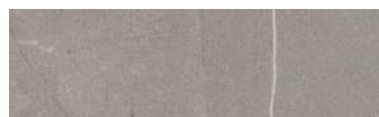

**Florim**  
AR Amani lucido





## Kuki e Plaza

Piani top sp. 1,2, 8 e 12,2 cm (senza foro troppo pieno)  
Th. 1,2, 8 and 12,2 cm tops (without overflow)  
Plan de toilette H 1,2, 8 et 12,2 cm (sans trop-plein)

### KUKI:

Vasca L 50 x P 31 x H 10 cm  
interior W 50 x D 31 x H 10 cm  
vasque int. L 50 x P 31 x H 10 cm

Per basi portalavabo min. L 60 x P 50 cm (per sp. 1,2 cm)  
L 70 x P 50 cm (per sp. 8 e 12,2 cm) /  
for washbasin units min. W 60 x D 50 cm (for 1,2 cm th.)  
W 70 x D 50 cm (for 8 and 12,2 cm th.) /  
Meuble S/lavabo L 60 x P 37 cm (pour ep. 1,2 cm)  
L 70 x P 50 cm (pour 8 et 12,2 cm)

### PLAZA:

Vasca L 70 x P 31 x H 10 cm  
interior W 70 x D 31 x H 10 cm  
vasque int. 70 x P 31 x H 10 cm

Per basi portalavabo min. L 85 x P 50 cm /  
for washbasin units min. W 85 x D 50 cm /  
meuble s/lavabo L 85 x P 50 cm

Finiture / finishes / finitions:

#### mineralguss:



bianco

#### tekno:



bianco

#### hpl wood:



cayman woody karbon

#### fenix:



bianco kos grigio efeso castoro ott. gr. londra gr. bromo bluriva

#### laminam:



sav. perla sav. grigia sav. antrac. fokus sale fokus terra fokus roccia fokus piombo emperador  
nero greco oss. v. grigia oss. v. scura oxide bianco oxide moro oxide nero

#### gres:

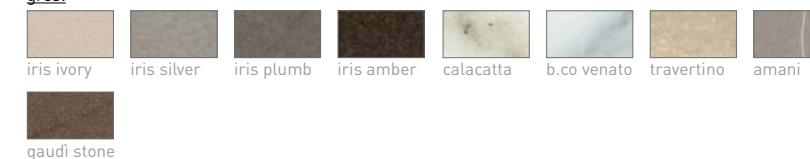

iris ivory iris silver iris plumb iris amber calacatta b.co venato travertino amani  
gaudi stone

#### KUKI:

L. max. 260 cm con **VASCA CENTRALE** per Mineralguss e Tekno. Base min. L 60.

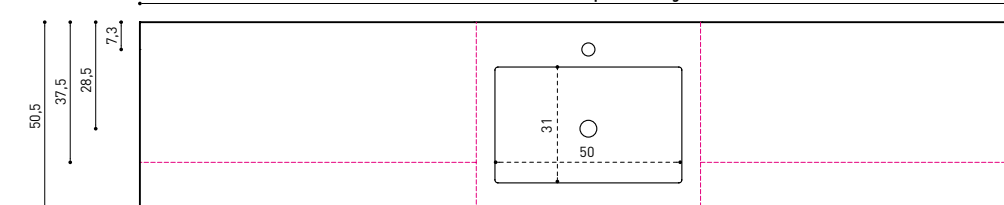

#### PLAZA:

L. max. 260 cm con **VASCA CENTRALE** per Mineralguss e Tekno. Base min. L 85.

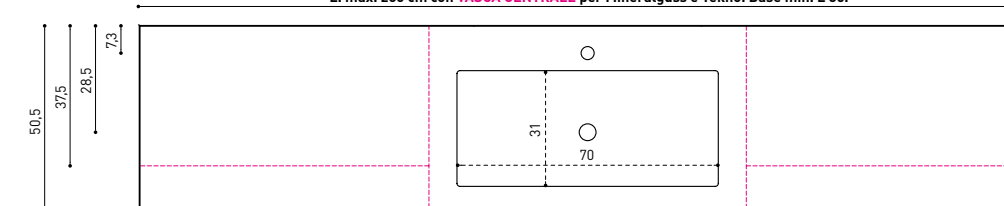





## Kuki sp. 1,2 cm

Piani top sp. 1,2 cm (senza foro troppo pieno)  
Th. 1,2 cm tops (without overflow)  
Plan de toilette H 1,2 cm (sans trop-plein)

Vasca L 50 x P 31 x H 10 cm / interior W 50 x D 31 x H 10 cm / vasque int. L 50 x P 31 x H 10 cm

vasca singola  
one sink / 1 vasque

Art. **F667** - P. 289  
Per mobile da L 60 a 105 cm

Art. **F668** - P. 289  
Per mobile da L 106 a 140 cm

Art. **F669** - P. 289  
Per mobile da L 141 a 170 cm

Art. **F670** - P. 289  
Per mobile da L 171 a 190 cm

Art. **F671** - P. 289  
Per mobile da L 191 a 220 cm

Art. **F672** - P. 289  
Per mobile da L 221 a 260 cm

vasca doppia  
twin sink / double vasque

Art. **F703** - P. 289  
Per mobile da L 120 a 170 cm

Art. **F704** - P. 289  
Per mobile da L 171 a 190 cm

Art. **F705** - P. 289  
Per mobile da L 191 a 220 cm

Art. **F706** - P. 289  
Per mobile da L 221 a 260 cm



## Kuki sp. 8 cm

Piani top sp. 8 cm (senza foro troppo pieno)  
Th. 8 cm tops (without overflow)  
Plan de toilette H 8 cm (sans trop-plein)

Vasca L 50 x P 31 x H 10 cm / interior W 50 x D 31 x H 10 cm / vasque int. L 50 x P 31 x H 10 cm

vasca singola  
one sink / 1 vasque

Art. **F267** - P. 289  
Per mobile da L 70 a 105 cm

Art. **F268** - P. 289  
Per mobile da L 106 a 140 cm

Art. **F269** - P. 289  
Per mobile da L 141 a 170 cm

Art. **F270** - P. 289  
Per mobile da L 171 a 190 cm

Art. **F271** - P. 289  
Per mobile da L 191 a 220 cm

Art. **F272** - P. 289  
Per mobile da L 221 a 260 cm

vasca doppia  
twin sink / double vasque

Art. **F273** - P. 289  
Per mobile da L 140 a 170 cm

Art. **F274** - P. 289  
Per mobile da L 171 a 190 cm

Art. **F275** - P. 289  
Per mobile da L 191 a 220 cm

Art. **F276** - P. 289  
Per mobile da L 221 a 260 cm

**ATTENZIONE!** I piani top sp. 8 cm vanno sempre impiegati in appoggio dal momento che l'altezza della vasca supera lo spessore del piano / **NOTE!** The tops 8 cm thick must always be used as countertops when the height of the basin exceeds the depth of the top / **ATTENTION!** Les plans de toilette ép. 8 cm doivent toujours être posés cal la hauteur de la vasque dépasse l'épaisseur du plan.



## Plaza sp. 1,2 cm

Piani top sp. 1,2 cm (senza foro troppo pieno)  
Th. 1,2 cm tops (without overflow)  
Plan de toilette H 1,2 cm (sans trop-plein)

Vasca L 70 x P 31 x H 10 cm / interior W 70 x D 31 x H 10 cm / vasque int. L 70 x P 31 x H 10 cm

vasca singola  
one sink / 1 vasque

Art. **F505** - P. 289  
Per mobile da L 85 a 105 cm

Art. **F506** - P. 289  
Per mobile da L 106 a 140 cm

Art. **F507** - P. 289  
Per mobile da L 141 a 170 cm

Art. **F508** - P. 289  
Per mobile da L 171 a 190 cm

Art. **F509** - P. 289  
Per mobile da L 191 a 220 cm

Art. **F510** - P. 289  
Per mobile da L 221 a 260 cm

vasca doppia  
twin sink / double vasque

Art. **F618** - P. 289  
Per mobile da L 170 a 190 cm

Art. **F619** - P. 289  
Per mobile da L 191 a 220 cm

Art. **F620** - P. 289  
Per mobile da L 221 a 260 cm



## Plaza sp. 8 cm

Piani top sp. 8 cm (senza foro troppo pieno)  
Th. 8 cm tops (without overflow)  
Plan de toilette H 8 cm (sans trop-plein)

Vasca L 70 x P 31 x H 10 cm / interior W 70 x D 31 x H 10 cm / vasque int. L 70 x P 31 x H 10 cm

vasca singola  
one sink / 1 vasque

Art. **F466** - P. 289  
Per mobile da L 85 a 105 cm

Art. **F467** - P. 289  
Per mobile da L 106 a 140 cm

Art. **F468** - P. 289  
Per mobile da L 141 a 170 cm

Art. **F469** - P. 289  
Per mobile da L 171 a 190 cm

Art. **F470** - P. 289  
Per mobile da L 191 a 220 cm

Art. **F471** - P. 289  
Per mobile da L 221 a 260 cm

vasca doppia  
twin sink / double vasque

Art. **F473** - P. 289  
Per mobile da L 170 a 190 cm

Art. **F474** - P. 289  
Per mobile da L 191 a 220 cm

Art. **F475** - P. 289  
Per mobile da L 221 a 260 cm

**ATTENZIONE!** I piani top sp. 8 cm vanno sempre impiegati in appoggio dal momento che l'altezza della vasca supera lo spessore del piano / **NOTE!** The tops 8 cm thick must always be used as countertops when the height of the basin exceeds the depth of the top / **ATTENTION!** Les plans de toilette ép. 8 cm doivent toujours être posés cal la hauteur de la vasque dépasse l'épaisseur du plan.



## Kuki sp. 12,2 cm

Piani top sp. 12,2 cm (senza foro troppo pieno)  
Th. 12,2 cm tops (without overflow)  
Plan de toilette H 12,2 cm (sans trop-plein)

Vasca L 50 x P 31 x H 10 cm / interior W 50 x D 31 x H 10 cm / vasque int. L 50 x P 31 x H 10 cm

vasca singola  
one sink / 1 vasque

Art. **F707** - P. 289  
Per mobile da L 70 a 105 cm

Art. **F708** - P. 289  
Per mobile da L 106 a 140 cm

Art. **F709** - P. 289  
Per mobile da L 141 a 170 cm

Art. **F710** - P. 289  
Per mobile da L 171 a 190 cm

Art. **F711** - P. 289  
Per mobile da L 191 a 220 cm

Art. **F712** - P. 289  
Per mobile da L 221 a 260 cm

vasca doppia  
twin sink / double vasque

Art. **F627** - P. 289  
Per mobile da L 140 a 170 cm

Art. **F628** - P. 289  
Per mobile da L 171 a 190 cm

Art. **F629** - P. 289  
Per mobile da L 191 a 220 cm

Art. **F630** - P. 289  
Per mobile da L 221 a 260 cm

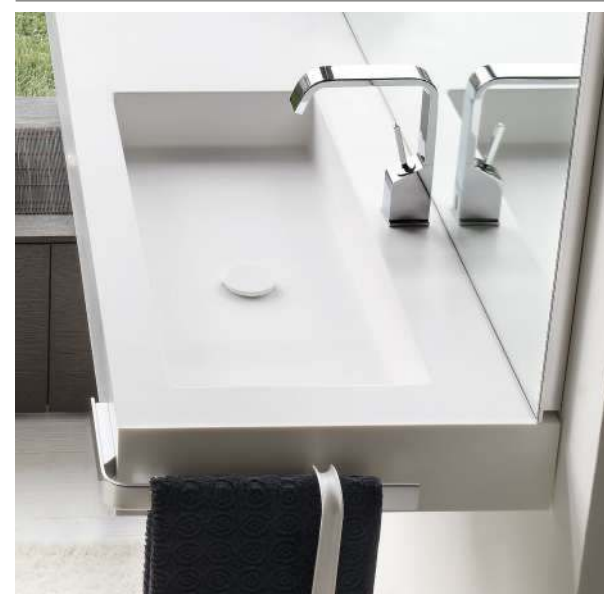

## Plaza sp. 12,2 cm

Piani top sp. 12,2 cm (senza foro troppo pieno)  
Th. 12,2 cm tops (without overflow)  
Plan de toilette H 12,2 cm (sans trop-plein)

Vasca L 70 x P 31 x H 10 cm / interior W 70 x D 31 x H 10 cm / vasque int. L 70 x P 31 x H 10 cm

vasca singola  
one sink / 1 vasque

Art. **F713** - P. 289  
Per mobile da L 85 a 105 cm

Art. **F714** - P. 289  
Per mobile da L 106 a 140 cm

Art. **F715** - P. 289  
Per mobile da L 141 a 170 cm

Art. **F716** - P. 289  
Per mobile da L 171 a 190 cm

Art. **F717** - P. 289  
Per mobile da L 191 a 220 cm

Art. **F718** - P. 289  
Per mobile da L 221 a 260 cm

vasca doppia  
twin sink / double vasque

Art. **F608** - P. 289  
Per mobile da L 170 a 190 cm

Art. **F609** - P. 289  
Per mobile da L 191 a 220 cm

Art. **F610** - P. 289  
Per mobile da L 221 a 260 cm



## Kuki e Plaza in marmo / marble / marbre

Piani top sp. 2 e 12,2 cm (senza foro troppo pieno)  
Th. 2 and 12,2 cm tops (without overflow)  
Plan de toilette H 2 et 12,2 cm (sans trop-plein)

### KUKI:

Vasca L 50 x P 31 x H 10 cm  
interior W 50 x D 31 x H 10 cm  
vasque int. L 50 x P 31 x H 10 cm

Per basi portalavabo min. L 60 x P 50 cm /  
for washbasin units min. W 60 x D 50 cm /  
meuble s/lavabo L 60 x P 50 cm

### PLAZA:

Vasca L 70 x P 31 x H 10 cm  
interior W 70 x D 31 x H 10 cm  
vasque int. 70 x P 31 x H 10 cm

Per basi portalavabo min. L 85 x P 50 cm /  
for washbasin units min. W 85 x D 50 cm /  
meuble s/lavabo L 85 x P 50 cm

Finiture / finishes / finitions:

#### marmo / marble / marbre CAT. A:



#### marmo / marble / marbre CAT. B:



#### marmo / marble / marbre CAT. C:



## Kuki sp. 2 cm in marmo / marble / marbre

### vasca singola

Art. **F567** - P. 292  
Per mobile da L 60 a 105 cm

Art. **F568** - P. 292  
Per mobile da L 106 a 140 cm

Art. **F569** - P. 292  
Per mobile da L 141 a 170 cm

Art. **F570** - P. 292  
Per mobile da L 171 a 190 cm

Art. **F571** - P. 292  
Per mobile da L 191 a 220 cm

Art. **F572** - P. 292  
Per mobile da L 221 a 260 cm

### vasca doppia

Art. **F307** - P. 292  
Per mobile da L 120 a 170 cm

Art. **F304** - P. 292  
Per mobile da L 171 a 190 cm

Art. **F305** - P. 292  
Per mobile da L 191 a 220 cm

Art. **F306** - P. 292  
Per mobile da L 221 a 260 cm



## Kuki sp. 12,2 cm in marmo / marble / marbre

### vasca singola

Art. **F107** - P. 292  
Per mobile da L 70 a 105 cm

Art. **F108** - P. 292  
Per mobile da L 106 a 140 cm

Art. **F109** - P. 292  
Per mobile da L 141 a 170 cm

Art. **F110** - P. 292  
Per mobile da L 171 a 190 cm

Art. **F111** - P. 292  
Per mobile da L 191 a 220 cm

Art. **F112** - P. 292  
Per mobile da L 221 a 260 cm

### vasca doppia

Art. **F427** - P. 292  
Per mobile da L 140 a 170 cm

Art. **F428** - P. 292  
Per mobile da L 171 a 190 cm

Art. **F429** - P. 292  
Per mobile da L 191 a 220 cm

Art. **F430** - P. 292  
Per mobile da L 221 a 260 cm



## Plaza sp. 2 cm in marmo / marble / marbre

### vasca singola

Art. **F205** - P. 292  
Per mobile da L 85 a 105 cm

Art. **F206** - P. 292  
Per mobile da L 106 a 140 cm

Art. **F207** - P. 292  
Per mobile da L 141 a 170 cm

Art. **F208** - P. 292  
Per mobile da L 171 a 190 cm

Art. **F209** - P. 292  
Per mobile da L 191 a 220 cm

Art. **F210** - P. 292  
Per mobile da L 221 a 260 cm

### vasca doppia

Art. **F318** - P. 292  
Per mobile da L 170 a 190 cm

Art. **F319** - P. 292  
Per mobile da L 191 a 220 cm

Art. **F320** - P. 292  
Per mobile da L 221 a 260 cm



## Plaza sp. 12,2 cm in marmo / marble / marbre

### vasca singola

Art. **F113** - P. 292  
Per mobile da L 85 a 105 cm

Art. **F114** - P. 292  
Per mobile da L 106 a 140 cm

Art. **F115** - P. 292  
Per mobile da L 141 a 170 cm

Art. **F116** - P. 292  
Per mobile da L 171 a 190 cm

Art. **F117** - P. 292  
Per mobile da L 191 a 220 cm

Art. **F118** - P. 289  
Per mobile da L 221 a 260 cm

### vasca doppia

Art. **F808** - P. 292  
Per mobile da L 170 a 190 cm

Art. **F809** - P. 292  
Per mobile da L 191 a 220 cm

Art. **F810** - P. 292  
Per mobile da L 221 a 260 cm



## Slot e Riga

Piani top sp. 1,2, 8 e 12,2 cm (senza foro troppo pieno, con scarico ispezionabile)  
Th. 1,2, 8 and 12,2 cm tops (without overflow. Drain can be inspected)  
Plan de toilette H 1,2, 8 et 12,2 cm (sans trop-plein, avec évacuation contrôlable)

### SLOT:

Vasca L 50 x P 31 x H 10 cm  
interior W 50 x D 31 x H 10 cm  
vasque int. L 50 x P 31 x H 10 cm

Per basi portalavabo min. L 60 x P 50 cm (per sp. 1,2 cm)  
L 70 x P 50 cm (per sp. 8 e 12,2 cm) /  
for washbasin units min. W 60 x D 50 cm (for 1,2 cm th.)  
W 70 x D 50 cm (for 8 and 12,2 cm th.) /  
meuble S/lavabo L 60 x P 37 cm (pour ep. 1,2 cm)  
L 70 x P 50 cm (pour 8 et 12,2 cm)

### RIGA:

Vasca L 70 x P 31 x H 10 cm  
interior W 70 x D 31 x H 10 cm  
vasque int. 70 x P 31 x H 10 cm

Per basi portalavabo min. L 85 x P 50 cm /  
for washbasin units min. W 85 x D 50 cm /  
meuble S/lavabo L 85 x P 50 cm

Finiture / finishes / finitions:

#### mineralguss:



bianco

#### tekno:



bianco

SLOT:

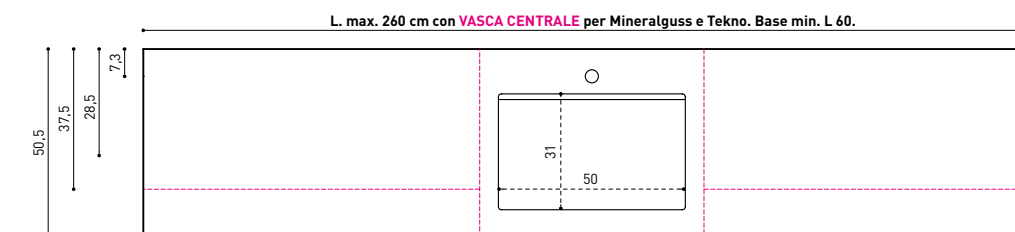

RIGA:

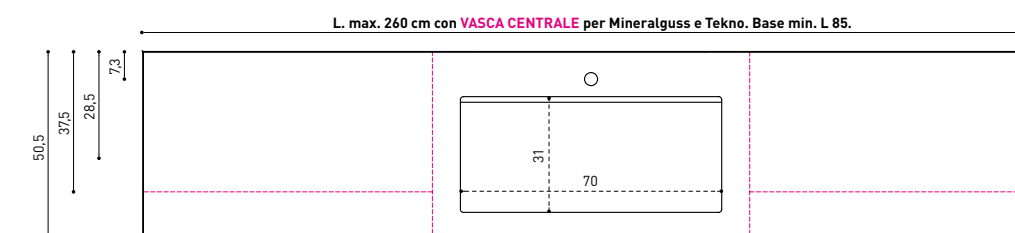



## Slot sp. 1,2 cm

Piani top sp. 1,2 cm (senza foro troppo pieno)  
Th. 1,2 cm tops (without overflow)  
Plan de toilette H 1,2 cm (sans trop-plein)

Vasca L 50 x P 31 x H 10 cm / interior W 50 x D 31 x H 10 cm / vasque int. L 50 x P 31 x H 10 cm

### vasca singola

Art. **A238** - P. 291  
Per mobile da L 60 a 105 cm

Art. **A239** - P. 291  
Per mobile da L 106 a 140 cm

Art. **A240** - P. 291  
Per mobile da L 141 a 170 cm

Art. **A241** - P. 291  
Per mobile da L 171 a 190 cm

Art. **A242** - P. 291  
Per mobile da L 191 a 220 cm

Art. **A243** - P. 291  
Per mobile da L 221 a 260 cm

### vasca doppia

Art. **A244** - P. 291  
Per mobile da L 120 a 170 cm

Art. **v245** - P. 291  
Per mobile da L 171 a 190 cm

Art. **A246** - P. 291  
Per mobile da L 191 a 220 cm

Art. **A247** - P. 291  
Per mobile da L 221 a 260 cm

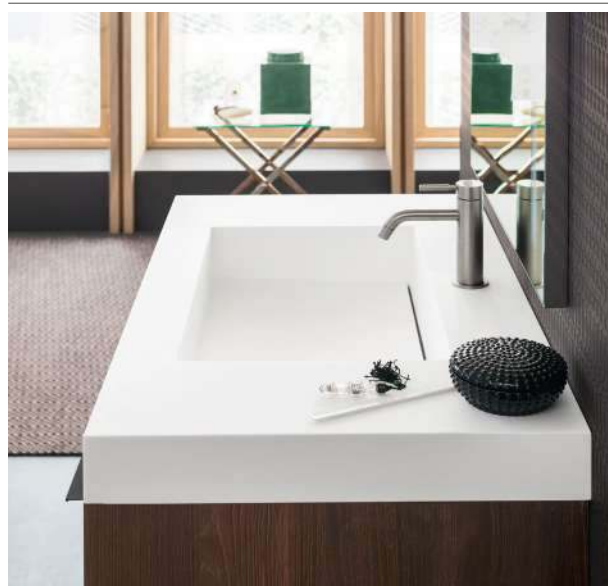

## Slot sp. 8 cm

Piani top sp. 8 cm (senza foro troppo pieno)  
Th. 8 cm tops (without overflow)  
Plan de toilette H 8 cm (sans trop-plein)

Vasca L 50 x P 31 x H 10 cm / interior W 50 x D 31 x H 10 cm / vasque int. L 50 x P 31 x H 10 cm

### vasca singola

Art. **F522** - P. 291  
Per mobile da L 70 a 105 cm

Art. **F523** - P. 291  
Per mobile da L 106 a 140 cm

Art. **F524** - P. 291  
Per mobile da L 141 a 170 cm

Art. **F525** - P. 291  
Per mobile da L 171 a 190 cm

Art. **F526** - P. 291  
Per mobile da L 191 a 220 cm

Art. **F527** - P. 291  
Per mobile da L 221 a 260 cm

### vasca doppia

Art. **F528** - P. 291  
Per mobile da L 140 a 170 cm

Art. **F529** - P. 291  
Per mobile da L 171 a 190 cm

Art. **F530** - P. 291  
Per mobile da L 191 a 220 cm

Art. **F531** - P. 291  
Per mobile da L 221 a 260 cm

**ATTENZIONE!** I piani top sp. 8 cm vanno sempre impiegati in appoggio dal momento che l'altezza della vasca supera lo spessore del piano / **NOTE!** The tops 8 cm thick must always be used as countertops when the height of the basin exceeds the depth of the top / **ATTENTION!** Les plans de toilette ép. 8 cm doivent toujours être posés cal la hauteur de la vasque dépasse l'épaisseur du plan.



## Slot sp. 12,2 cm

Piani top sp. 12,2 cm (senza foro troppo pieno)  
Th. 12,2 cm tops (without overflow)  
Plan de toilette H 12,2 cm (sans trop-plein)

Vasca L 50 x P 31 x H 10 cm / interior W 50 x D 31 x H 10 cm / vasque int. L 50 x P 31 x H 10 cm

### vasca singola

Art. **A248** - P. 291  
Per mobile da L 70 a 105 cm

Art. **A249** - P. 291  
Per mobile da L 106 a 140 cm

Art. **A250** - P. 291  
Per mobile da L 141 a 170 cm

Art. **A251** - P. 291  
Per mobile da L 171 a 190 cm

Art. **A252** - P. 291  
Per mobile da L 191 a 220 cm

Art. **A253** - P. 291  
Per mobile da L 221 a 260 cm

### vasca doppia

Art. **A254** - P. 291  
Per mobile da L 140 a 170 cm

Art. **A255** - P. 291  
Per mobile da L 171 a 190 cm

Art. **A256** - P. 291  
Per mobile da L 191 a 220 cm

Art. **A257** - P. 291  
Per mobile da L 221 a 260 cm



## Riga sp. 1,2 cm

Piani top sp. 1,2 cm (senza foro troppo pieno)  
Th. 1,2 cm tops (without overflow)  
Plan de toilette H 1,2 cm (sans trop-plein)

Vasca L 70 x P 31 x H 10 cm / interior W 70 x D 31 x H 10 cm / vasque int. L 70 x P 31 x H 10 cm

### vasca singola

Art. **A258** - P. 291  
Per mobile da L 85 a 105 cm

Art. **A259** - P. 291  
Per mobile da L 106 a 140 cm

Art. **A260** - P. 291  
Per mobile da L 141 a 170 cm

Art. **A261** - P. 291  
Per mobile da L 171 a 190 cm

Art. **A262** - P. 291  
Per mobile da L 191 a 220 cm

Art. **A263** - P. 291  
Per mobile da L 221 a 260 cm

### vasca doppia

Art. **A265** - P. 291  
Per mobile da L 170 a 190 cm

Art. **A266** - P. 291  
Per mobile da L 191 a 220 cm

Art. **A267** - P. 291  
Per mobile da L 221 a 260 cm

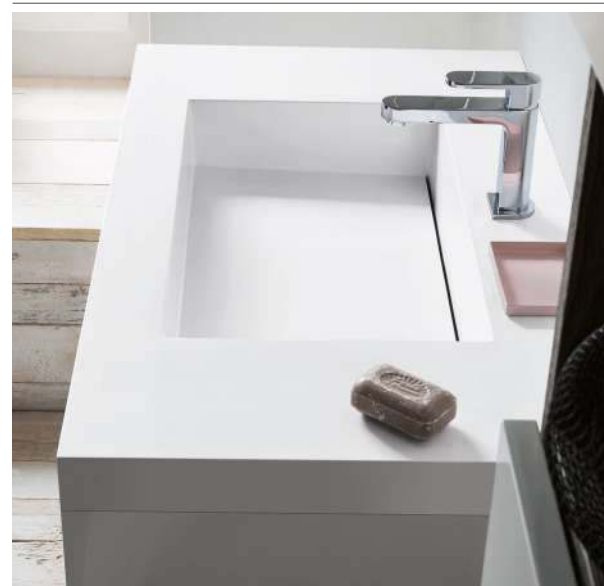

## Riga sp. 8 cm

Piani top sp. 8 cm (senza foro troppo pieno)  
Th. 8 cm tops (without overflow)  
Plan de toilette H 8 cm (sans trop-plein)

Vasca L 70 x P 31 x H 10 cm / interior W 70 x D 31 x H 10 cm / vasque int. L 70 x P 31 x H 10 cm

### vasca singola

Art. **F532** - P. 291  
Per mobile da L 85 a 105 cm

Art. **F533** - P. 291  
Per mobile da L 106 a 140 cm

Art. **F534** - P. 291  
Per mobile da L 141 a 170 cm

Art. **F535** - P. 291  
Per mobile da L 171 a 190 cm

Art. **F536** - P. 291  
Per mobile da L 191 a 220 cm

Art. **F537** - P. 291  
Per mobile da L 221 a 260 cm

### vasca doppia

Art. **F539** - P. 291  
Per mobile da L 170 a 190 cm

Art. **F540** - P. 291  
Per mobile da L 191 a 220 cm

Art. **F541** - P. 291  
Per mobile da L 221 a 260 cm

**ATTENZIONE!** I piani top sp. 8 cm vanno sempre impiegati in appoggio dal momento che l'altezza della vasca supera lo spessore del piano / **NOTE!** The tops 8 cm thick must always be used as countertops when the height of the basin exceeds the depth of the top / **ATTENTION!** Les plans de toilette ép. 8 cm doivent toujours être posés cal la hauteur de la vasque dépasse l'épaisseur du plan.



## Riga sp. 12,2 cm

Piani top sp. 12,2 cm (senza foro troppo pieno)  
Th. 12,2 cm tops (without overflow)  
Plan de toilette H 12,2 cm (sans trop-plein)

Vasca L 70 x P 31 x H 10 cm / interior W 70 x D 31 x H 10 cm / vasque int. L 70 x P 31 x H 10 cm

### vasca singola

Art. **A268** - P. 291  
Per mobile da L 85 a 105 cm

Art. **A269** - P. 291  
Per mobile da L 106 a 140 cm

Art. **A270** - P. 291  
Per mobile da L 141 a 170 cm

Art. **A271** - P. 291  
Per mobile da L 171 a 190 cm

Art. **A272** - P. 291  
Per mobile da L 191 a 220 cm

Art. **A273** - P. 291  
Per mobile da L 221 a 260 cm

### vasca doppia

Art. **A275** - P. 291  
Per mobile da L 170 a 190 cm

Art. **A276** - P. 291  
Per mobile da L 191 a 220 cm

Art. **A277** - P. 291  
Per mobile da L 221 a 260 cm



## Serra

Piani top sp. 1,2, 8 e 12,2 cm (senza foro troppo pieno)  
Th. 1,2, 8 and 12,2 cm tops (without overflow)  
Plan de toilette H 1,2, 8 et 12,2 cm (sans trop-plein)

Vasca L 58 x P 28 x H 11 cm / interior W 58 x D 28 x H 11 cm /  
vasque int. L 58 x P 28 x H 11 cm

Per basi portalavabo min. L 70 x P 50 cm (per sp. 1,2 cm)  
L 85 x P 50 cm (per sp. 8 e 12,2 cm) /  
for washbasin units min. W 70 x D 50 cm (for 1,2 cm th.)  
W 85 x D 50 cm (for 8 and 12,2 cm th.) /  
Meuble S/lavabo L 70 x P 37 cm (pour ep. 1,2 cm)  
L 85 x P 50 cm (pour 8 et 12,2 cm)

Finiture / finishes / finitions:

gres:

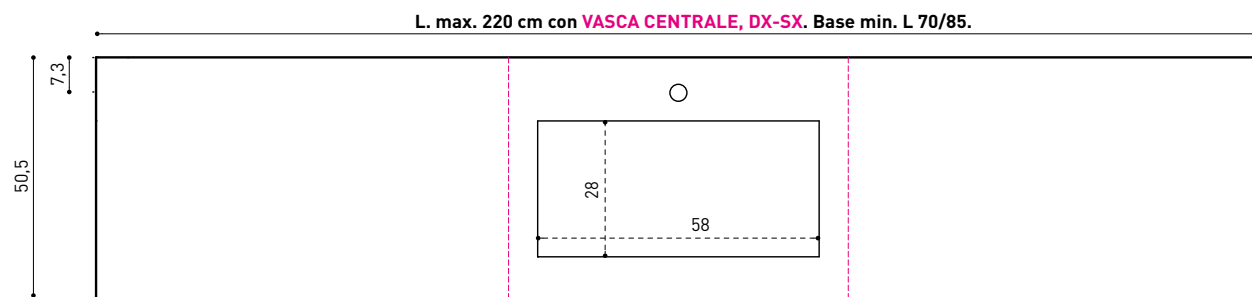
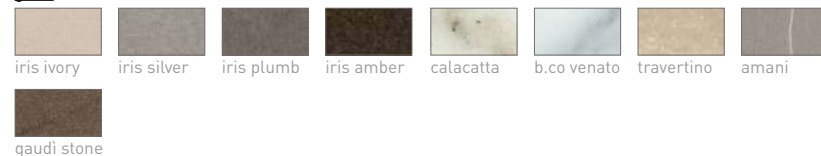

## Serra sp. 1,2 cm

Piani top sp. 1,2 cm (senza foro troppo pieno)  
Th. 1,2 cm tops (without overflow)  
Plan de toilette H 1,2 cm (sans trop-plein)

Vasca L 58 x P 28 x H 11 cm / interior W 58 x D 28 x H 11 cm / vasque int. L 58 x P 28 x H 11 cm

vasca singola  
one sink / 1 vasque

Art. **F437** - P. 291  
Per mobile da L 70 a 105 cm

Art. **F438** - P. 291  
Per mobile da L 106 a 140 cm

Art. **F439** - P. 291  
Per mobile da L 141 a 170 cm

Art. **F440** - P. 291  
Per mobile da L 171 a 190 cm

Art. **F441** - P. 291  
Per mobile da L 191 a 220 cm

vasca doppia  
twin sink / double vasque

Art. **F442** - P. 291  
Per mobile da L 140 a 190 cm

Art. **F443** - P. 291  
Per mobile da L 191 a 220 cm



## Serra sp. 8 cm

Piani top sp. 8 cm (senza foro troppo pieno)  
Th. 8 cm tops (without overflow)  
Plan de toilette H 8 cm (sans trop-plein)

Vasca L 58 x P 28 x H 11 cm / interior W 58 x D 28 x H 11 cm / vasque int. L 58 x P 28 x H 11 cm

vasca singola  
one sink / 1 vasque

Art. **F444** - P. 291  
Per mobile da L 85 a 105 cm

Art. **F445** - P. 291  
Per mobile da L 106 a 140 cm

Art. **F446** - P. 291  
Per mobile da L 141 a 170 cm

Art. **F447** - P. 291  
Per mobile da L 171 a 190 cm

Art. **F448** - P. 291  
Per mobile da L 191 a 220 cm

vasca doppia  
twin sink / double vasque

Art. **F449** - P. 291  
Per mobile da L 170 a 190 cm

Art. **F450** - P. 291  
Per mobile da L 191 a 220 cm

**ATTENZIONE!** I piani top sp. 8 cm vanno sempre impiegati in appoggio dal momento che l'altezza della vasca supera lo spessore del piano / **NOTE!** The tops 8 cm thick must always be used as countertops when the height of the basin exceeds the depth of the top / **ATTENTION!** Les plans de toilette ép. 8 cm doivent toujours être posés car la hauteur de la vasque dépasse l'épaisseur du plan.

## Serra sp. 12,2 cm

Piani top sp. 12,2 cm (senza foro troppo pieno)  
Th. 12,2 cm tops (without overflow)  
Plan de toilette H 12,2 cm (sans trop-plein)

Vasca L 58 x P 28 x H 11 cm / interior W 58 x D 28 x H 11 cm / vasque int. L 58 x P 28 x H 11 cm

vasca singola  
one sink / 1 vasque

Art. **F451** - P. 291  
Per mobile da L 85 a 105 cm

Art. **F452** - P. 291  
Per mobile da L 106 a 140 cm

Art. **F453** - P. 291  
Per mobile da L 141 a 170 cm

Art. **F454** - P. 291  
Per mobile da L 171 a 190 cm

Art. **F455** - P. 291  
Per mobile da L 191 a 220 cm

vasca doppia  
twin sink / double vasque

Art. **F456** - P. 291  
Per mobile da L 170 a 190 cm

Art. **F457** - P. 291  
Per mobile da L 191 a 220 cm



## Note e Diesis

Finiture / finishes / finitions:

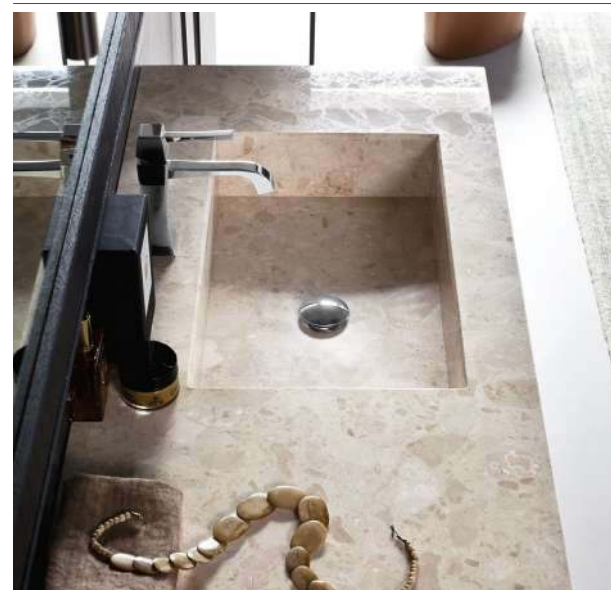
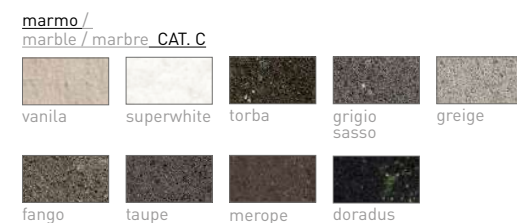

### Note **sp. 7 cm**

Piano top sp. 7 cm (senza foro troppo pieno)  
Th. 7 cm tops (without overflow)  
plan de toilette H 7 cm (sans trop-plein)

Vasca L 50 x P 31 x H 10 cm / interior W 50 x D 31 x H 10 cm / vasque int. L 50 x P 31 x H 10 cm  
Per basi portlavabo min. L 60 x P 50 cm / for washbasin units min. W 60 x D 50 cm / meuble S/lavabo L 60 x P 50 cm

vasca singola

Art. **F164** - P. 293  
Per mobile da L 60 a 105 cm

Art. **F165** - P. 293  
Per mobile da L 106 a 140 cm

Art. **F166** - P. 293  
Per mobile da L 141 a 170 cm

Art. **F167** - P. 293  
Per mobile da L 171 a 190 cm

Art. **F168** - P. 293  
Per mobile da L 191 a 220 cm

Art. **F169** - P. 293  
Per mobile da L 221 a 260 cm

vasca doppia

Art. **F170** - P. 293  
Per mobile da L 140 a 170 cm

Art. **F171** - P. 293  
Per mobile da L 171 a 190 cm

Art. **F172** - P. 293  
Per mobile da L 191 a 220 cm

Art. **F173** - P. 293  
Per mobile da L 221 a 260 cm



### Diesis **sp. 7 cm**

Piano top sp. 7 cm (senza foro troppo pieno)  
Th. 7 cm tops (without overflow)  
plan de toilette H 7 cm (sans trop-plein)

Vasca L 70 x P 31 x H 10 cm / interior W 70 x D 31 x H 10 cm / vasque int. L 70 x P 31 x H 10 cm  
Per basi portlavabo min. L 85 x P 50 cm / for washbasin units min. W 85 x D 50 cm / meuble S/lavabo L 85 x P 50 cm

vasca singola

Art. **F174** - P. 293  
Per mobile da L 85 a 105 cm

Art. **F175** - P. 293  
Per mobile da L 106 a 140 cm

Art. **F176** - P. 293  
Per mobile da L 141 a 170 cm

Art. **F177** - P. 293  
Per mobile da L 171 a 190 cm

Art. **F178** - P. 293  
Per mobile da L 191 a 220 cm

Art. **F179** - P. 293  
Per mobile da L 221 a 260 cm

vasca doppia

Art. **F181** - P. 293  
Per mobile da L 170 a 190 cm

Art. **F182** - P. 293  
Per mobile da L 191 a 220 cm

Art. **F183** - P. 293  
Per mobile da L 221 a 260 cm





## Bob piccolo - Bob grande

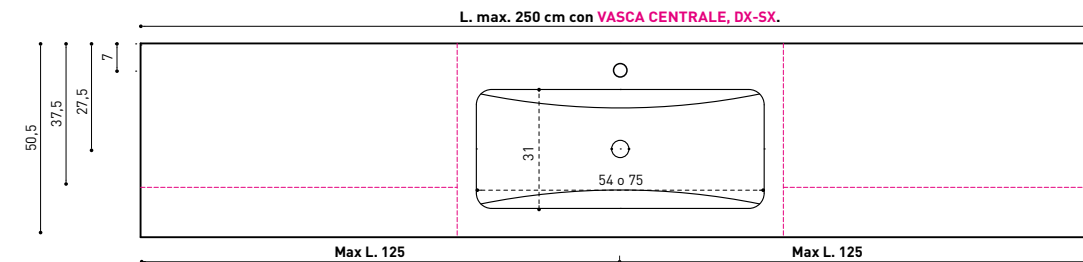

DuPont™  
**CORIAN®**  
SOLID SURFACES

### Bob piccolo

Piani top sp. 1,2 cm (senza foro troppo pieno)  
Th. 1,2 cm tops (without overflow)  
Plan de toilette H 1,2 cm (sans trop-plein)

Vasca L 54 x P 31 x H 12 cm / interior W 54 x D 31 x H 12 cm / vasque int. L 54 x P 31 x H 12 cm  
Per basi portalavabo min. L 70 x P 50 cm / for washbasin units min. W 70 x D 50 cm / meuble S/lavabo L 70 x P 50 cm

Finiture / finishes / finitions:  
corian:

vasca singola  
one sink / 1 vasque

Art. **F828** - P. 295  
Per mobile da L 70 a 105 cm

Art. **F829** - P. 295  
Per mobile da L 106 a 140 cm

Art. **F830** - P. 295  
Per mobile da L 141 a 175 cm

Art. **F831** - P. 295  
Per mobile da L 176 a 190 cm

Art. **F832** - P. 295  
Per mobile da L 191 a 220 cm

Art. **F833** - P. 295  
Per mobile da L 221 a 250 cm

vasca doppia  
twin sink / double vasque

Art. **F834** - P. 295  
Per mobile da L 140 a 175 cm

Art. **F835** - P. 295  
Per mobile da L 176 a 190 cm

Art. **F836** - P. 295  
Per mobile da L 191 a 220 cm

Art. **F837** - P. 295  
Per mobile da L 221 a 250 cm

DuPont™  
**CORIAN®**  
SOLID SURFACES

### Bob grande

Piani top sp. 1,2 cm (senza foro troppo pieno)  
Th. 1,2 cm tops (without overflow)  
Plan de toilette H 1,2 cm (sans trop-plein)

Vasca L 75 x P 31 x H 12 cm / interior W 75 x D 31 x H 12 cm / vasque int. L 75 x P 31 x H 12 cm  
Per basi portalavabo min. L 85 x P 50 cm / for washbasin units min. W 85 x D 50 cm / meuble S/lavabo L 85 x P 50 cm

Finiture / finishes / finitions:  
corian:

vasca singola  
one sink / 1 vasque

Art. **F838** - P. 295  
Per mobile da L 85 a 105 cm

Art. **F839** - P. 295  
Per mobile da L 106 a 140 cm

Art. **F840** - P. 295  
Per mobile da L 141 a 175 cm

Art. **F841** - P. 295  
Per mobile da L 176 a 190 cm

Art. **F842** - P. 295  
Per mobile da L 191 a 220 cm

Art. **F843** - P. 295  
Per mobile da L 221 a 250 cm



## Fly 50-60-70

Piani top sp. 1 cm (senza foro troppo pieno)  
Th. 1 cm tops (without overflow)  
Plan de toilette H 1 cm (sans trop-plein)

Finiture / finishes / finitions:

corian:



DuPont™  
**CORIAN®**  
SOLID SURFACES

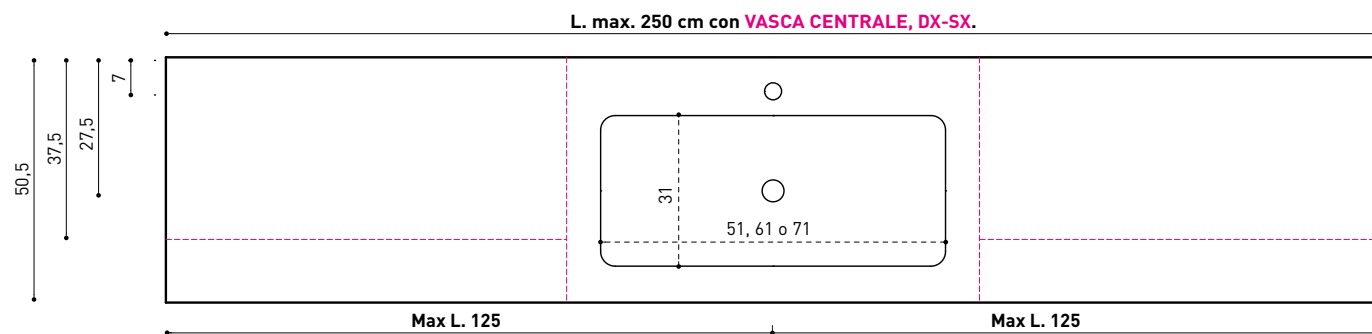

## Fly 50

Piani top sp. 1 cm (senza foro troppo pieno)  
Th. 1 cm tops (without overflow)  
Plan de toilette H 1 cm (sans trop-plein)

Vasca L 51 x P 31 x H 9 cm / interior W 51 x D 31 x H 9 cm / vasque int. L 51 x P 31 x H 9 cm  
Per basi port lavabo min. L 60 x P 50 cm / for washbasin units min. W 60 x D 50 cm / meuble S/lavabo L 60 x P 50 cm

vasca singola

Art. **F844** - P. 295  
Per mobile da L 70 a 105 cm

Art. **F845** - P. 295  
Per mobile da L 106 a 140 cm

Art. **F846** - P. 295  
Per mobile da L 141 a 175 cm

Art. **F847** - P. 295  
Per mobile da L 176 a 190 cm

Art. **F848** - P. 295  
Per mobile da L 191 a 220 cm

Art. **F849** - P. 295  
Per mobile da L 221 a 250 cm

vasca doppia

Art. **F850** - P. 295  
Per mobile da L 140 a 175 cm

Art. **F851** - P. 295  
Per mobile da L 176 a 190 cm

Art. **F852** - P. 295  
Per mobile da L 191 a 220 cm

Art. **F853** - P. 295  
Per mobile da L 221 a 250 cm

## Fly 60

Piani top sp. 1 cm (senza foro troppo pieno)  
Th. 1 cm tops (without overflow)  
Plan de toilette H 1 cm (sans trop-plein)

Vasca L 61 x P 31 x H 9 cm / interior W 61 x D 31 x H 9 cm / vasque int. L 61 x P 31 x H 9 cm  
Per basi port lavabo min. L 70 x P 50 cm / for washbasin units min. W 70 x D 50 cm / meuble S/lavabo L 70 x P 50 cm

vasca singola

Art. **F854** - P. 295  
Per mobile da L 70 a 105 cm

Art. **F855** - P. 295  
Per mobile da L 106 a 140 cm

Art. **F856** - P. 295  
Per mobile da L 141 a 175 cm

Art. **F857** - P. 295  
Per mobile da L 176 a 190 cm

Art. **F858** - P. 295  
Per mobile da L 191 a 220 cm

Art. **F859** - P. 295  
Per mobile da L 221 a 250 cm

vasca doppia

Art. **F860** - P. 295  
Per mobile da L 140 a 175 cm

Art. **F861** - P. 295  
Per mobile da L 176 a 190 cm

Art. **F862** - P. 295  
Per mobile da L 191 a 220 cm

Art. **F863** - P. 295  
Per mobile da L 221 a 250 cm

## Fly 70

Piani top sp. 1 cm (senza foro troppo pieno)  
Th. 1 cm tops (without overflow)  
Plan de toilette H 1 cm (sans trop-plein)

Vasca L 71 x P 31 x H 9 cm / interior W 71 x D 31 x H 9 cm / vasque int. L 71 x P 31 x H 9 cm  
Per basi port lavabo min. L 85 x P 50 cm / for washbasin units min. W 85 x D 50 cm / meuble S/lavabo L 85 x P 50 cm

vasca singola

Art. **F864** - P. 295  
Per mobile da L 85 a 105 cm

Art. **F865** - P. 295  
Per mobile da L 106 a 140 cm

Art. **F866** - P. 295  
Per mobile da L 141 a 175 cm

Art. **F867** - P. 295  
Per mobile da L 176 a 190 cm

Art. **F868** - P. 295  
Per mobile da L 191 a 220 cm

Art. **F869** - P. 295  
Per mobile da L 221 a 250 cm





## Rettangolare 64

Piani top sp. 1,2 cm (senza foro troppo pieno)  
Th. 1,2 cm tops (without overflow)  
Plan de toilette H 1,2 cm (sans trop-plein)

Corian / corian / corian  
Vasca L 64 x P 32 x H 12 cm /  
interior W 64 x D 32 x H 12 cm /  
vasque int. L 64 x P 32 x H 12 cm

Per basi portalavabo min. L 70 x P 50 cm /  
for washbasin units min. W 70 x D 50 cm /  
meuble S/lavabo L 70 x P 50 cm

vasca singola  
one sink / 1 vasque

vasca doppia  
twin sink / double vasque

Art. **F411** - P. 295  
Per mobile da L 70 a 105 cm

Art. **F412** - P. 295  
Per mobile da L 106 a 140 cm

Art. **F413** - P. 295  
Per mobile da L 141 a 175 cm

Art. **F414** - P. 295  
Per mobile da L 176 a 190 cm

Art. **F415** - P. 295  
Per mobile da L 191 a 220 cm

Art. **F416** - P. 295  
Per mobile da L 221 a 250 cm

Art. **F517** - P. 295  
Per mobile da L 140 a 175 cm

Art. **F518** - P. 295  
Per mobile da L 176 a 190 cm

Art. **F519** - P. 295  
Per mobile da L 191 a 220 cm

Art. **F520** - P. 295  
Per mobile da L 221 a 250 cm

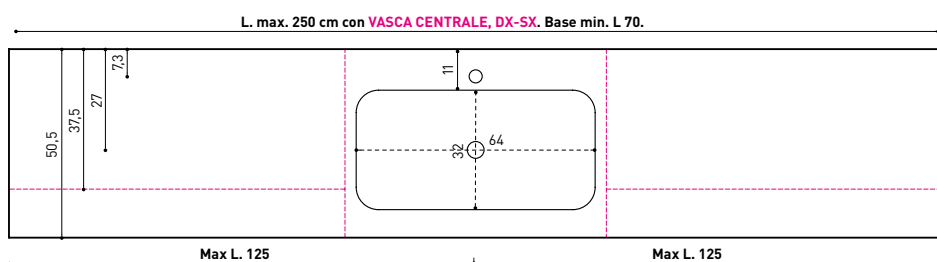

## Ovale 65

Piani top sp. 1,2 cm (senza foro troppo pieno)  
Th. 1,2 cm tops (without overflow)  
Plan de toilette H 1,2 cm (sans trop-plein)

Corian / corian / corian  
Vasca L 65 x P 32 x H 12 cm /  
interior W 65 x D 32 x H 12 cm /  
vasque int. L 65 x P 32 x H 12 cm

Per basi portalavabo min. L 70 x P 50 cm /  
for washbasin units min. W 70 x D 50 cm /  
meuble S/lavabo L 70 x P 50 cm  
Per basi portalavabo Fusion min. L 85 x P 50 cm /  
for Fusion washbasin units min. W 85 x D 50 cm /  
meuble S/lavabo Fusion L 85 x P 50 cm

vasca singola  
one sink / 1 vasque

vasca doppia  
twin sink / double vasque

Art. **F401** - P. 295  
Per mobile da L 70 a 105 cm

Art. **F402** - P. 295  
Per mobile da L 106 a 140 cm

Art. **F403** - P. 295  
Per mobile da L 141 a 175 cm

Art. **F404** - P. 295  
Per mobile da L 176 a 190 cm

Art. **F405** - P. 295  
Per mobile da L 191 a 220 cm

Art. **F406** - P. 295  
Per mobile da L 221 a 250 cm

Art. **F513** - P. 295  
Per mobile da L 140 a 175 cm

Art. **F514** - P. 295  
Per mobile da L 176 a 190 cm

Art. **F515** - P. 295  
Per mobile da L 191 a 220 cm

Art. **F516** - P. 295  
Per mobile da L 221 a 250 cm

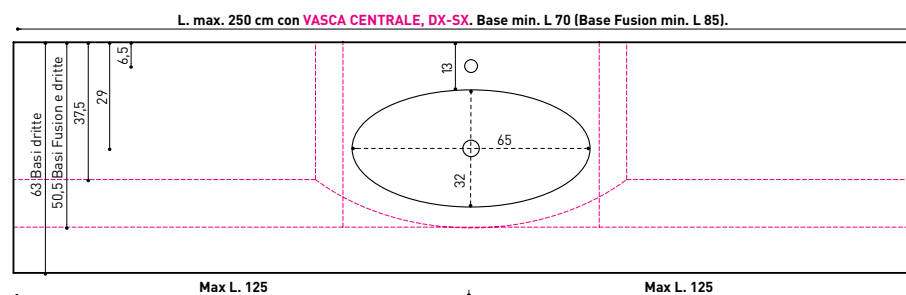

## Occhio grande

Piani top sp. 1,2 cm (senza foro troppo pieno)  
Th. 1,2 cm tops (without overflow)  
Plan de toilette H 1,2 cm (sans trop-plein)

Corian / corian / corian  
Vasca L 84 x P 32 x H 12 cm /  
interior W 84 x D 32 x H 12 cm /  
vasque int. L 84 x P 32 x H 12 cm

Per basi portalavabo min. L 95 x P 50 cm /  
for washbasin units min. W 95 x D 50 cm /  
meuble S/lavabo L 95 x P 50 cm

vasca singola  
one sink / 1 vasque

Art. **F421** - P. 295  
Per mobile da L 95 a 105 cm

Art. **F422** - P. 295  
Per mobile da L 106 a 140 cm

Art. **F423** - P. 295  
Per mobile da L 141 a 175 cm

Art. **F424** - P. 295  
Per mobile da L 176 a 190 cm

Art. **F425** - P. 295  
Per mobile da L 191 a 220 cm

Art. **F426** - P. 295  
Per mobile da L 221 a 250 cm

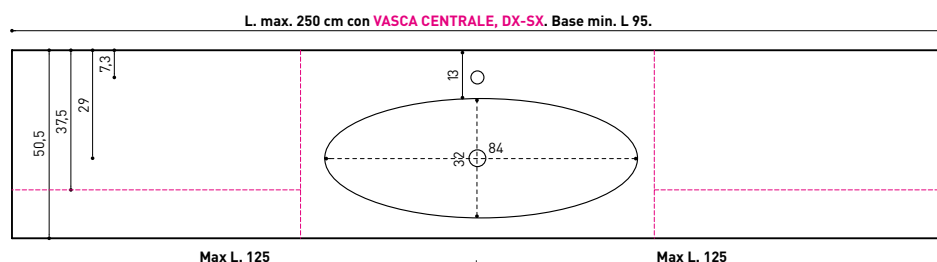

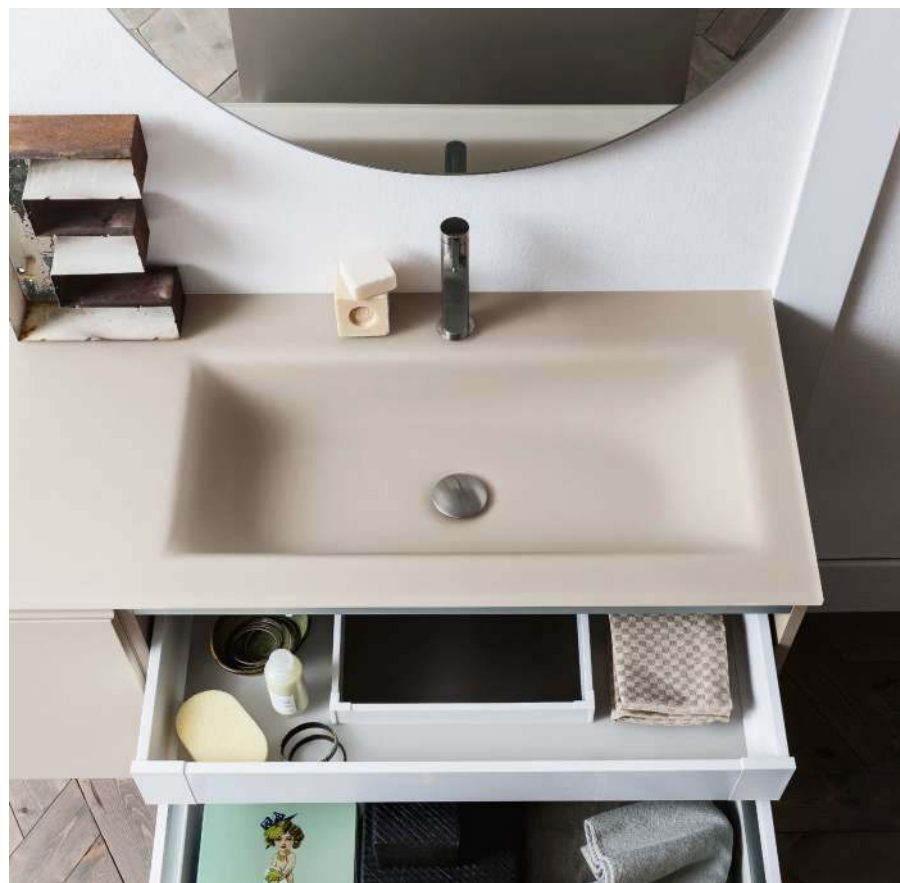

## Dilva

Piani top sp. 1 cm (senza foro troppo pieno)  
Th. 1 or 1,5 cm tops (without overflow)  
Plan de toilette H 1 cm (sans trop-plein)

Cristallo / glass / verre  
Vasca L 72 x P 35 x H 12 cm /  
interior W 72 x D 35 x H 12 cm /  
vasque int. L 72 x P 35 x H 12 cm

Per basi portalavabo min. L 85 x P 50 cm /  
for washbasin units min. W 85 x D 50 cm /  
meuble S/lavabo L 85 x P 50 cm

Sp. /Th. / Ép. 1 cm

Art. **F311** - P. 297  
Per mobile da L 85 a 105 cm

Art. **F312** - P. 297  
Per mobile da L 106 a 140 cm

Art. **F313** - P. 297  
Per mobile da L 141 a 175 cm

Art. **F314** - P. 297  
Per mobile da L 176 a 190 cm

Art. **F315** - P. 297  
Per mobile da L 191 a 220 cm

Art. **F316** - P. 297  
Per mobile da L 221 a 250 cm

## Dilva

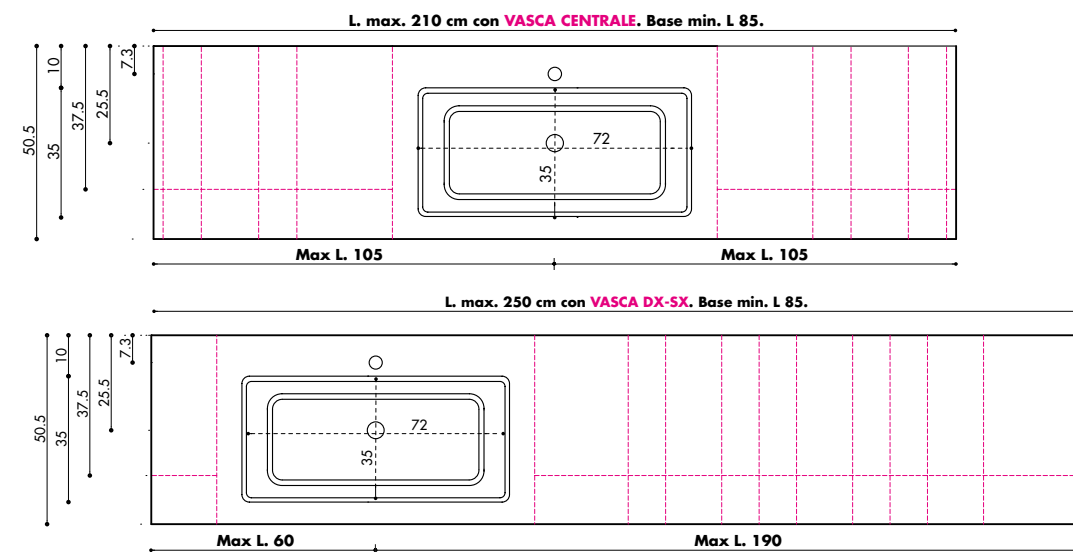

## Afro

Piani top sp. 1 cm (senza foro troppo pieno)  
Th. 1 or 1,5 cm tops (without overflow)  
Plan de toilette H 1 ou 1,5 cm (sans trop-plein)

Cristallo / glass / verre  
Vasca L 73,5 x P 37,5 x H 14 cm /  
interior W 73,5 x D 37,5 x H 14 cm /  
vasque int. L 73,5 x P 37,5 x H 14 cm

Per basi portalavabo min. L 85 x P 50 cm /  
for washbasin units min. W 85 x D 50 cm /  
meuble S/lavabo L 85 x P 50 cm

Sp. /Th. / Ép. 1 cm

Art. **F356** - P. 297  
Per mobile da L 85 a 105 cm

Art. **F357** - P. 297  
Per mobile da L 106 a 140 cm

Art. **F358** - P. 297  
Per mobile da L 141 a 175 cm

Art. **F359** - P. 297  
Per mobile da L 176 a 190 cm

Art. **F360** - P. 297  
Per mobile da L 191 a 220 cm

Art. **F371** - P. 297  
Per mobile da L 221 a 250 cm

## Afro

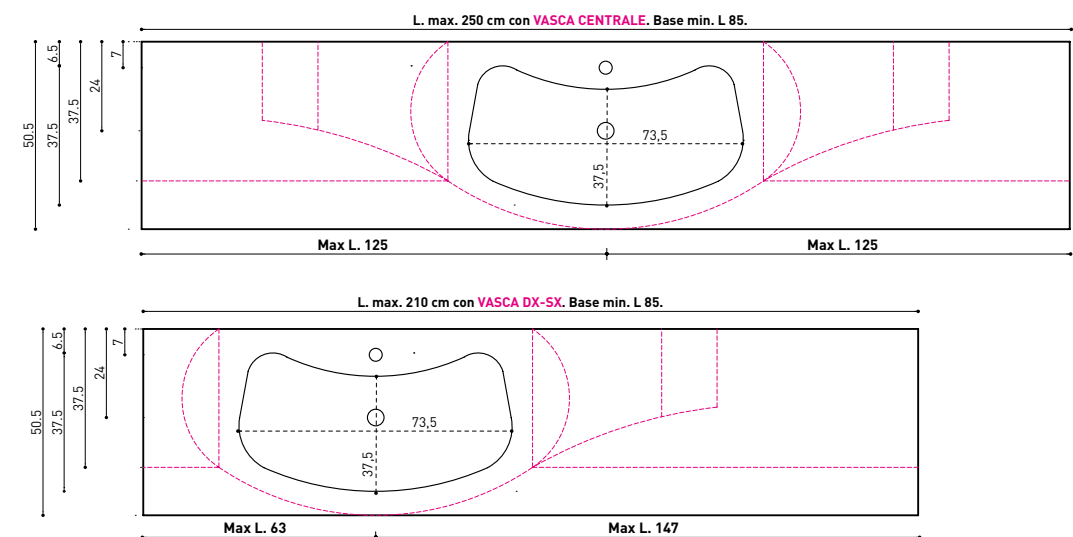

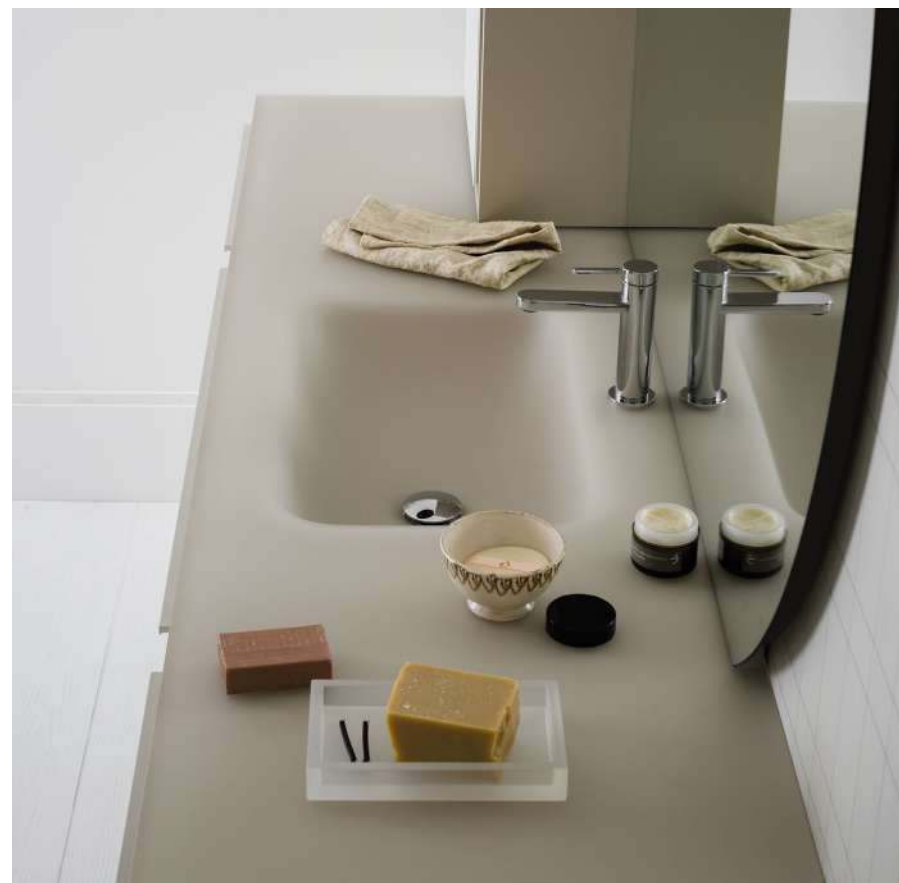

## Rettangolare piccolo

Piani top sp. 1 cm (senza foro troppo pieno)  
Th. 1 cm tops (without overflow)  
Plan de toilette H 1 cm (sans trop-plein)

Cristallo / glass / verre  
Vasca L 51 x P 31 x H 13 cm /  
interior W 51 x D 31 x H 13 cm /  
vasque int. L 51 x P 31 x H 13 cm

Per basi portlavabo min. L 70 x P 50 cm /  
for washbasin units min. W 70 x D 50 cm /  
meuble S/lavabo L 70 x P 50 cm

Sp. /Th. / Ép. 1 cm

vasca singola  
one sink / 1 vasque

Art. **F493** - P. 297  
Per mobile da L 70 a 105 cm

Art. **F494** - P. 297  
Per mobile da L 106 a 140 cm

Art. **F495** - P. 297  
Per mobile da L 141 a 175 cm

Art. **F496** - P. 297  
Per mobile da L 176 a 190 cm

Art. **F497** - P. 297  
Per mobile da L 191 a 220 cm

Art. **F498** - P. 297  
Per mobile da L 221 a 250 cm

vasca doppia  
twin sink / double vasque

Art. **F278** - P. 297  
Per mobile da L 140 a 175 cm

Art. **F279** - P. 297  
Per mobile da L 176 a 190 cm

Art. **F280** - P. 297  
Per mobile da L 191 a 220 cm

Art. **F281** - P. 297  
Per mobile da L 221 a 250 cm

## Rettangolare piccolo

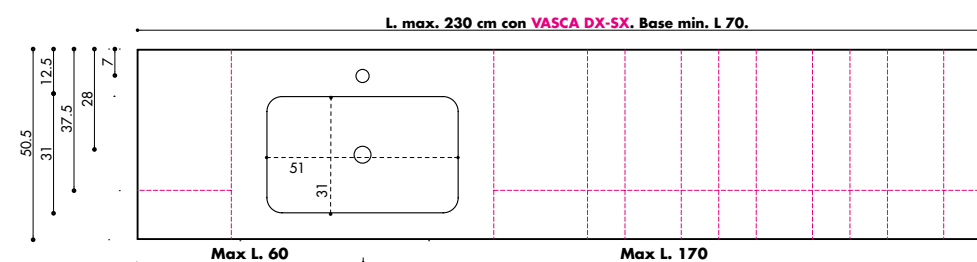
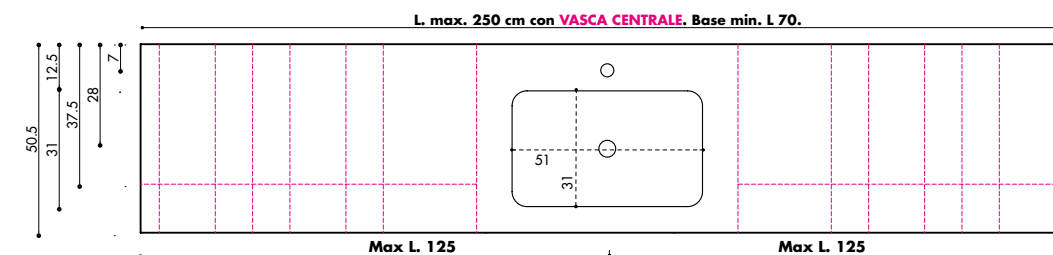

## Ovale 57

Piani top sp. 1 cm (senza foro troppo pieno)  
Th. 1 cm tops (without overflow)  
Plan de toilette H 1 cm (sans trop-plein)

Cristallo / glass / verre  
Vasca L 57 x P 31 x H 13 cm /  
interior W 57 x D 31 x H 13 cm /  
vasque int. L 57 x P 31 x H 13 cm

Per basi portlavabo min. L 70 x P 50 cm /  
for washbasin units min. W 70 x D 50 cm /  
meuble S/lavabo L 70 x P 50 cm

Sp. /Th. / Ép. 1 cm

Art. **F431** - P. 297  
Per mobile da L 70 a 105 cm

Art. **F432** - P. 297  
Per mobile da L 106 a 140 cm

Art. **F433** - P. 297  
Per mobile da L 141 a 170 cm

Art. **F434** - P. 297  
Per mobile da L 171 a 190 cm

Art. **F435** - P. 297  
Per mobile da L 191 a 220 cm

Art. **F436** - P. 297  
Per mobile da L 221 a 230 cm

## Ovale 57

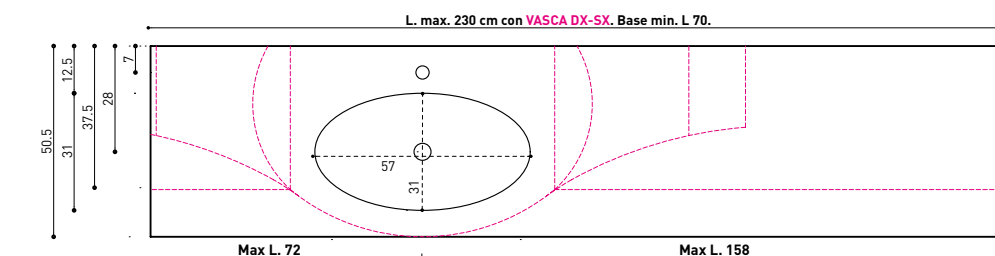
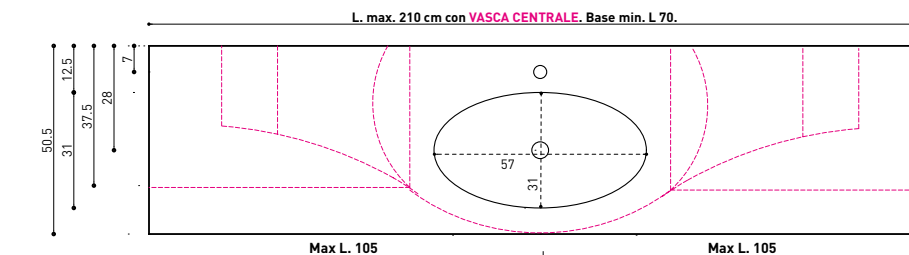



## Zen a terra - free standing

Lavabo ZEN / floor-standing washbasin / lavabo à poser au sol

Finiture / finishes / finitions:

quarzo resina Rocface:



QUARZO RESINA ROCFACE **TAUPE**



QUARZO RESINA ROCFACE **FANGO**

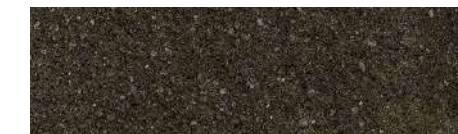

QUARZO RESINA ROCFACE **TORBA**



QUARZO RESINA ROCFACE **GRIGIO SASSO**



QUARZO RESINA ROCFACE **GREIGE**

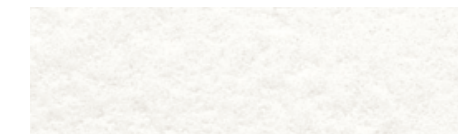

QUARZO RESINA ROCFACE **SUPERWHITE**

gres:

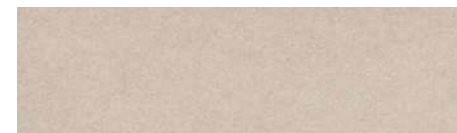

IRIS **IVORY**



IRIS **SILVER**



IRIS **PLUMB**



IRIS **AMBER**



IRIS **CALACATTA OPACO**



IRIS **BIANCO VENATO OPACO**



IRIS **GAUDI STONE LUCIDO**

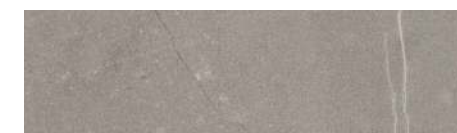

FLORIM **AMANI LUCIDO**



FLORIM **TRAVERTINO LUCIDO**

> A terra con foro per rubinetto /  
with hole for mixer /  
au sol avec trou pour robinet  
Art. **A641** - P. 268

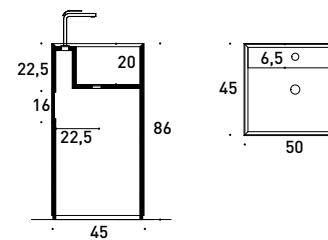

> Per rubinetto a terra /  
for floor-standing mixer /  
pour robinet au sol  
Art. **A642** - P. 268

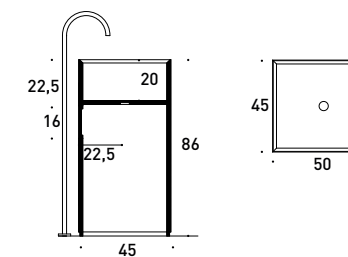



## Zen a terra - appoggio a muro

Lavabo ZEN / floor-standing washbasin to the wall / lavabo à poser au sol appuyé au mur

Finiture / finishes / finitions:

quarzo resina Rocface:



QUARZO RESINA ROCFACE **TAUPE**



QUARZO RESINA ROCFACE **FANGO**



QUARZO RESINA ROCFACE **TORBA**



QUARZO RESINA ROCFACE **GRIGIO SASSO**

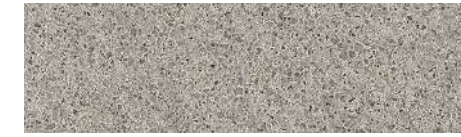

QUARZO RESINA ROCFACE **GREIGE**



QUARZO RESINA ROCFACE **SUPERWHITE**

gres:



IRIS **IVORY**



IRIS **SILVER**



IRIS **PLUMB**



IRIS **AMBER**



IRIS **CALACATTA OPACO**



IRIS **BIANCO VENATO OPACO**



IRIS **GAUDI STONE LUCIDO**



FLORIM **AMANI LUCIDO**



FLORIM **TRAVERTINO LUCIDO**

> A terra con foro per rubinetto /  
with hole for mixer /  
au sol avec trou pour robinet  
Art. **A834** - P. 268

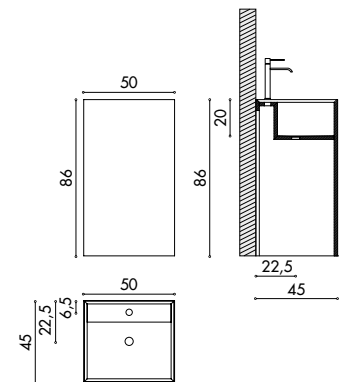

> Per rubinetto a parete /  
with mixer on the wall /  
pour robinet au mur  
Art. **A835** - P. 268

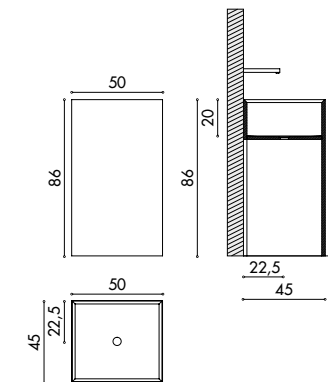



## Zen appoggio

Lavabo ZEN senza foro per rubinetto completo di staffe di fissaggio /  
wall-hung ZEN washbasin without tap hole cutout and fixing brackets /  
lavabo ZEN à poser sans trou pour robinet avec kit de fixation

Finiture / finishes / finitions:

gres:



quarzo resina Rocface:

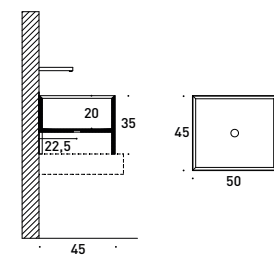
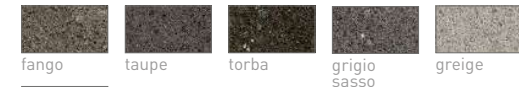

Art. **A644** - P. 268



## Zen appoggio CORIAN

Lavabo ZEN senza foro per rubinetto completo di staffe di fissaggio /  
wall-hung ZEN washbasin without tap hole cutout and fixing brackets /  
lavabo ZEN à poser sans trou pour robinet avec kit de fixation

Finiture / finishes / finitions:

corian:

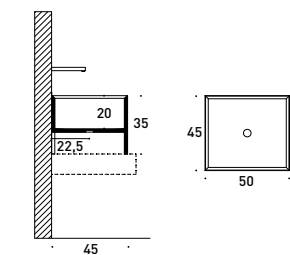

Art. **A644** - P. 268



## Zen appoggio

Lavabo ZEN con foro per rubinetto completo di staffe di fissaggio /  
wall-hung ZEN washbasin with tap hole cutout and fixing brackets /  
lavabo ZEN à poser avec trou pour robinet avec kit de fixation

Finiture / finishes / finitions:

gres:



quarzo resina Rocface:

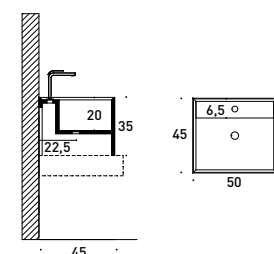
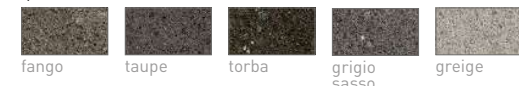

Art. **A643** - P. 268



## Mantra

Lavabo MANTRA con foro per rubinetto /  
wall-hung MANTRA washbasin with tap hole /  
lavabo MANTRA à poser avec trou pour robinet

Finiture / finishes / finitions:

gres:



quarzo resina Rocface:

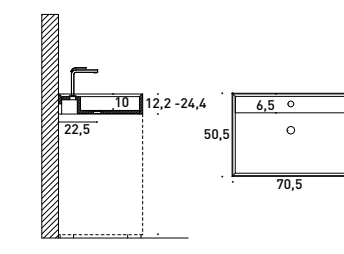
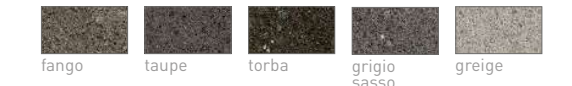

H 12,2 - Art. **A639** - P. 268

H 24,4 - Art. **A640** - P. 268



MIRRORS  
MIROIRS

# SPECCHIERE



## Light

Specchiera LIGHT con profilo in alluminio /  
Mirror LIGHT with aluminium frame /  
miroir LIGHT avec profil en aluminium.

Spessore 2,7 cm / Thick 2,7 cm / Épaisseur 2,7 cm

È possibile realizzare specchiere Light fuori misura (vedi listino) /  
it is possible to realize Light mirrors oversize (see pricelist) /  
il est possible de réaliser des miroirs Light sur mesure (voir tarif)

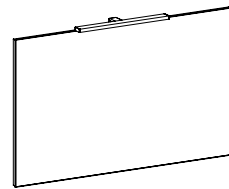

Con faretto MIKY 50 (V916) di serie /  
with standard spotlight MIKY 50 (V916) /  
avec spot MIKY 50 (V916) de série

Art. **S937** - P. 226  
L 60 x H 49 cm

Art. **S940** - P. 226  
L 70 x H 49 cm

Art. **S943** - P. 226  
L 85 x H 49 cm

Art. **S946** - P. 226  
L 95 x H 49 cm

Art. **S260** - P. 226  
L 60 x H 61,2 cm

Art. **S261** - P. 226  
L 70 x H 61,2 cm

Art. **S262** - P. 226  
L 85 x H 61,2 cm

Art. **S263** - P. 226  
L 95 x H 61,2 cm

Art. **S938** - P. 226  
L 60 x H 73,4 cm

Art. **S941** - P. 226  
L 70 x H 73,4 cm

Art. **S944** - P. 226  
L 85 x H 73,4 cm

Art. **S947** - P. 226  
L 95 x H 73,4 cm

Art. **S949** - P. 226  
L 105 x H 49 cm

Art. **S952** - P. 226  
L 120 x H 49 cm

Art. **S955** - P. 226  
L 130 x H 49 cm

Art. **S958** - P. 226  
L 140 x H 49 cm

Art. **S264** - P. 226  
L 105 x H 61,2 cm

Art. **S265** - P. 226  
L 120 x H 61,2 cm

Art. **S266** - P. 226  
L 130 x H 61,2 cm

Art. **S267** - P. 226  
L 140 x H 61,2 cm

Art. **S950** - P. 226  
L 105 x H 73,4 cm

Art. **S953** - P. 226  
L 120 x H 73,4 cm

Art. **S956** - P. 226  
L 130 x H 73,4 cm

Art. **S959** - P. 226  
L 140 x H 73,4 cm

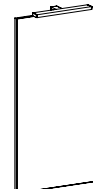

Con faretto MIKY 35 (V116) di serie /  
with standard spotlight MIKY 35 (V116) /  
avec spot MIKY 35 (V116) de série

Art. **S960** - P. 226  
L 36,8 x H 95 cm

Art. **S961** - P. 226  
L 49 x H 95 cm

Art. **S962** - P. 226  
L 55,4 x H 95 cm







## Tao

Specchiera TAO con profilo in alluminio e luce led perimetrale /  
Mirror TAO with aluminium frame and perimeter led /  
miroir TAO avec profil en aluminium et led isopérimètre.

Spessore 3 cm / Thick 3 cm / Épaisseur 3 cm

È possibile realizzare specchiere TAO fuori misura (vedi listino) /  
it is possible to realize TAO mirrors oversize (see pricelist) /  
il est possible de réaliser des miroirs TAO sur mesure (voir tarif)

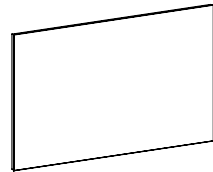

Non è possibile aggiungere faretti alla specchiera /  
No spotlight available for this mirror /  
Il est impossible d'ajouter des spots au miroir

Art. **S751** - P. 227  
L 60 x H 61,2 cm

Art. **S753** - P. 227  
L 70 x H 61,2 cm

Art. **S755** - P. 227  
L 85 x H 61,2 cm

Art. **S757** - P. 227  
L 95 x H 61,2 cm

Art. **S752** - P. 227  
L 60 x H 73,4 cm

Art. **S754** - P. 227  
L 70 x H 73,4 cm

Art. **S756** - P. 227  
L 85 x H 73,4 cm

Art. **S758** - P. 227  
L 95 x H 73,4 cm

Art. **S759** - P. 227  
L 105 x H 61,2 cm

Art. **S761** - P. 227  
L 120 x H 61,2 cm

Art. **S763** - P. 227  
L 130 x H 61,2 cm

Art. **S765** - P. 227  
L 140 x H 61,2 cm

Art. **S760** - P. 227  
L 105 x H 73,4 cm

Art. **S762** - P. 227  
L 120 x H 73,4 cm

Art. **S764** - P. 227  
L 130 x H 73,4 cm

Art. **S766** - P. 227  
L 140 x H 73,4 cm





## Light tonda

Specchiera LIGHT tonda /  
round LIGHT mirror /  
miroir Light tonde

Spessore 2,2 cm / Thick 2,2 cm / Épaisseur 2,2 cm

Optional: luce led perimetrale /  
On demand: perimeter led  
Sur demande: éclairage à leds périmétral



Art. **S268** - P. 237  
ø 30 cm

Art. **S269** - P. 237  
ø 40 cm

Senza faretto /  
without spotlight /  
sans spot

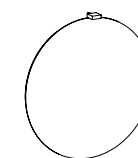

Art. **S113** - P. 237  
ø 68 cm

Art. **S112** - P. 237  
ø 85 cm

Art. **S278** - P. 237  
ø 100 cm

Con faretto THUNDER (V832) di serie /  
with standard spotlight THUNDER (V832) /  
avec spot THUNDER (V832) de série

## Sole

Specchiera SOLE dx-sx /  
SOLE mirror rh-lh /  
miroir SOLE droit-gauche

Spessore 2,2 cm / Thick 2,2 cm / Épaisseur 2,2 cm

Optional: luce led perimetrale /  
On demand: perimeter led  
Sur demande: éclairage à leds périmétral

Faretto di serie OFF art. V055 o led perimetrale /  
standard spotlight OFF art.V055 or perimetral led light /  
spot OFF art. V055 de série ou éclairage à leds périmétral

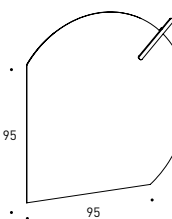

Art. **S128** - P. 239  
L 123,5 x H 123,5 cm



## Scia

Specchiera SCIA con profilo rivestito e fascia serigrafata e retroilluminata /  
SCIA mirror with aluminium coated profile, screen-printed screen and  
backlighting /  
miroir SCIA avec profil revêtu en aluminium at bande sérigraphiée et rétro-  
éclairé

Spessore 3 cm / Thick 3 cm / Épaisseur 3 cm

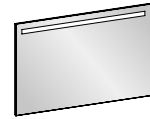

Art. **S901** - P. 229  
L 95 x H 61,2 cm

Art. **S902** - P. 229  
L 95 x H 73,4 cm

Art. **S903** - P. 229  
L 105 x H 61,2 cm

Art. **S904** - P. 229  
L 105 x H 73,4 cm

Art. **S905** - P. 229  
L 120 x H 61,2 cm

Art. **S906** - P. 229  
L 120 x H 73,4 cm

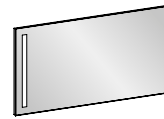

Art. **S907** - P. 229  
L 95 x H 61,2 cm

Art. **S908** - P. 229  
L 95 x H 73,4 cm

Art. **S909** - P. 229  
L 105 x H 61,2 cm

Art. **S910** - P. 229  
L 105 x H 73,4 cm

Art. **S911** - P. 229  
L 120 x H 61,2 cm

Art. **S912** - P. 229  
L 120 x H 73,4 cm

## Iride

Specchiera IRIDE con profilo in alluminio e luce led perimetrale /  
IRIDE mirror with aluminium profile and led light along the perimeter /  
miroir IRIDE avec profil en aluminium et éclairage à leds périmétral

Con faretto IRIDE (V832) di serie /  
with standard spotlight IRIDE (V832) /  
avec spot IRIDE (V832) de série

Spessore 2,6 cm / Thick 2,6 cm / Épaisseur 2,6 cm

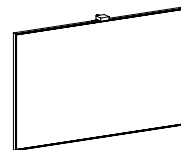

Art. **S063** - P. 228  
L 60 x H 61,2 cm

Art. **S064** - P. 228  
L 70 x H 61,2 cm

Art. **S065** - P. 228  
L 85 x H 61,2 cm

Art. **S066** - P. 228  
L 95 x H 61,2 cm

Art. **S067** - P. 228  
L 105 x H 61,2 cm

Art. **S068** - P. 228  
L 120 x H 61,2 cm

Art. **S069** - P. 228  
L 130 x H 61,2 cm

Art. **S070** - P. 228  
L 140 x H 61,2 cm

Art. **S449** - P. 228  
L 60 x H 73,4 cm

Art. **S450** - P. 228  
L 70 x H 73,4 cm

Art. **S451** - P. 228  
L 85 x H 73,4 cm

Art. **S452** - P. 228  
L 95 x H 73,4 cm

Art. **S453** - P. 228  
L 105 x H 73,4 cm

Art. **S454** - P. 228  
L 120 x H 73,4 cm

Art. **S455** - P. 228  
L 130 x H 73,4 cm

Art. **S456** - P. 228  
L 140 x H 73,4 cm





## Pulsar

Specchiera PULSAR con profilo in alluminio e luce LED sopra (su fascia satinata H 3,5 cm). Con interruttore touch (posizione fissa a DX) / PULSAR mirror with aluminium profile and LED light above (on satin-finished strip, H. 3.5 cm). With touch switch (fixed on RHS) / miroir PULSAR avec profil en aluminium et éclairage à LED au dessus (sur bande satiné H 3,5 cm). Avec interrupteur touch (position fixe à droite).

Spessore 2,6 cm / Thick 2,6 cm / Épaisseur 2,6 cm



Art. **S495** - P. 230  
L 85 x H 73,4 cm

Art. **S496** - P. 230  
L 95 x H 73,4 cm

Art. **S497** - P. 230  
L 105 x H 73,4 cm

Art. **S498** - P. 230  
L 120 x H 73,4 cm

Art. **S499** - P. 230  
L 130 x H 73,4 cm

Art. **S500** - P. 230  
L 140 x H 73,4 cm

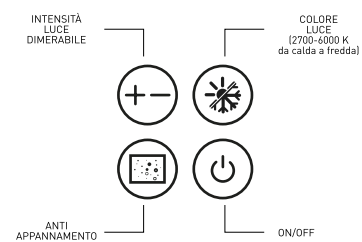

## Krea

Specchiera KREA con profilo in alluminio e luce LED sopra e sotto / KREA mirror with aluminium profile and LED light above and below / miroir KREA avec profil en aluminium et éclairage à LED au dessus et dessous

Spessore 2,6 cm / Thick 2,6 cm / Épaisseur 2,6 cm

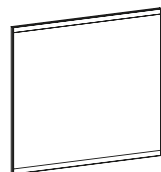

Art. **S487** - P. 230  
L 60 x H 73,4 cm

Art. **S488** - P. 230  
L 70 x H 73,4 cm

Art. **S489** - P. 230  
L 85 x H 73,4 cm

Art. **S490** - P. 230  
L 95 x H 73,4 cm

Art. **S491** - P. 230  
L 105 x H 73,4 cm

Art. **S492** - P. 230  
L 120 x H 73,4 cm

Art. **S493** - P. 230  
L 130 x H 73,4 cm

Art. **S494** - P. 230  
L 140 x H 73,4 cm





## Piper

Specchiera PIPER con profilo in legno e doppia illuminazione LED integrata sopra e sotto /  
PIPER mirror with wooden profile and integrated LED lighting above and below /  
miroir PIPER avec profil en bois et double éclairage à LEDS intégré dessus et dessous

Spessore 6 cm / Thick 6 cm / Épaisseur 6 cm

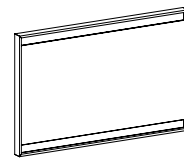

- Art. **S913** - P. 231  
L 70 x H 73,4 cm
- Art. **S914** - P. 231  
L 85 x H 73,4 cm
- Art. **S915** - P. 231  
L 95 x H 73,4 cm
- Art. **S351** - P. 231  
L 105 x H 73,4 cm
- Art. **S916** - P. 231  
L 120 x H 73,4 cm
- Art. **S917** - P. 231  
L 130 x H 73,4 cm
- Art. **S918** - P. 231  
L 140 x H 73,4 cm



## Lucy

Specchiera LUCY con unione a 45° e luce led integrata. Orizz./Vert. /  
LUCY mirror with 45° joint and built-in LED light. Horiz./Vert. /  
miroir LUCY avec union à 45° et éclairage à LEDS intégré. Horiz./Vert.

Spessore 6 cm / Thick 6 cm / Épaisseur 6 cm

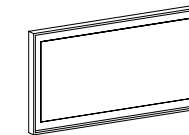

- Art. **S670** - P. 232  
L 70 x H 61,2 cm
- Art. **S671** - P. 232  
L 85 x H 61,2 cm
- Art. **S672** - P. 232  
L 95 x H 61,2 cm
- Art. **S673** - P. 232  
L 105 x H 61,2 cm
- Art. **S674** - P. 232  
L 120 x H 61,2 cm
- Art. **S675** - P. 232  
L 130 x H 61,2 cm
- Art. **S676** - P. 232  
L 140 x H 61,2 cm
- Art. **S677** - P. 232  
L 70 x H 170 cm
- Art. **S678** - P. 232  
L 70 x H 193,2 cm



## Bishop

Specchiera BISHOP con profilo in alluminio BRILL o alluminio rivestito rovere. Luce led perimetrale integrata. /  
BISHOP mirror with aluminium or oak-coated aluminium profile. Integrated perimeter LED light. /  
miroir BISHOP avec profil en aluminium BRILL ou aluminium revêtu en chêne. Éclairage à led périmétral intégré.

Spessore 4,5 cm / Thick 4,5 cm / Épaisseur 4,5 cm

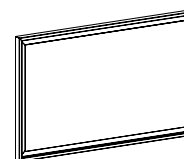

- Art. **S919** - P. 231  
L 60 x H 73,4 cm
- Art. **S920** - P. 231  
L 70 x H 73,4 cm
- Art. **S921** - P. 231  
L 85 x H 73,4 cm
- Art. **S922** - P. 231  
L 95 x H 73,4 cm
- Art. **S923** - P. 231  
L 105 x H 73,4 cm
- Art. **S924** - P. 231  
L 120 x H 73,4 cm
- Art. **S925** - P. 231  
L 130 x H 73,4 cm
- Art. **S350** - P. 231  
L 140 x H 73,4 cm



## Gabry

Specchiera GABRY con unione a 45° e luce led integrata. Orizz./Vert. /  
GABRY mirror with 45° joint and built-in LED light. Horiz./Vert. /  
miroir GABRY avec union à 45° et éclairage à LEDS intégré Horiz./Vert.

Spessore 15 cm / Thick 15 cm / Épaisseur 15 cm

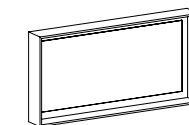

- Art. **S253** - P. 232  
L 70 x H 61,2 cm
- Art. **S254** - P. 232  
L 85 x H 61,2 cm
- Art. **S255** - P. 232  
L 95 x H 61,2 cm
- Art. **S256** - P. 232  
L 105 x H 61,2 cm
- Art. **S272** - P. 232  
L 120 x H 61,2 cm
- Art. **S273** - P. 232  
L 130 x H 61,2 cm
- Art. **S274** - P. 232  
L 140 x H 61,2 cm



## Maison

Specchiera MAISON con specchio bisellato e cornice in legno massiccio /  
 MAISON mirror with bevelled edge and frame in solid wood /  
 miroir MAISON avec miroir biseauté et cadre en bois massif

Spessore 2,2 cm / Thick 2,2 cm / Épaisseur 2,2 cm

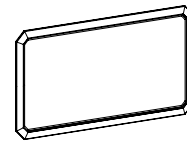

Art. **S427** - P. 233  
 L 95 x H 73,4 cm

Art. **S428** - P. 233  
 L 105 x H 73,4 cm

Art. **S429** - P. 233  
 L 140 x H 73,4 cm



## Tray

Specchiera TRAY con telaio in alluminio e cornice specchio. Orizz./Vert. /  
 TRAY mirror with aluminium structure and mirrored frame. Horiz./Vert. /  
 miroir TRAY avec cadre en aluminium et cadre miroir biseauté. Horiz./Vert.

Spessore 3,1 cm / Thick 3,1 cm / Épaisseur 3,1 cm

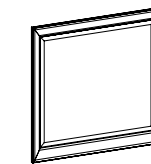

Art. **S138** - P. 234  
 L 70 x H 73,4 cm

Art. **S139** - P. 234  
 L 85 x H 73,4 cm

Art. **S230** - P. 234  
 L 95 x H 73,4 cm

Art. **S231** - P. 234  
 L 105 x H 73,4 cm

Art. **S232** - P. 234  
 L 120 x H 73,4 cm



## Woodline

Specchiera WOODLINE con cornice in alluminio con legno applicato L 1 cm /  
 WOODLINE mirror with aluminium frame with wood applied W 1 cm /  
 miroir WOODLINE avec cadre en aluminium avec bois appliqué L 1 cm

Spessore 3,1 cm / Thick 3,1 cm / Épaisseur 3,1 cm

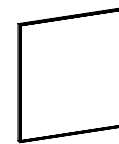

Art. **S473** - P. 233  
 L 60 x H 73,4 cm

Art. **S474** - P. 233  
 L 70 x H 73,4 cm

Art. **S475** - P. 233  
 L 85 x H 73,4 cm

Art. **S476** - P. 233  
 L 95 x H 73,4 cm

Art. **S477** - P. 233  
 L 105 x H 73,4 cm

Art. **S478** - P. 233  
 L 120 x H 73,4 cm

Art. **S479** - P. 233  
 L 130 x H 73,4 cm

Art. **S480** - P. 233  
 L 140 x H 73,4 cm



## Augusto

Specchiera AUGUSTO con cornice in legno L 8 cm. Orizz./Vert. /  
 AUGUSTO mirror with wood frame W 8 cm. Horiz./Vert. /  
 miroir AUGUSTO avec cadre en bois L 8 cm. Horiz./Vert.

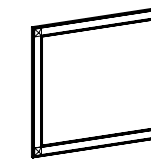

Art. **S339** - P. 234  
 L 70 x H 95 cm

Art. **S340** - P. 234  
 L 85 x H 95 cm

Art. **S341** - P. 234  
 L 95 x H 95 cm

Art. **S342** - P. 234  
 L 105 x H 95 cm

Art. **S343** - P. 234  
 L 120 x H 95 cm



## Stone

Spessore 2,2 cm / Thick 2,2 cm / Épaisseur 2,2 cm

Specchiera STONE orizzontale o verticale con bisello 2 cm / horizontally or vertically-fitted Light STONE with 2 cm bevelling / miroir STONE horizontal ou vertical avec biseau de 2 cm

Faretto di serie THUNDER (art. V832) o luce LED perimetrale / standard spotlight THUNDER (V832) or perimetral led light / avec spot THUNDER (V832) de série or éclairage à leds périmétral

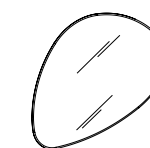

con luce LED  
Art. **S101** L 105 x H 88 cm  
(senza interruttore /  
no switch / sans interrupteur)



con luce LED  
Art. **S102** L 88 x H 105 cm  
(senza interruttore /  
no switch / sans interrupteur)

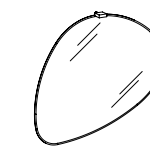

con faretto THUNDER  
Art. **S301** L 105 x H 88 cm  
(senza interruttore /  
no switch / sans interrupteur)



con faretto THUNDER  
Art. **S302** L 88 x H 105 cm  
(senza interruttore /  
no switch / sans interrupteur)



## Stone piccola

Spessore 2,2 cm / Thick 2,2 cm / Épaisseur 2,2 cm

Specchiera STONE PICCOLA orizzontale o verticale con bisello 2 cm / horizontally or vertically-fitted Light STONE PICCOLA with 2 cm bevelling / miroir STONE PICCOLA horizontal ou vertical avec biseau de 2 cm

Faretto di serie THUNDER (art. V832) o luce LED perimetrale / standard spotlight THUNDER (V832) or perimetral led light / avec spot THUNDER (V832) de série or éclairage à leds périmétral

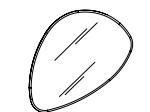

con luce LED  
Art. **S203** L 78 x H 66 cm  
(senza interruttore /  
no switch / sans interrupteur)



con luce LED  
Art. **S204** L 66 x H 78 cm  
(senza interruttore /  
no switch / sans interrupteur)



con faretto THUNDER  
Art. **S103** L 78 x H 66 cm  
(senza interruttore /  
no switch / sans interrupteur)



con faretto THUNDER  
Art. **S104** L 66 x H 78 cm  
(senza interruttore /  
no switch / sans interrupteur)



## Fancy - led perimetrale

Spessore 2,2 cm / Thick 2,2 cm / Épaisseur 2,2 cm

Specchiera FANCY con luce led perimetrale /  
FANCY mirror with perimeter LED light /  
miroir FANCY avec éclairage a LEDES périmétral

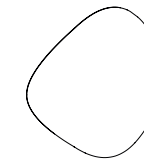

con luce **LED** / with **LED** / avec **LED**

Art. **S277** L 80 x H 80 cm - P. 237

[senza interruttore / no switch / sans interrupteur]



## Fancy - mini

Spessore 2,2 cm / Thick 2,2 cm / Épaisseur 2,2 cm

Specchiera FANCY senza luce led perimetrale /  
FANCY mirror without perimeter LED light /  
miroir FANCY sans éclairage a LEDES périmétral

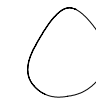

Art. **S276** L 40 x H 40 cm - P. 237

[senza interruttore / no switch / sans interrupteur]

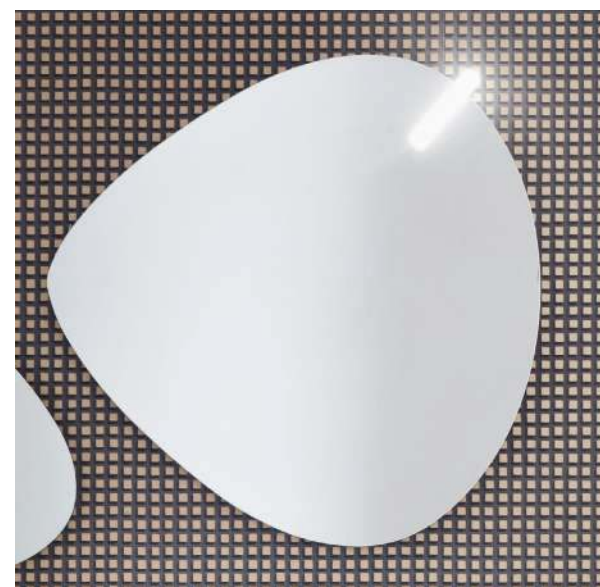

## Fancy - faretto ON

Spessore 2,2 cm / Thick 2,2 cm / Épaisseur 2,2 cm

Specchiera FANCY con faretto ON (V054) di serie /  
FANCY mirror with ON (led spotlight (V054) as standard /  
miroir FANCY avec spot ON (V054) de série

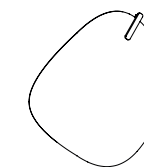

Art. **S280** L 80 x H 80 cm - P. 237

[senza interruttore / no switch / sans interrupteur]





## Play

Specchiera PLAY con cornice in vetro curvato e argentato a mano.  
Specchio interno L 70 x H 70 cm /  
PLAY mirror with curved mirror frame, silvered by hand. Actual mirror W 70 x H 70 cm. /  
miroir PLAY avec cadre en verre arrondi et argenté à main. Miroir interne L 70 x H 70 cm

Faretto di serie GENIUS led art. 6948 /  
standard spotlight GENIUS led item 6948 /  
spot GENIUS led art. 6948

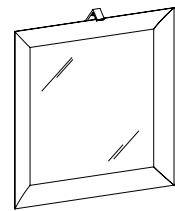

Art. **S226** - P. 235  
L 90 x H 90 cm  
{senza interruttore / no switch / sans interrupteur}



## Sail

Specchiera SAIL /  
SAIL mirror /  
miroir SAIL

Spessore 2,2 cm / Thick 2,2 cm / Épaisseur 2,2 cm

Faretto di serie THUNDER art. V832 /  
standard spotlight THUNDER art. V832 /  
spot THUNDER art. V832 de série

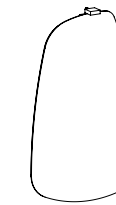

Art. **S303** - P. 239  
L 66/43 x H 105 cm  
{senza interruttore / no switch / sans interrupteur}



## Bora

Specchiera BORA dx-sx in metallo bianco opaco, con 3, 4 e 5 ripiani /  
BORA mirror, RHS or LHS in matt white metal, with 3,4 and 5 shelves /  
miroir BORA droit-gauche en métal blanc mat, avec 3,4 et 5 tablettes

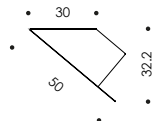

Art. **S437** - P. 235  
L 42 x H 95 cm

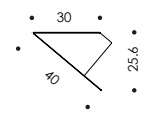

Art. **S438** - P. 235  
L 34,5 x H 120 cm

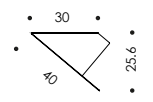

Art. **S439** - P. 235  
L 34,5 x H 171 cm



## Cuore

Specchiera CUORE /  
CUORE mirror /  
miroir CUORE

Spessore 2,2 cm / Thick 2,2 cm / Épaisseur 2,2 cm

Faretto di serie ON art. V054 /  
standard led spotlight ON art.V054 /  
leds spot ON art. V054 de série

Optional: luce led perimetrale /  
On demand: perimeter led  
Sur demande: éclairage à leds périmétral

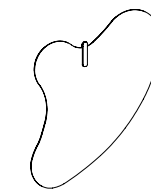

Art. **S090** - P. 239  
L 85 x H 100 cm  
{senza interruttore / no switch / sans interrupteur}



## Charme

Specchiera CHARME orizzontale o verticale con bisello a raggio variabile /  
CHARME mirror horizontal or vertical with bevelled edge with variable radius /  
miroir CHARME horizontal ou vertical avec biseau à rayon variable

Spessore 2,2 cm / Thick 2,2 cm / Épaisseur 2,2 cm

Optional: luce led perimetrale /  
On demand: perimeter led  
Sur demande: éclairage à led périmétral

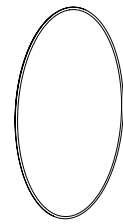

Art. **S122** - P. 238  
L 60 x H 105 cm  
(senza interruttore / no switch / sans interrupteur)



## Olimpia

Specchiera OLIMPIA in legno curvato sp. 7/3,5 cm /  
OLIMPIA mirror in curved wood, 7/3,5 cm thick /  
miroir OLIMPIA avec en bois arrondi ép. 7/3,5 cm

Optional: luce led perimetrale /  
On demand: perimeter led  
Sur demande: éclairage à led périmétral

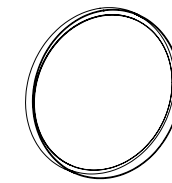

Art. **S413** - P. 238  
L 90 x H 90 cm  
(senza interruttore / no switch / sans interrupteur)



## Retrò

Specchiera RETRÒ orizzontale o verticale con bisello a raggio variabile /  
RETRÒ mirror horizontal or vertical with bevelled edge with variable radius /  
miroir RETRÒ horizontal ou vertical avec biseau à rayon variable

Spessore 2,2 cm / Thick 2,2 cm / Épaisseur 2,2 cm

Optional: luce led perimetrale /  
On demand: perimeter led  
Sur demande: éclairage à led périmétral

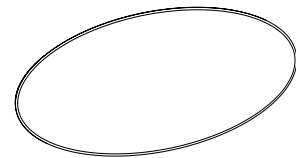

Art. **S040** - P. 238  
L 160 x H 70 cm  
(senza interruttore / no switch / sans interrupteur)



## Pliè

Specchiera PLIÈ in metallo bianco opaco sp. 7/2,7 cm /  
PLIÈ mirror in matt white metal, 7/2,7 cm thick /  
miroir PLIÈ en métal blanc mat ép. 7/2,7 cm

Optional: luce led perimetrale /  
On demand: perimeter led  
Sur demande: éclairage à led périmétral



Art. **S414** - P. 238  
L 60 x H 60 cm  
(senza interruttore / no switch / sans interrupteur)



## Ace - Ace 2

Specchiera ACE e ACE 2 (con led) con specchio curvato e argentato a mano.  
 Orizzontale o verticale /  
 ACE and ACE 2 (with LEDs) mirrors with curved mirror, silvered by hand.  
 Horizontal or vertical /  
 miroir ACE et ACE 2 (à LEDS) avec miroir arrondi et argenté à la main.  
 Horizontal ou vertical

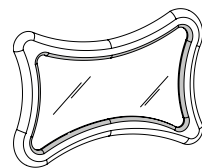

ACE  
 Art. **S117** - P. 240  
 L 120 x H 90 cm

ACE 2 - LED  
 Art. **S177** - P. 240  
 L 120 x H 90 cm

## Jolly

Specchiera JOLLY orizzontale o verticale con cornice in vetro nei colori della  
 Mazzetta 2016. Luce led integrata. /  
 JOLLY mirror horizontal or vertical with glass frame in the colours of the  
 2016 Palette, built-in led light /  
 miroir JOLLY horizontal ou vertical avec cadre en verre dans les coloris de la  
 palette 2016. Éclairage à leds intégré

Spessore 2,6 cm / Thick 2,6 cm / Épaisseur 2,6 cm

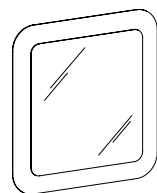

Art. **S167** - P. 239  
 L 70 x H 73,4 cm  
 [interruttore sotto / switch on the bottom / interrupteur en dessous]

Art. **S168** - P. 239  
 L 105 x H 73,4 cm  
 [interruttore sotto o destra / switch on the bottom or rh / interrupteur  
 en dessous ou à droite]





## Bon Bon

Specchiera BON BON con cornice a specchio curvato e argentato a mano.  
 Specchio interno L 80 x H 50 cm /  
 BON BON mirror with curved mirror frame, silvered by hand.  
 Actual mirror W 80 x H 50 cm /  
 miroirs BON BON avec cadre à miroir, arrondi et argenté à main.  
 Miroir interne L 80 x H 50 cm

Optional: luce led perimetrale /  
 On demand: perimeter led  
 Sur demande: éclairage à led périmétral

Art. **SV02** - P. 240  
 L 100 x H 69 cm  
 [senza interruttore / no switch / sans interrupteur]



## Diamante

Specchiera DIAMANTE orizzontale o verticale con frammenti di vetro argentato.  
 Specchio interno L 40 x H 70 cm /  
 DIAMANTE mirror horizontal or vertical with fragments of silvered glass.  
 Actual mirror W 40 x H 70 cm /  
 miroir DIAMANTE horizontal ou vertical avec fragments de verre argenté.  
 Miroir interne L 40 x H 70 cm.

Spessore 2 cm / Thick 2 cm / Épaisseur 2 cm

Art. **S121** - P. 240  
 L 60 x H 90 cm  
 [senza interruttore / no switch / sans interrupteur]



## Rose

Specchiera ROSE con cornice in faggio laccato opaco o Velvet. Orizzontale o verticale. Specchio interno L 53 x H 93 cm /  
ROSE mirror with matt or velvet lacquered beech frame. Horizontal or vertical. Actual mirror W 53 x H 93 cm /  
miroir ROSE avec cadre en hêtre laque mat ou velvet. Horizontal ou vertical. Miroir interne L 53 x H 93 cm

Optional: luce led perimetrale /  
On demand: perimeter led  
Sur demande: éclairage à led périmétral

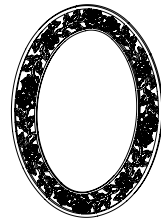

Art. **S048** - P. 241  
L 80 x H 120 cm  
(senza interruttore / no switch / sans interrupteur)

## Kent

Specchiera KENT con cornice in faggio laccato opaco o velvet. Specchio interno ø 58 cm /  
KENT mirror with matt or velvet lacquered beech frame. Actual mirror ø 58 cm /  
miroir KENT avec cadre en hêtre laccato mat ou velvet. Miroir interne ø 58 cm

Optional: luce led perimetrale /  
On demand: perimeter led  
Sur demande: éclairage à leds périmétral

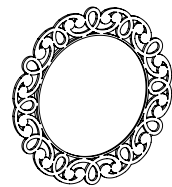

Art. **S080** - P. 241  
ø 85 cm  
(senza interruttore / no switch / sans interrupteur)





## Antibes

Specchiera ANTIBES con cornice in faggio laccato opaco o velvet.  
Specchio interno L 60 cm /  
ANTIBES mirror with matt or velvet lacquered beech frame. Internal mirror  
W 60 cm /  
miroir ANTIBES avec cadre en hêtre laqué mat ou velvet. Miroir interne L  
60 cm

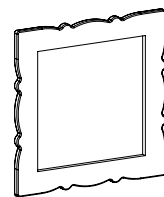

Art. **S463** - P. 241  
L 80 x H 80 cm  
(senza interruttore / no switch / sans interrupteur)



## Provence

Specchiera PROVENCE con cornice in faggio laccato opaco o velvet. Spec-  
chio interno L 105 x H 53 cm /  
PROVENCE mirror with matt or velvet lacquered beech frame. Internal  
mirror W 105 x H 53 cm /  
miroir PROVENCE avec cadre en hêtre laqué mat ou velvet. Miroir interne  
L 105 x H 53 cm

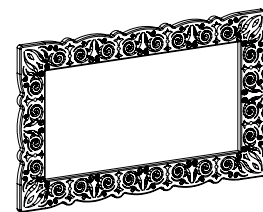

Art. **S464** - P. 241  
L 132 x H 80 cm  
(senza interruttore / no switch / sans interrupteur)





## Libra

Specchiera LIBRA con bisello e perni cromati basculanti /  
LIBRA mirror with bevelled edge and chrome tilting joints /  
miroir LIBRA avec biseau et axes chromés basculants

Spessore 8,5 cm / Thick 8,5 cm / Épaisseur 8,5 cm  
Sporgenza perni 7,3 cm / Pivot overhang W 7,3 cm / Épaisseur 8,5 cm

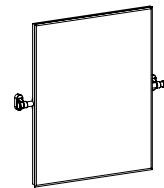

Art. **S186** - P. 240  
L 60 x H 73,4 cm

Art. **S187** - P. 240  
L 70 x H 73,4 cm





## Side

Specchiera SIDE con faretto Flash art. V818 led di serie e specchi interni /  
SIDE mirror-fronted cabinet standard with Flash spotlight item V818 and  
internal mirrors /  
miroir SIDE avec spot Flash à led art. V818 de série et miroirs internes

Profondità 18 cm / Depth 18 cm / Épaisseur 18 cm

Finiture / finishes / finitions:  
vedi listino Modelli 2017, pag. 243  
see Modelli 2017 pricelist, page 243  
voir tarif Modelli 2017, pag. 243

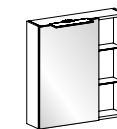

Art. **S540** - P. 243  
L 70 x H 73,4 cm

Art. **S541** - P. 243  
L 85 x H 73,4 cm

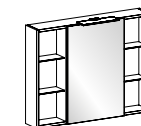

Art. **S542** - P. 243  
L 95 x H 73,4 cm

Art. **S543** - P. 243  
L 105 x H 73,4 cm

Art. **S544** - P. 243  
L 120 x H 73,4 cm

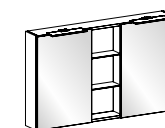

Art. **S566** - P. 243  
L 120 x H 73,4 cm

Art. **S545** - P. 243  
L 140 x H 73,4 cm





## Diva

Specchiera DIVA con faretto Flash art. V818 led di serie, specchi interni e spot-led/  
DIVA mirror-fronted cabinet standard with Flash spotlight item V818, internal mirrors and spot led /  
miroir DIVA avec spot Flash à led art. V818 de série, miroirs internes et spot leds.

Profondità 18 cm / Depth 18 cm / Épaisseur 18 cm

Finiture / finishes / finitions:  
vedi listino Modelli 2017, pag. 243  
see Modelli 2017 pricelist, page 243  
voir tarif Modelli 2017, pag. 243

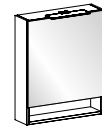

Art. **S546** - P. 243  
L 60 x H 73,4 cm

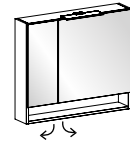

Art. **S547** - P. 243  
L 70 x H 73,4 cm

Art. **S548** - P. 243  
L 85 x H 73,4 cm

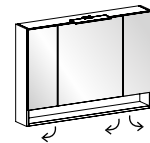

Art. **S549** - P. 243  
L 95 x H 73,4 cm

Art. **S550** - P. 243  
L 105 x H 73,4 cm

Art. **S551** - P. 243  
L 120 x H 73,4 cm

## Sintesi

Specchiera SINTESI con faretto Flash art. V818 led di serie e specchi interni /  
SINTESI mirror-fronted cabinet standard with Flash spotlight item V818  
and internal mirrors /  
miroir SINTESI avec spot Flash à led art. V818 de série et miroirs internes

Profondità 18 cm / Depth 18 cm / Épaisseur 18 cm

Finiture / finishes / finitions:  
vedi listino Modelli 2017, pag. 242  
see Modelli 2017 pricelist, page 242  
voir tarif Modelli 2017, pag. 242

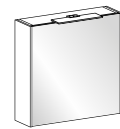

Art. **S552** - P. 242  
L 62,4 x H 61,2 cm

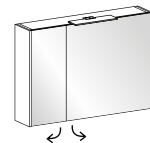

Art. **S553** - P. 242  
L 72,4 x H 61,2 cm

Art. **S554** - P. 242  
L 87,4 x H 61,2 cm

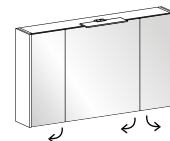

Art. **S555** - P. 242  
L 97,4 x H 61,2 cm

Art. **S556** - P. 242  
L 107,4 x H 61,2 cm

Art. **S557** - P. 242  
L 122,4 x H 61,2 cm



## Plus

Specchiera contenitore PLUS con 2 spot led /  
PLUS mirror with 2 LED spotlights /  
Miroir de rangement PLUS avec 2 spots led

Profondità 18 cm / Depth 18 cm / Épaisseur 18 cm

Finiture / finishes / finitions:  
vedi listino Modelli 2017, pag. 242  
see Modelli 2017 pricelist, page 242  
voir tarif Modelli 2017, pag. 242

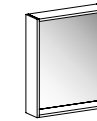

Art. **S365** - P. 242  
L 60 x H 73,4 x P 16 cm

Art. **S366** - P. 242  
L 70 x H 73,4 x P 16 cm

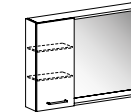

Art. **S367** - P. 242  
L 95 x H 73,4 cm

Art. **S368** - P. 242  
L 105 x H 73,4 cm

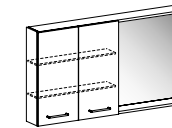

Art. **S369** - P. 242  
L 130 x H 73,4 cm

Art. **S370** - P. 242  
L 140 x H 73,4 cm





SPOTLIGHTS

SPOTS

FARETTI



## Metro

Faretto a luce led completo di alimentatore separato /  
Led spotlight complete with separate power supply /  
Spot avec éclairage à led avec alimentateur separé

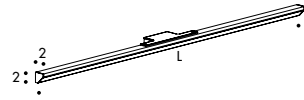

Art. **6943** - P. 245  
L / W / L **70** cm  
7 W - 12 V - 280 lux

Art. **6944** - P. 245  
L / W / L **95** cm  
9 W - 12 V - 330 lux

Art. **6945** - P. 245  
L / W / L **120** cm  
12 W - 12 V - 360 lux

Art. **6956** - P. 245  
L / W / L **140** cm  
14 W - 12 V - 390 lux

Art. **6957** - P. 245  
L / W / L **175** cm  
17 W - 12 V - 400 lux



## Dino

Faretto a luce led con alimentatore separato (solo per specchiere Light) /  
Led spotlight complete with separate power supply (only for Light mirrors) /  
Spot avec éclairage à led avec alimentateur intégré (uniquement pour miroirs Light)

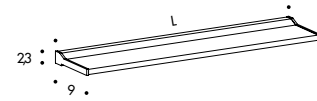

Art. **V027** - P. 245  
L / W / L **40** cm  
5,2 W - 300 lux

Art. **V014** - P. 245  
L / W / L **70** cm  
9,8 W - 450 lux

Art. **V066** - P. 245  
L / W / L **71-95** cm

Art. **V067** - P. 245  
L / W / L **96-120** cm

Art. **V068** - P. 245  
L / W / L **121-140** cm

Art. **V069** - P. 245  
L / W / L **141-175** cm



## Thunder

Faretto orientabile a luce led. Finitura cromo lucido.  
Completo di alimentatore separato /  
Adjustable led spotlight. Chrome finish.  
Complete with separate power supply /  
Spot orientable avec éclairage à led. Finition chrome brillant.  
Avec alimentateur separé.

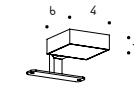

Art. **V832** - P. 246  
L / W / L **4** cm

12 V - 2,4 W - 250 lux - 4000 K (luce naturale / natural light / lumière naturelle)



## Emy

Faretto a luce led con struttura alluminio e metacrilato trasparente.  
Completo di alimentatore separato /  
Led spotlight with aluminium and transparent methacrylate structure.  
Complete with separate power supply /  
Spot avec éclairage à led avec structure en aluminium et méthacrylate transparent.  
Avec alimentateur separé.

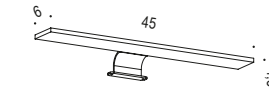

Art. **V610** - P. 245  
L / W / L **45** cm

12 V - 4 W - 400 lux - 4000 K (luce naturale / natural light / lumière naturelle)



## Miky 35

Faretto a luce led. Finitura brill.  
Alimentatore integrato /  
Led spotlight. Brill finish.  
Built-in power supply /  
Spot avec éclairage à led. Finition Brill.  
Avec alimentateur intégré.

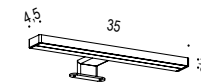

Art. **V116** - P. 245  
L / W / L **35** cm

230 V - 4,8 W - 400 lux - 4000 K (luce naturale / natural light / lumière naturelle)



## Miky 50

Faretto a luce led. Finitura brill.  
Alimentatore integrato /  
Led spotlight. Brill finish.  
Built-in power supply /  
Spot avec éclairage à led. Finition Brill.  
Avec alimentateur intégré.

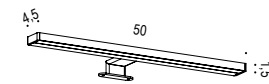

Art. **V916** - P. 245  
L / W / L **50** cm

230 V - 7,1 W - 500 lux - 4000 K (luce naturale / natural light / lumière naturelle)



## Island

Faretto a luce led con finitura cromo.  
Alimentatore integrato /  
Led spotlight with chrome finish.  
Built-in power supply /  
Spot avec éclairage à led avec finition chromo.  
Avec alimentateur intégré.

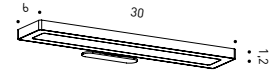

Art. **V830** - P. 246  
L / W / L 30 cm  
230 V - 8 W - 400 lux - 4000 K (luce naturale / natural light / lumière naturelle)



## Flash

Faretto a luce led con finitura acciaio mirror.  
Completo di alimentatore separato /  
Led spotlight with mirror steel finish.  
Complete with separate power supply /  
Spot avec éclairage à led, finition acier mirror.  
Avec alimentateur séparé.

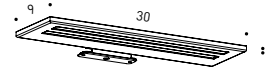

Art. **V818** - P. 247  
L / W / L 30 cm  
12 V - 5,5 W - 600 lux - 4000 K (luce naturale / natural light / lumière naturelle)



## Plano

Faretto a luce led. Finitura metacrilato e Brill.  
Alimentatore integrato /  
Led spotlight with methacrylate and brill finish.  
Built-in power supply /  
Spot avec éclairage à led, finition méthacrylate et Brill.  
Avec alimentateur intégré.

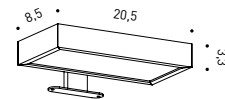

Art. **6923** - P. 246  
L / W / L 20,5 cm  
230 V - 8 W - 500 lux - 4000 K (luce naturale / natural light / lumière naturelle)



## Pill

Faretto a luce led con finitura acciaio mirror e cavo bianco effetto telato.  
Completo di alimentatore separato /  
Led spotlight with mirror steel finish and white wove.  
Complete with separate power-supply /  
Spot avec éclairage à led avec finition acier mirror et cable effet toile bianco.  
Avec alimentateur séparé.



Art. **V831** - P. 246  
L / W / L 8 cm  
12 V - 3,5 W - 300 lux - 4000 K (luce naturale / natural light / lumière naturelle)



## Saturno

Faretto a luce led. Finitura metacrilato e Brill.  
Completo di alimentatore separato /  
Led spotlight with methacrylate and brill finish.  
Complete with separate power-supply /  
Spot avec éclairage à led, finition méthacrylate et Brill.  
Avec alimentateur séparé.

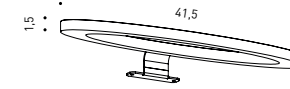

Art. **V056** - P. 246  
L / W / L 41,5 cm  
12 V - 17 W - 600 lux - 4000 K (luce naturale / natural light / lumière naturelle)



## On

Faretto a luce led. Finitura metacrilato e Brill.  
Completo di alimentatore separato /  
Led spotlight with methacrylate and brill finish.  
Complete with separate power-supply /  
Spot avec éclairage à led, finition méthacrylate et Brill.  
Avec alimentateur séparé.

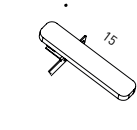

Art. **V054** - P. 246  
L / W / L 3 cm  
12 V - 3,3 W - 300 lux - 4000 K (luce naturale / natural light / lumière naturelle)



## Off

Faretto a luce led. Finitura metacrilato e Brill. Completo di alimentatore separato /  
Led spotlight with methacrylate and brill finish. Complete with separate power-supply /  
Spot avec éclairage à led, finition méthacrylate et Brill. Avec alimentateur séparé.

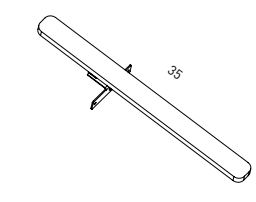

Art. **V055** - P. 246  
L / W / L 3 cm  
12 V - 8,2 W - 500 lux - 4000 K (luce naturale / natural light / lumière naturelle)



## Tiara

Faretto a luce led. Finitura metacrilato e Brill.  
Completo di alimentatore separato /  
Led spotlight with methacrylate and brill finish.  
Complete with separate power-supply /  
Spot avec éclairage à led, finition méthacrylate et Brill.  
Avec alimentateur séparé.

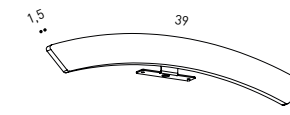

Art. **V057** - P. 247  
L / W / L 39 cm  
12 V - 8,2 W - 500 lux - 4000 K (luce naturale / natural light / lumière naturelle)



## Bius

Faretto a luce led. Struttura cromo e metacrilato satinato.  
Completo di alimentatore separato /  
Led spotlight with methacrylate and chrome finish.  
Complete with separate power-supply /  
Spot avec éclairage à led, finition méthacrylate et chrome.  
Avec alimentateur séparé.

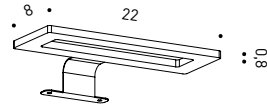

Art. **V833** - P. 247  
L / W / L 22 cm  
12 V - 12 W - 1000 lux - 4000 K (luce naturale / natural light / lumière naturelle)



## Trilly

Faretto a luce led con struttura bianca opaca. Alimentatore integrato /  
Led spotlight with matt white structure. Built-in power supply /  
Spot avec éclairage à led avec structure blanche mate. Avec alimentateur intégré.

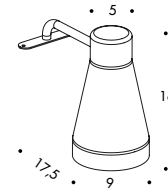

Art. **V008** - P. 247  
L / W / L 9 cm  
230 V - 4 W - 300 lux - 4000 K (luce naturale / natural light / lumière naturelle)



## Genius

Faretto a luce led con finitura cromo.  
Completo di alimentatore separato /  
Led spotlight with chrome finish complete.  
Separate power supply /  
Spot avec éclairage à led avec finition chromo.  
Alimentateur séparé.

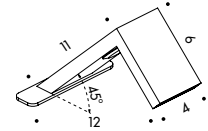

Art. **6948** - P. 247  
L / W / L 4 cm  
12 V - 2 x 1,2 W - 300 lux - 4000 K (luce naturale / natural light / lumière naturelle)



## Sfera singola

Faretto a luce led, struttura cromo con sfera in vetro trasparente /  
Led spotlight, chrome finish with transparent glass sphere /  
Spot avec éclairage à led, finition cromo avec sphère en verre transparent.

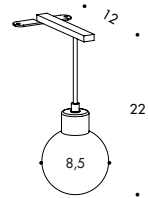

Art. **V024** - P. 247  
L / W / L 8,5 cm  
230 V - 3 W - 100 lux - 3000 K (luce calda / warm light / lumière chaude)



## Sfera doppia

Faretto a luce led, finitura cromo con sfere in vetro trasparente /  
Led spotlight, chrome finish with transparent glass spheres /  
Spot avec éclairage à led, finition chrome avec sphères en verre transparent.

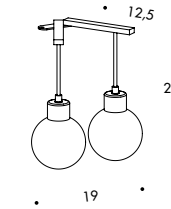

Art. **V025** - P. 247  
L / W / L 19 cm  
230 V - 2 x 3 W - 200 lux - 3000 K (luce calda / warm light / lumière chaude)



## Apollo

Faretto a luce led, struttura cromo con sfera in vetro trasparente (solo per specchiera AUGUSTO) /  
Led spotlight, chrome finish with transparent glass sphere (for AUGUSTO mirror only) /  
Spot avec éclairage à led, finition chrome avec sphère en verre transparent (uniquement pour miroir AUGUSTO).

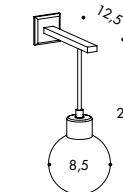

Art. **V029** - P. 248  
L / W / L 8,5 cm  
230 V - 3 W - 100 lux - 3000 K (luce calda / warm light / lumière chaude)



## Fiaccola bianca

Faretto a luce led, con struttura cromo e cappello bianco /  
Led spotlight, with chrome structure and white top /  
Spot avec éclairage à led avec structure en chrome et chapeau blanc.

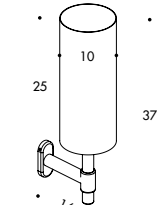

Il faretto Fiaccola può essere montato anche sulla cornice della specchiera Augusto /  
The Fiaccola spotlight can also be fitted onto the frame of the Augusto mirror /  
Le spot Fiaccola peut également être monté sur le cadre du miroir Augusto.

Art. **V021** - P. 249  
L / W / L 10 cm  
230 V - 5,3 W - 100 lux - 3000 K (luce calda / warm light / lumière chaude)



## Fiaccola nera

Faretto a luce led, con struttura cromo e cappello nero /  
Led spotlight, with chrome structure and black top /  
Spot avec éclairage à led avec structure en chrome et chapeau noir.

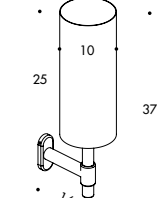

Il faretto Fiaccola può essere montato anche sulla cornice della specchiera Augusto /  
The Fiaccola spotlight can also be fitted onto the frame of the Augusto mirror /  
Le spot Fiaccola peut également être monté sur le cadre du miroir Augusto.

Art. **V021** - P. 249  
L / W / L 10 cm  
230 V - 5,3 W - 100 lux - 3000 K (luce calda / warm light / lumière chaude)



## Satin

Faretto a luce led con struttura cromo o oro e paralume in vetro satinato /  
Led spotlight with chrome or gold structure and lampshade in satin finish glass /  
Spot avec éclairage à led, finition chrome avec sphère en verre transparent.

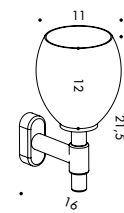

Il faretto Satin può essere montato anche sulla cornice della specchiera Augusto /  
The Satin spotlight can also be fitted onto the frame of the Augusto mirror /  
Le spot Satin peut également être monté sur le cadre du miroir Augusto.

Art. **V026** - P. 249  
L / W / L 11 cm

230 V - 5,3 W - 100 lux - 3000 K (luce calda / warm light / lumière chaude)



## Plano a muro

Faretto a luce led. Finitura metacrilato e Brill.  
Alimentatore integrato /  
Led spotlight with methacrylate and brill finish.  
Built-in power supply /  
Spot avec éclairage à led, finition méthacrylate et Brill.  
Avec alimentateur intégré.

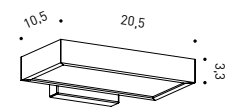

Art. **6924** - P. 249  
L / W / L 20,5 cm

230 V - 8 W - 500 lux - 4000 K (luce naturale / natural light / lumière naturelle)

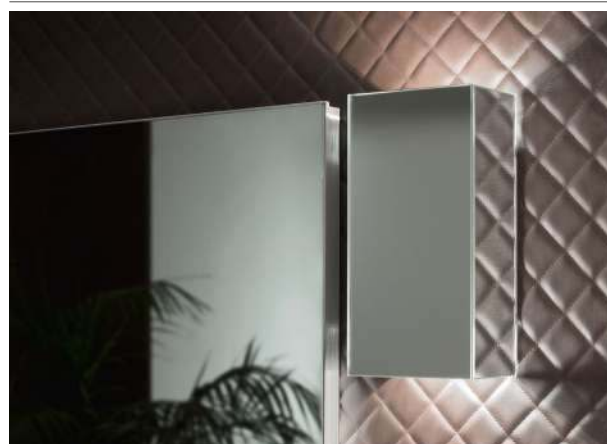

## Forma Specchio

Faretto a luce led con struttura rivestita specchio /  
Led spotlight with mirror-coated aluminium structure /  
Spot avec éclairage à led avec structure aluminium revêtu miroir.

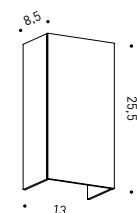

Art. **V061** - P. 249  
L / W / L 13 cm

230 V - 2 x 3,5 W - 100 lux - 4000 K (luce naturale / natural light / lumière naturelle)



## Forma Colore

Faretto a luce led con struttura alluminio bianco o nero /  
Led spotlight with black or white aluminium structure /  
Spot avec éclairage à led avec structure aluminium bianco ou nero.

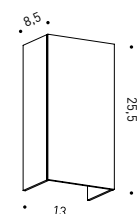

Art. **V062** - P. 249  
L / W / L 13 cm

230 V - 2 x 3,5 W - 100 lux - 4000 K (luce naturale / natural light / lumière naturelle)





## Ufo

Faretto al luce led, struttura cromo con sfera in vetro trasparente/  
Led spotlight, chrome finish with transparent glass sphere /  
Spot avec éclairage à led, finition cromo avec sphère en verre transparent.



Art. **V007** - P. 248  
L / W / L 12 cm  
230 V - 3 W - 100 lux - 3000 K (luce calda / warm light / lumière chaude)

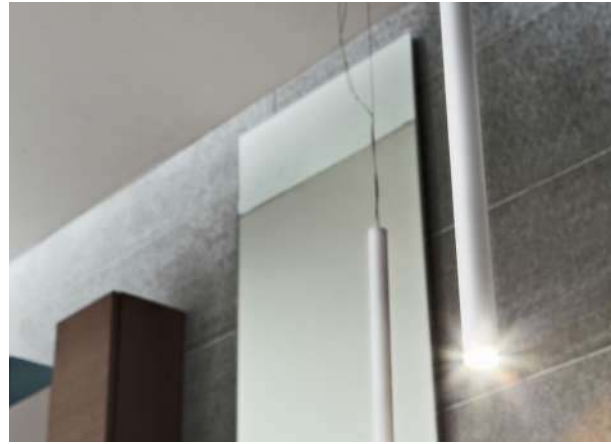

## Piro

Faretto a luce led con stelo in ottone verniciato bianco opaco H 40 cm.  
Cavo in acciaio L 180 cm e placca H 3 x ø 13 cm /  
Led spotlight with brass stem painted matt white H 40 cm.  
Steel cable L 180 and plate H 3 x ø 13 cm /  
Spot avec éclairage à led avec tige en laiton peint blanc mat H 40 cm.  
Câble en acier L 180 cm et plaque H 3 x ø 13 cm.

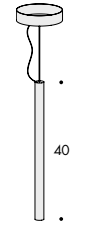

Art. **V608** - P. 248  
L / W / L 2,5 cm  
230 V - 2 W - 1000 lux - 4000 K (luce naturale / natural light / lumière naturelle)



## Trilly

Faretto a luce led con struttura bianca opaca /  
Led spotlight with matt white structure /  
Spot avec éclairage à led avec structure blanche mate.



Art. **V009** - P. 248  
L / W / L 9 cm  
230 V - 4 W - 300 lux - 4000 K (luce naturale / natural light / lumière naturelle)





ACCESSORIES  
ACCESSOIRES

# ACCESSORI





## Cassetti interni sagomati per basi portalavabo

Inner drawers for washbasin units

Tiroirs internes pour éléments sous lavabo

Cassetti interni sagomati per basi portalavabo H 49 o H 61,2 cm /  
Shaped inner drawers for washbasin units H 49 or H 61,2 cm /  
Tiroirs internes galbés pour éléments sous lavabo H 49 ou H 61,2 cm

P. 251

P. 37 cm  
D. 37 cm

Dimensioni base /  
base units dimensions /  
dimensions de l'élément bas  
**50 x 37 cm - Art. V205**

Dimensioni base /  
base units dimensions /  
dimensions de l'élément bas  
**60 x 37 cm - Art. V206**

Dimensioni base /  
base units dimensions /  
dimensions de l'élément bas  
**70 x 37 cm - Art. V207**

Dimensioni base /  
base units dimensions /  
dimensions de l'élément bas  
**85 x 37 cm - Art. V208**

Dimensioni base /  
base units dimensions /  
dimensions de l'élément bas  
**95 x 37 cm - Art. V209**

Dimensioni base /  
base units dimensions /  
dimensions de l'élément bas  
**105 x 37 cm - Art. V210**

Dimensioni base /  
base units dimensions /  
dimensions de l'élément bas  
**120 x 37 cm - Art. V212**

P. 50 cm  
D. 50 cm

Dimensioni base /  
base units dimensions /  
dimensions de l'élément bas  
**50 x 50 cm - Art. V215**

Dimensioni base /  
base units dimensions /  
dimensions de l'élément bas  
**60 x 50 cm - Art. V216**

Dimensioni base /  
base units dimensions /  
dimensions de l'élément bas  
**70 x 50 cm - Art. V217**

Dimensioni base /  
base units dimensions /  
dimensions de l'élément bas  
**85 x 50 cm - Art. V218**

Dimensioni base /  
base units dimensions /  
dimensions de l'élément bas  
**95 x 50 cm - Art. V219**

Dimensioni base /  
base units dimensions /  
dimensions de l'élément bas  
**105 x 50 cm - Art. V220**

Dimensioni base /  
base units dimensions /  
dimensions de l'élément bas  
**120 x 50 cm - Art. V222**



## Vassoio / Tray / Plateaux

Vassoio estraibile disponibile nelle finiture laccato bianco opaco, 49 colori opachi o velvet.  
 Per elementi L 35 e 50 x P 50 cm /  
 Pull-out tray available in matt bianco lacquer finish, 49 matt or velvet colours.  
 For elements W 35 e 50 x D 50 cm /  
 Plateaux extractible disponible avec les finitions laccato bianco mat, 49 coloris mats ou velvet.  
 Pour elements L 37 ou 50 x P 50 cm.

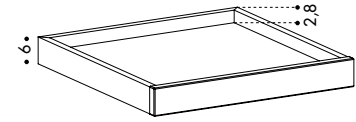

**Art. V132 - P. 250**  
 L 35 x H 6 x P 50 cm  
 W 35 x H 6 x D 50 cm  
 L 35 x H 6 x P 50 cm

**Art. V133 - P. 250**  
 L 50 x H 6 x P 50 cm  
 W 50 x H 6 x D 50 cm  
 L 50 x H 6 x P 50 cm

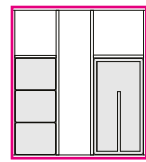

**Art. V223 - P. 251**  
 Cassetto  
 L 50 x P 50 cm

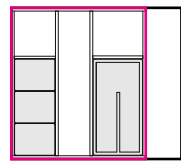

**Art. V224 - P. 251**  
 Cassetto  
 L 60 x P 50 cm

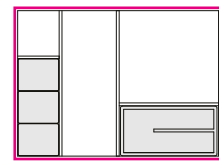

**Art. V225 - P. 251**  
 Cassetto  
 L 70 x P 50 cm

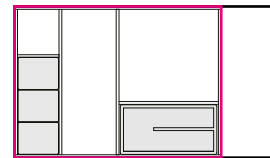

**Art. V226 - P. 251**  
 Cassetto  
 L 85 x P 50 cm

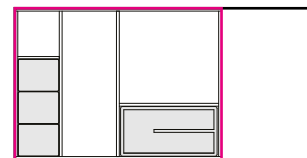

**Art. V227 - P. 251**  
 Cassetto  
 L 95 x P 50 cm

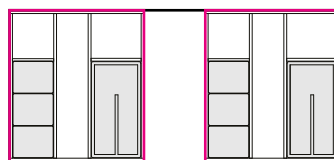

**Art. V228 - P. 251**  
 Cassetto  
 L 105 x P 50 cm

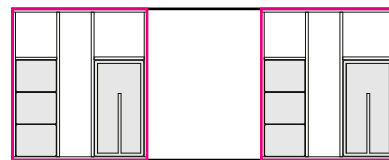

**Art. V229 - P. 251**  
 Cassetto  
 L 120 x P 50 cm

## Attrezzatura interna in legno

Internal accessories in wood

## Équipement interne en bois

Divisori per cassettoni P 50 cm in rovere bianco. Completo di tappetino gommatato, scatoline e vaschetta portaoggetti estraibile in plastica. /  
 Organizers for drawers W 50 in white oak. Rubber mat, plastic boxes and plastic glove box included /  
 Séparateurs pour les tiroirs P 50 cm en chêne blanc. Avec tapis en ca-outchouc, boîtes extractibles et 1 cuvette en plastique.



## Cestelli / Baskets / Paniers

Cestello portabiancheria a ribalta cromato. Apertura massima ribalta 33 cm /  
 Laundry basket chrome, tilt-out. Maximum opening of tilt-out door 33 cm /  
 Panier à linge abattant chromé. Ouverture maximale abattante 33 cm.

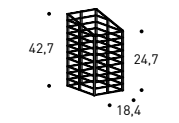

**Art. 5865 - P. 252**  
 Per basi L 25 x P 37 cm con anta H 49 - 61,2 - 73,4 cm  
 To use in base units W 25 x D 37 cm with door H 49 - 61,2 - 73,4 cm /  
 À insérer sur tous les éléments bas L 25 x P 37 avec porte H 49 - 61,2 - 73,4 cm

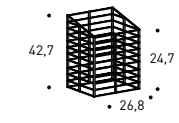

**Art. 5863 - P. 252**  
 Per basi L 35 x P 37 cm con anta H 49 - 61,2 - 73,4 cm  
 To use in base units W 35 x D 37 cm with door H 49 - 61,2 - 73,4 cm /  
 À insérer sur tous les éléments bas L 35 x P 37 avec porte H 49 - 61,2 - 73,4 cm

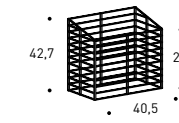

**Art. 5855 - P. 252**  
 Per basi L 50 x P 37/50 cm con anta H 49 cm  
 To use in base units W 50 x D 37/50 cm with door H 49 cm /  
 À insérer sur tous les éléments bas L 50 x P 37/50 avec porte H 49 cm

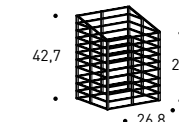

**Art. 5873 - P. 252**  
 Per basi L 50 x P 50/62 cm con anta H 73,4 cm /  
 To use in base units W 50 x D 50/62 cm with door H 73,4 cm /  
 À insérer sur tous les éléments bas L 50 x P 50/62 avec porte H 73,4 cm



## Portaphon

Portaphon da fissare all'interno dell'anta delle basi portalavabo (senza ripiano interno) /  
Hairdryer holder to be attached inside the door of the washbasin units (no internal shelf) /  
Porte sèche-cheveux à fixer l'intérieur de la porte de l'élément sous lavabo (sans tablette interne).

Art. **W016** - P. 252



## Vaschetta portaoggetti

Vaschetta portaoggetti da fissare all'interno dell'anta min. L 47,5 cm delle basi portalavabo. /  
Tray to be attached inside the door, min. 47,5 cm, of the washbasin unit /  
Cuvette porte-objets à fixer à l'intérieur de la porte min. L 47,5 cm de l'élément sous lavabo.

Art. **W017** - P. 252  
L 34 x H 6,5 x P 10 cm  
W 34 x H 6,5 x D 10 cm  
L 34 x H 6,5 x P 10 cm



## Vaschetta portaoggetti

Vaschetta portaoggetti da fissare all'interno dell'anta min. L 35 cm. /  
Tray to be attached inside the door, min. 35 cm /  
Cuvette porte-objets à fixer à l'intérieur de la porte min. L 35 cm.

Art. **W018** - P. 252  
L 26 x H 8 x P 10 cm  
W 26 x H 8 x D 10 cm  
L 26 x H 8 x P 10 cm

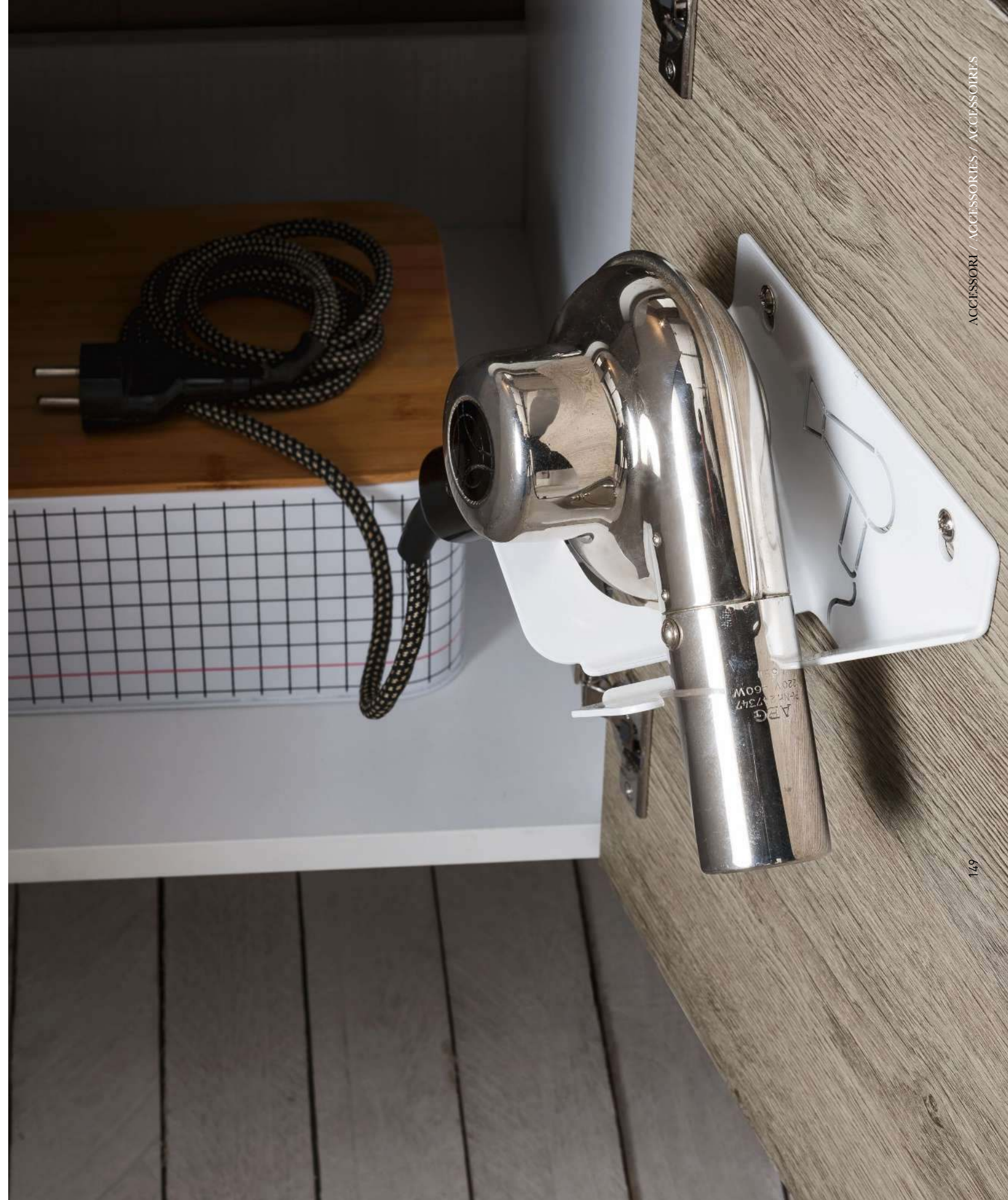



## Portatubo

Porta accessori + tubo aspirapolvere da fissare all'interno dell'anta delle colonne attrezzate min. L 50 cm /  
Accessory holder + hoover pipe to be attached inside the door of the fitted tall units, min. W 50 cm /  
Porte-accessoires + tuyau aspirateur à fixer à l'intérieur de la porte des colonnes équipées min. L 50 cm.

Art. **W019** - P. 252

## Ganci portascoppe

Ganci portascoppe L 35 cm da fissare all'interno dell'anta delle colonne min. L 50 cm /  
Brush hooks W 35 cm to be attached inside the door of the tall units, min. W 50 cm /  
Crochets porte-balais L 35 cm à fixer à l'intérieur de la porte des colonnes min. L 50 cm.

Art. **W020** - P. 252





## Mafalda

Portasalviette Mafalda applicabile sotto a piani H 3,6, 8, 12,2. Finitura brill. /  
Mafalda towel rail, to be used under tops H 3,6, 8, 12,2. Finish: brill. /  
Porte-serviettes Mafalda, applicable sous plans H 3,6, 8, 12,2. Finition Brill.

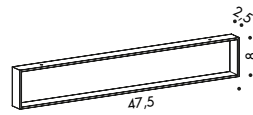

Art. **A325** - P. 254  
L / W / L 47,5 cm



## Maffy

Portasalviette Maffy applicabile sul fianco delle basi P 37, 50, 62 e 67,5 cm. Finitura brill. /  
Maffy towel rail, to be used on the side of base units D 37, 50, 62 e 67,5 cm. Finish: brill. /  
Porte-serviettes Maffy, applicable sur le côté des éléments bas P 37, 50, 62 et 67,5 cm. Finition Brill.

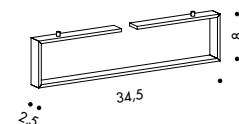

Art. **A211** - P. 254  
L / W / L 34,5 cm



## Linus

Portasalviette Linus per piani H 3,6, 8 o 12,2 cm. Finitura brill. /  
Linus towel rail, for tops H 3,6, 8 o 12,2 cm. Finish: brill. /  
Porte-serviettes Linus, pour plans H 3,6, 8 ou 12,2 cm. Finition Brill.

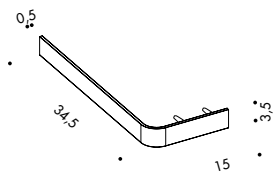

Art. **A432** - P. 254  
L / W / L 34,5 cm

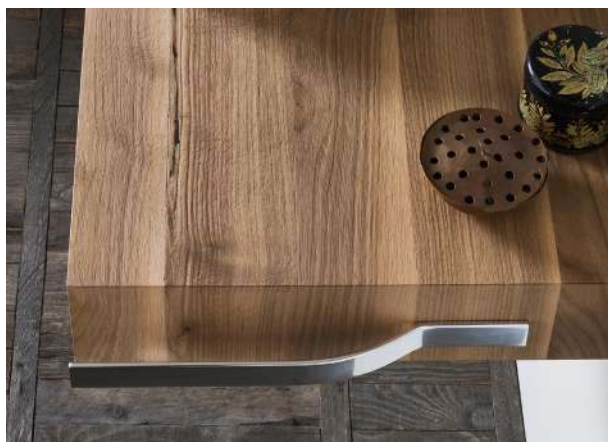

## Snoopy

Portasalviette Snoopy per mobili P 37 e 50 cm. Finitura brill. /  
Snoopy towel rail, for furniture D 37 or 50 cm. Finish: brill. /  
Porte-serviettes Snoopy, pour meubles P 37 ou 50 cm. Finition Brill.

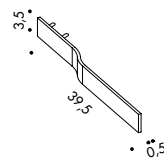

Art. **A431** - P. 254  
L / W / L 39,5 cm



## Fast curvo

Portasalviette Fast per fianco di tamponamento curvo. Finitura brill. /  
Fast towel rail for curved infill side. Finish: brill. /  
Porte-serviettes Fast pour élément arrondi. Finition brill.

Per fianchi di tamponamento art. V808 /  
For curved infill side item V808 /  
Pour élément arrondi art. V808.

Art. **A210** - P. 254



## Fusion

Portasalviette Fusion per fianco di tamponamento curvo. Finitura brill. /  
Fusion towel rail for curved infill side. Finish: brill. /  
Porte-serviettes Fusion pour élément arrondi. Finition brill.

Per fianchi di tamponamento art. V808 /  
For curved infill side item V808 /  
Pour élément arrondi art. V808.

Art. **A407** - P. 254



## Fast

Maniglione portasalviette Fast. Finitura brill. /  
Fast large handle towel rail. Finish: brill. /  
Grande poignée porte-serviettes Fast. Finition brill.

Per elementi L 50 e 60 cm /  
For elements W 50 and 60 cm /  
Pour élément L 50 et 60 cm.  
Art. **A205** - P. 255

Per elementi L 70 cm /  
For elements W 70 cm /  
Pour élément L 70 cm.  
Art. **A207** - P. 255

Per elementi L 85 cm /  
For elements W 85 cm /  
Pour élément L 85 cm.  
Art. **A208** - P. 255

Per elementi L 95 e 105 cm /  
For elements W 95 and 105 cm /  
Pour élément L 95 et 105 cm.  
Art. **A209** - P. 255

Per elementi L 120 cm /  
For elements W 120 cm /  
Pour élément L 120 cm.  
Art. **A212** - P. 255



## Sifone Millenium

Sifone Millenium con finitura cromo lucido /  
Millenium drain pipe with glossy chrome finish /  
Siphon Millenium avec finition chrome brillant.

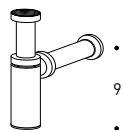

Art. **5692** - P. 256



## Sifone Millenium piccolo

Sifone Millenium piccolo con finitura cromo lucido /  
Small Millenium drain pipe with glossy chrome finish /  
Siphon Millenium piccolo avec finition chrome brillant.

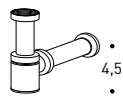

Art. **5697** - P. 256



## Sifone salvaspazio

Sifone Salvaspazio con finitura cromo lucido /  
Space-saving drain pipe with glossy chrome finish /  
Siphon dimensions réduites avec finition chrome brillant.

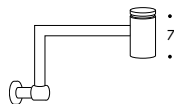

Art. **5709** - P. 256



## Piletta scarico libero

Piletta lavabo a scarico libero. Finitura cromo lucido. /  
Free draining washbasin plug. Glossy chrome finish /  
Bonde lavabo évacuation libre. Finition chrome brillant.

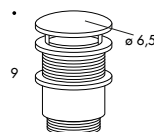

Art. **5699** - P. 256  
ø 6,5 cm



## Piletta "Stop & Go"

Piletta lavabo "Stop and Go". Finitura cromo lucido /  
Free draining washbasin plug. Glossy chrome finish /  
Bonde lavabo évacuation libre. Finition chrome brillant.

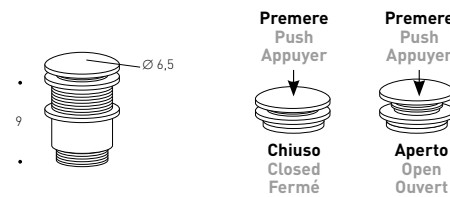

Art. **5698** - P. 256  
ø 6,5 cm



## Piletta "Stop & Go" in ceramica

Piletta lavabo "Stop & Go" in ceramica bianca /  
White ceramic "Stop & Go" plug /  
Bonde "Stop & Go" en céramique blanche.

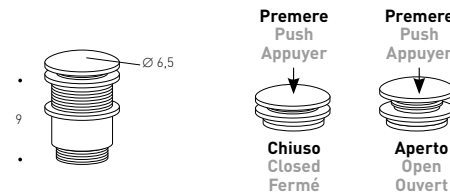

Art. **5694** - P. 256  
ø 6,5 cm



## Piletta "Stop & Go" in Corian

Piletta lavabo "Stop & Go" in Corian /  
Corian "Stop & Go" plug /  
Bonde "Stop & Go" en Corian.

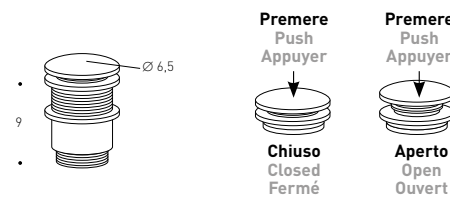

Art. **5696** - P. 256  
ø 6,5 cm



## Piletta "Stop & Go" in tekno/mineralguss

Piletta lavabo "Stop & Go" in mineralguss o tekno /  
"Stop & Go" plug in mineralguss or tekno /  
Bonde "Stop & Go" en mineralguss ou tekno.

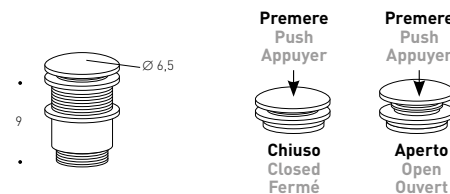

Art. **5696** - P. 256  
ø 6,5 cm



BATHTUBS  
BAIGNOIRES

VASCHE  
DA BAGNO



## Giulia

Vasca da bagno Giulia con piletta cromata Stop and Go e kit sifone. Senza troppo pieno.  
 Disponibile in mineralguss e in tekno. /  
 Giulia bathtub with Stop & Go chrome plug and drain kit. Without overflow hole.  
 Available in mineralguss and tekno. /  
 Baignoire Giulia avec bonde chromée Stop & Go et kit siphon (sans trop-plein).  
 En mineralguss ou tekno.

Art. **A457** - P. 308

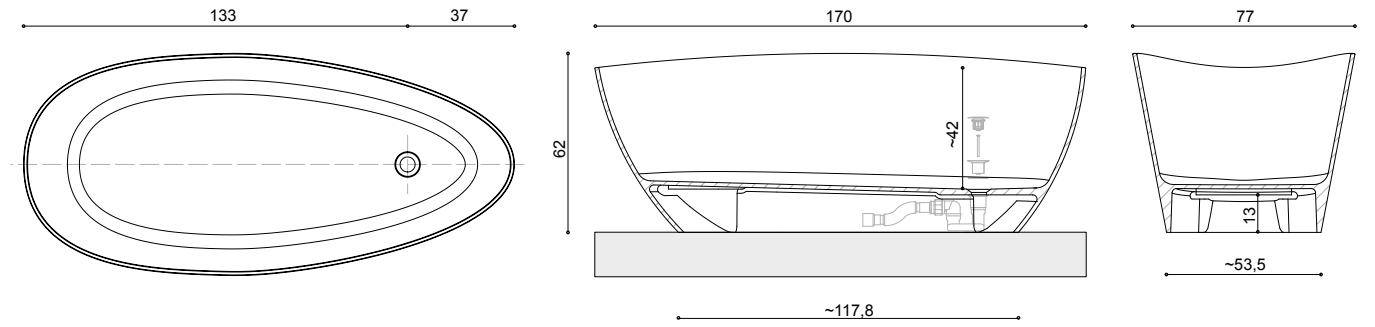

**ATTENZIONE! / ATTENTION!**  
**Rubinetto a muro o colonna a terra.**  
 Mixer on the wall or floor-standing mixer.  
 Robinet au mur ou colonne au sol.







## Tub

Vasca da bagno Tub con piletta cromata Stop and Go e kit sifone. Senza troppo pieno.  
 Disponibile in mineralguss. /  
 Tub bathtub with Stop & Go chrome plug and drain kit. Without overflow hole.  
 Available in mineralguss. /  
 Baignoire Tub avec bonde chromée Stop & Go et kit sphon (sans trop-plein).  
 En mineralguss.

Art. **A458** - P. 308

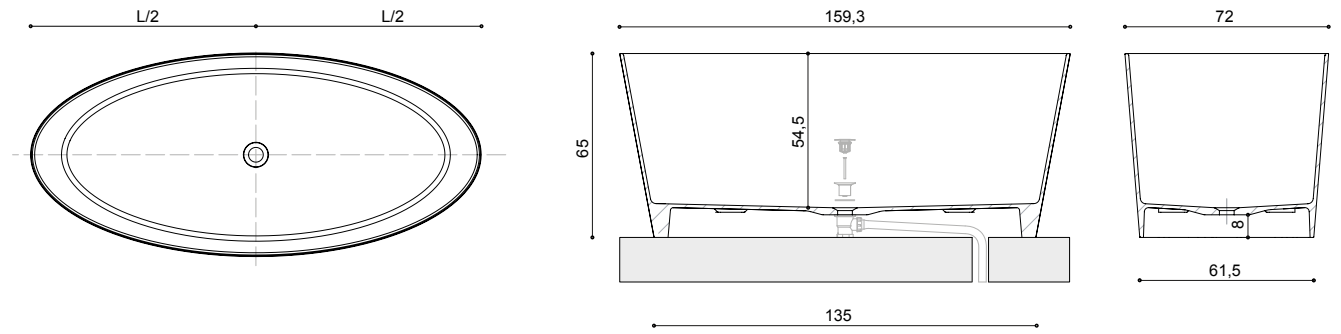

**ATTENZIONE! / ATTENTION!**  
**Rubinetto a muro o colonna a terra.**  
 Mixer on the wall or floor-standing mixer.  
 Robinet au mur ou colonne au sol.





## Egitto Piccola

Vasca da bagno Egitto Piccola con piletta cromata Stop and Go e kit sifone. Senza troppo pieno.  
 Disponibile in mineralguss. /  
 Egitto Piccola bathtub with Stop & Go chrome plug and drain kit. Without overflow hole.  
 Available in mineralguss. /  
 Baignoire Egitto Piccola avec bonde chromée Stop & Go et kit siphon (sans trop-plein).  
 En mineralguss.

Art. **A459** - P. 309

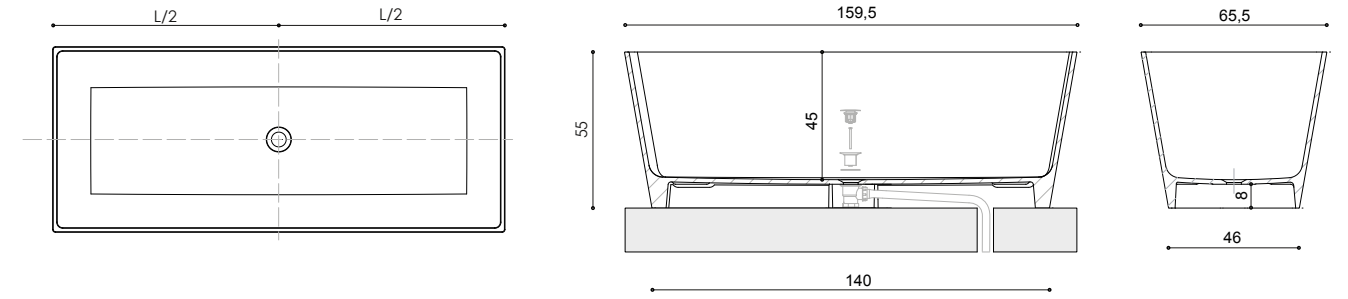

**ATTENZIONE! / ATTENTION!**  
**Rubinetto a muro o colonna a terra.**  
 Mixer on the wall or floor-standing mixer.  
 Robinet au mur ou colonne au sol.





## Tania

Vasca da bagno Tania con piletta cromata Stop and Go e kit sifone. Con troppo pieno integrato.  
 Disponibile in mineralguss. /  
 Tania bathtub with Stop & Go chrome plug and drain kit. With integrated overflow hole.  
 Available in mineralguss. /  
 Baignoire Tania avec bonde chromée Stop & Go et kit siphon. Avec trop-plein intégré.  
 En mineralguss.

Art. **A460** - P. 309

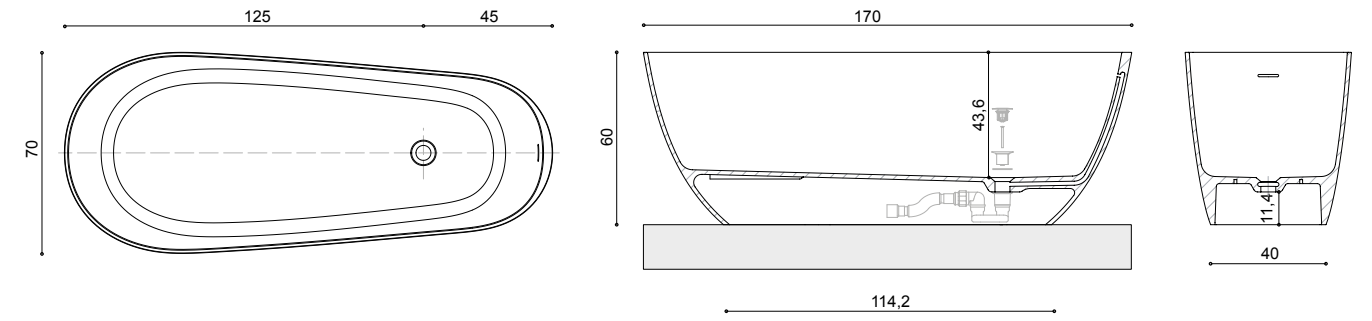

**ATTENZIONE! / ATTENTION!**  
**Rubinetto a muro o colonna a terra.**  
 Mixer on the wall or floor-standing mixer.  
 Robinet au mur ou colonne au sol.





## Kuvet - scarico centrale

Vasca da bagno Kuvet con piletta bianca Stop and Go e kit sifone. Con troppo pieno integrato.  
 Disponibile in mineralguss e in tekno. /  
 Kuvet bathtub with Stop & Go white plug and drain kit. With integrated overflow hole.  
 Available in mineralguss and tekno. /  
 Baignoire Kuvet avec bonde blanc Stop & Go et kit siphon (avec trop-plein intégré).  
 En mineralguss ou tekno.

Art. **A461** - P. 310

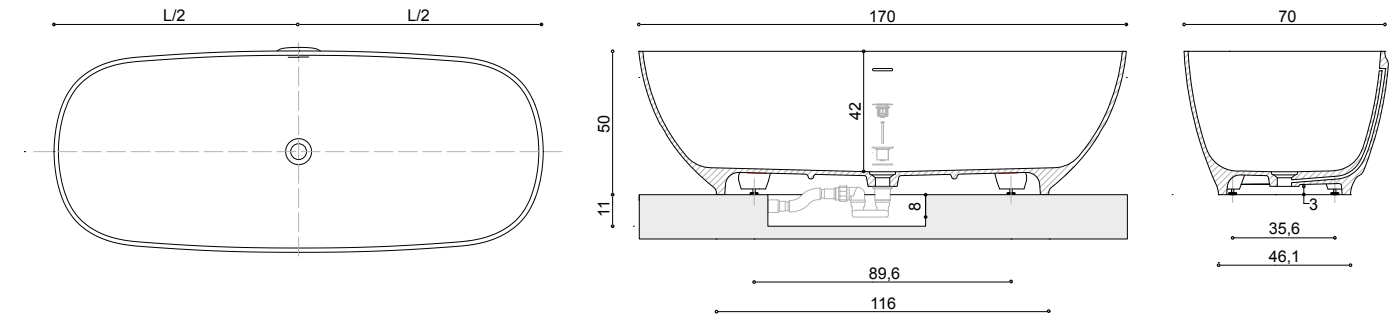

## Kuvet - scarico laterale

Vasca da bagno Kuvet con piletta bianca Stop and Go e kit sifone. Con troppo pieno integrato.  
 Disponibile in mineralguss e in tekno. /  
 Kuvet bathtub with Stop & Go white plug and drain kit. With integrated overflow hole.  
 Available in mineralguss and tekno. /  
 Baignoire Kuvet avec bonde blanc Stop & Go et kit siphon (avec trop-plein intégré).  
 En mineralguss ou tekno.

Art. **A462** - P. 310

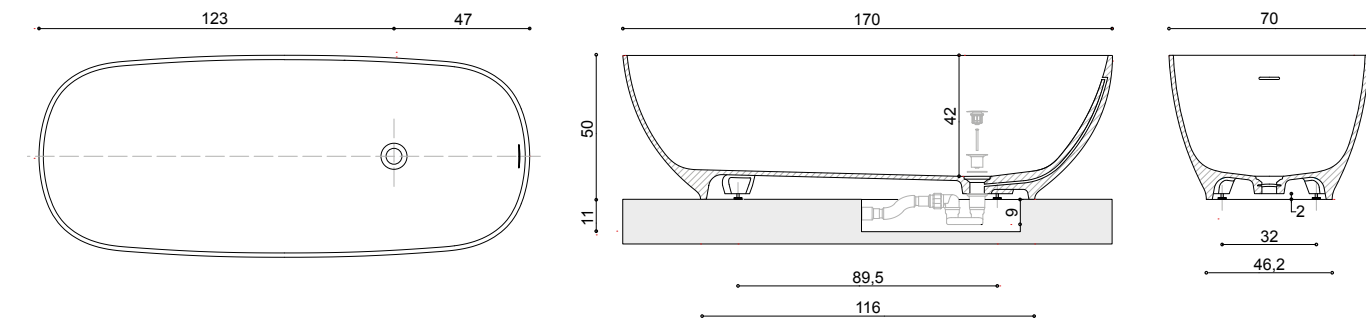

**ATTENZIONE! / ATTENTION!**  
**Rubinetto a muro o colonna a terra.**  
 Mixer on the wall or floor-standing mixer.  
 Robinet au mur ou colonne au sol.

**ATTENZIONE! / ATTENTION!**  
**Necessita di pozzetto per sifone.**  
 Requires catch basin for drain pipe.  
 Nécessite d'un regard pour siphon.



## Kuvet con zeppa

Vasca da bagno Kuvet con piletta bianca Stop and Go e kit sifone. Con troppo pieno integrato.  
 Disponibile in mineralguss e in tekno. /  
 Kuvet bathtub with Stop & Go white plug and drain kit. With integrated overflow hole.  
 Available in mineralguss and tekno. /  
 Baignoire Kuvet avec bonde blanc Stop & Go et kit siphon (avec trop-plein intégré).  
 En mineralguss ou tekno.

Art. **A463** - P. 311

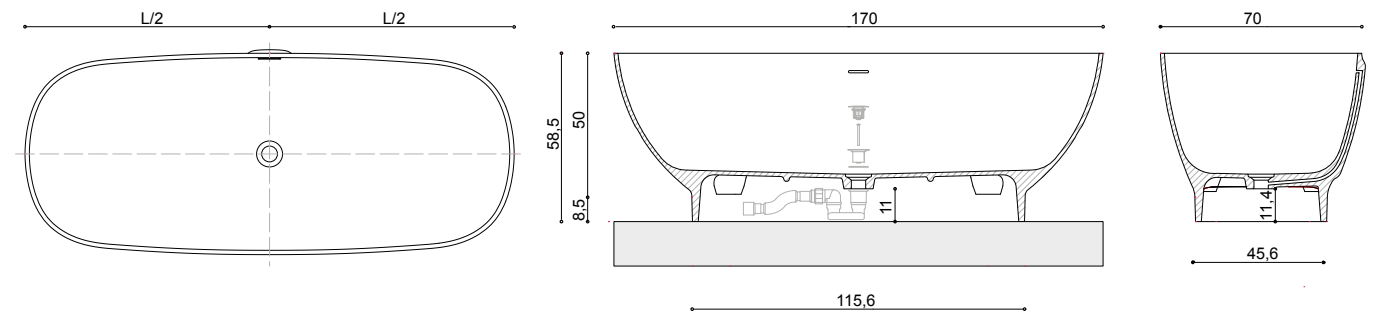

**⚠ ATTENZIONE! / ATTENTION!**  
**Rubinetto a muro o colonna a terra.**  
 Mixer on the wall or floor-standing mixer.  
 Robinet au mur ou colonne au sol.



## Kuvet piccola

Vasca da bagno Kuvet con piletta bianca Stop and Go e kit sifone. Con troppo pieno integrato.  
 Disponibile in mineralguss e in tekno. /  
 Kuvet bathtub with Stop & Go white plug and drain kit. With integrated overflow hole.  
 Available in mineralguss and tekno. /  
 Baignoire Kuvet avec bonde blanc Stop & Go et kit siphon (avec trop-plein intégré).  
 En mineralguss ou tekno.

Art. **A170** - P. 311

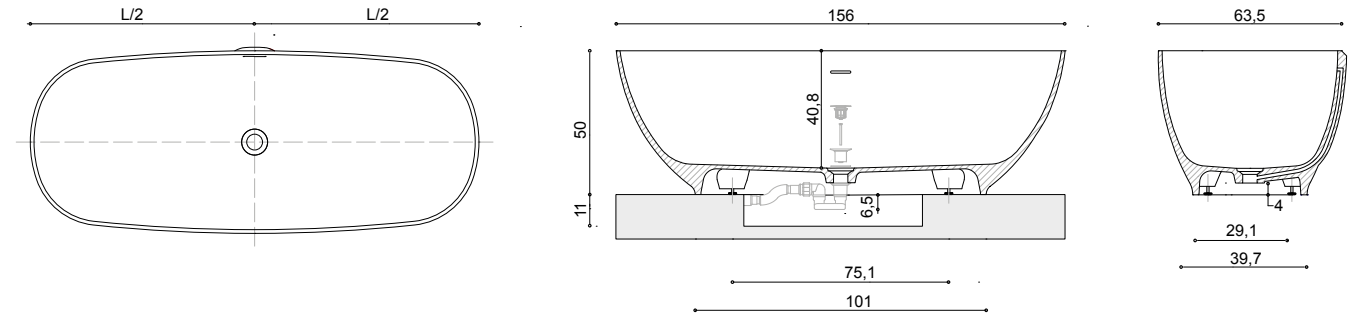

**ATTENZIONE! / ATTENTION!**  
**Rubinetti a muro o colonna a terra.**  
 Mixer on the wall or floor-standing mixer.  
 Robinet au mur ou colonne au sol.

**ATTENZIONE! / ATTENTION!**  
**Necessita di pozzetto per sifone.**  
 Requires catch basin for drain pipe.  
 Nécessite d'un regard pour siphon.



## Feeling

Vasca da bagno Feeling con piletta bianca Stop and Go e kit sifone. Con troppo pieno integrato.  
 Disponibile in mineralguss e in tekno. /  
 Feeling bathtub with Stop & Go white plug and drain kit. With integrated overflow hole.  
 Available in mineralguss and tekno. /  
 Baignoire Feeling avec bonde blanc Stop & Go et kit siphon (avec trop-plein intégré).  
 En mineralguss ou tekno.

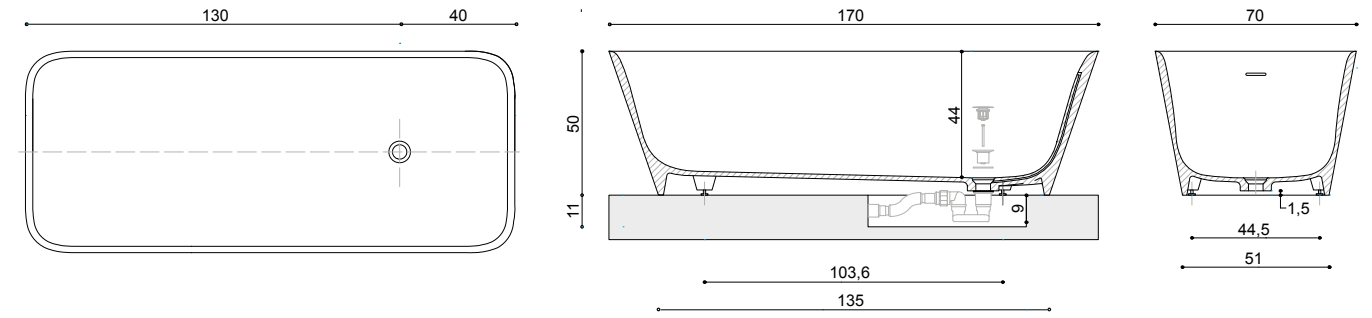

**ATTENZIONE! / ATTENTION!**  
**Rubinetto a muro o colonna a terra.**  
 Mixer on the wall or floor-standing mixer.  
 Robinet au mur ou colonne au sol.

**ATTENZIONE! / ATTENTION!**  
**Necessita di pozzetto per sifone.**  
 Requires catch basin for drain pipe.  
 Nécessite d'un regard pour siphon.



**⚠ ATTENZIONE! / ATTENTION!**  
 Necessita di pozzetto per sifone.  
 Requires catchbasin for drain pipe.  
 Nécessite d'un regard pour siphon.

**⚠ ATTENZIONE!**  
 Indicare lato posizione rubinetteria.  
 Fornire scheda tecnica per fori rubinetteria.  
 Specify tap position. Provide technical data sheet for tap holes.  
 Indiquer le coté de position de la robinetterie. Fournir fiche technique pour les trous de la robinetterie.

## Coccole

Vasca da bagno Coccole con piletta bianca Stop and Go e kit sifone. Con troppo pieno integrato.  
 Disponibile in mineralguss e in tekno. /  
 Coccole bathtub with Stop & Go white plug and drain kit. With integrated overflow hole.  
 Available in mineralguss and tekno. /  
 Baignoire Coccole avec bonde blanc Stop & Go et kit siphon (avec trop-plein intégré).  
 En mineralguss ou tekno.

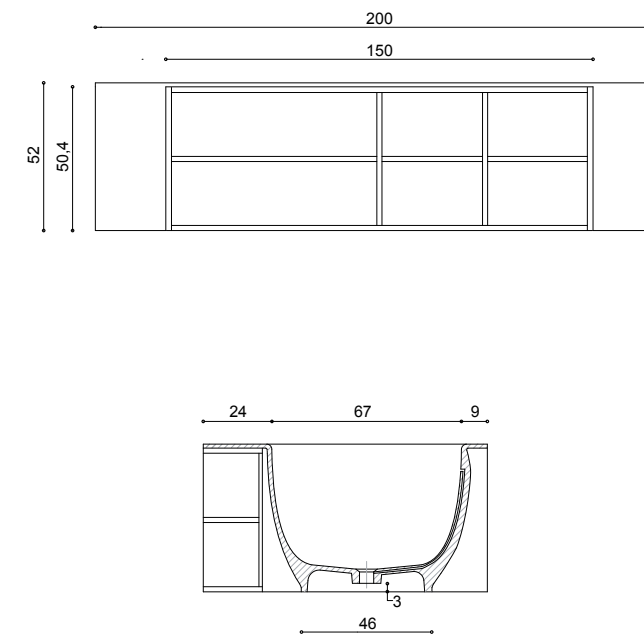
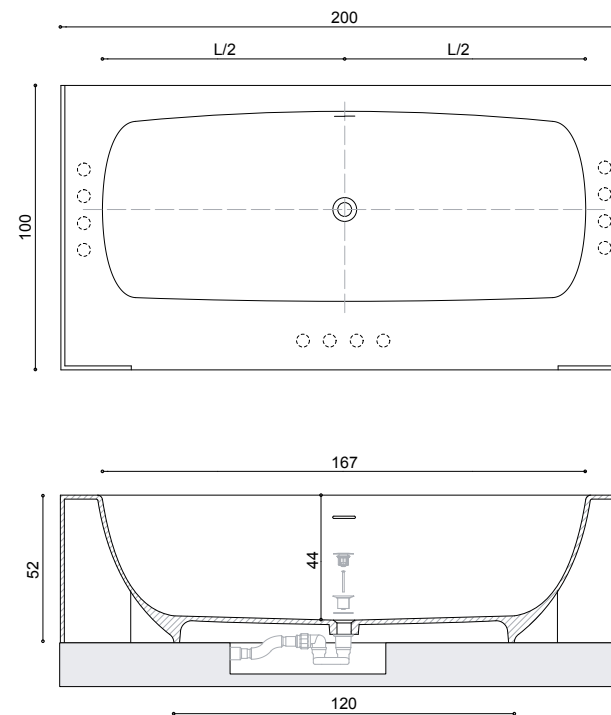



**design**

Ufficio Tecnico Arbi

**graphic design**

Ufficio Tecnico Arbi

**photography**

Photografica

Contratti Company

Auber

**color separation**

Lucegroup.it

**printed in italy**

AGCM - Prata di Pordenone

**Novembre 2017**

**ARBI**  
BATHROOM

**Arbi Arredobagno srl**

Viale Lino Zanussi, 34/A  
33070 Maron di Brugnera  
Pordenone - Italy  
Tel. +39 0434 624822  
Fax +39 0434 624991  
[www.arbiarredobagno.it](http://www.arbiarredobagno.it)

**ATMA**  
INDUSTRIE DEL MOBILE

